



# Electronic products for electrical panels

2017/2018 EDITION



 **cabur**<sup>®</sup>  
CONNECTING ENERGY  
SINCE 1952

# **Electronic products for electrical panels**

**2017-2018 Edition**



UNI EN-ISO 9001



UNI EN-ISO 14001

**WARNING** If not specified, the technical data in this catalogue are typical and measured at 25°C (77°F), 230 Vac, Unom, Vdc and rated current; ripple is measured at 20 MHz with probe connected to 0.1  $\mu$ F. The technical data in this catalogue are typical and are not binding for Cabur and may be modified without prior notice, simply for production or improvement and/or evolution reason. Please contact our technical-commercial offices for any relevant confirmation or updates. For more informations visit our web site [www.cabur.eu](http://www.cabur.eu).

# The Company

Founded in 1952, Cabur quickly gained the lead position among national manufacturers of terminal blocks for electrical panels, pursuing a policy which focused particularly on installers' needs and offering cutting-edge technological solutions.

With over 65 years of experience, Cabur develops and creates, based on its own designs, a vast array of products for the electro-technical and electronic industries famous for their reliability even under extreme conditions.

Our current production includes:

- terminal blocks and boards for electrical panels
- electronic products for electrical panels
- terminal blocks for civil and industrial installations
- products for photovoltaic systems
- industrial marking systems

which perfectly meet the various and complex installation needs of users.

Our production, which is wide and diversified, represents the optimal synthesis of Cabur's long experience as a supplier to the main national energy boards and companies, together with activities and collaboration abroad.

In pursuing a corporate culture based on Total Quality, Cabur has adopted the main European directives of the reference market, and collaborates with the most prestigious national and foreign Institutes and Laboratories.



## Introduction

Cabur .....	p.	3
-------------	----	---

## Power supplies

Introduction .....	p.	6
Quick selection table .....	p.	8
CSD series Domotic Power single-phase modular switching .....	p.	10
CSF series Cool Power single-phase switching .....	p.	15
Single-phase switching in IP65 case .....	p.	21
CSL series Easy Power single-phase switching .....	p.	22
CSW series Universal Power single-, 2- and 3-phase switching .....	p.	27
CSG series Triple Power 3-phase switching .....	p.	32
CSA series DC/DC switching converters .....	p.	39
With 24 Vac transformer input .....	p.	41
DC battery charger-UPS .....	p.	43
CSC series power supply with integrated battery charger .....	p.	47
Redundant connection accessory .....	p.	48
Engine braking control module .....	p.	50

## Overcurrent protection devices

Introduction .....	p.	52
Electronic programmable overcurrent protection .....	p.	53

## EMI filters

Quick selection table .....	p.	54
TDV series 3-phase filter without neutral .....	p.	55
TDS series 3-phase filter without neutral .....	p.	56
TDDS series 3-phase filter without neutral .....	p.	57
TDSS series 3-phase filter without neutral .....	p.	58
TYT series 3-phase filter with neutral .....	p.	59
TY series compact 3-phase filter with neutral .....	p.	60
DK series single-cell single-phase filter .....	p.	61
DP series double-cell single-phase filter .....	p.	62

## Signal conditioners

Introduction .....	p.	63
Quick selection table .....	p.	65
Analogue signal converters .....	p.	67
Passive galvanic isolators .....	p.	73
Monitor module for analogue signal .....	p.	74
Universal temperature converters .....	p.	75
Monitor module for temperature sensor .....	p.	76
Programmable PT100 converters .....	p.	77
Programmable TC J and K converters .....	p.	78
Monitor module for current signal .....	p.	79
Current / analogue signal converters .....	p.	80
Frequency / analogue signal converters .....	p.	82
Auxiliary power supply for sensors and potentiometers .....	p.	83
NPN and PNP signal inverter .....	p.	84

## Electromechanical relay modules

Single relay quick selection table . . . . .	p. 85
R series relay modules . . . . .	p. 86
CM series relay modules . . . . .	p. 88
CKR series relay modules . . . . .	p. 93
CWRE series relay modules . . . . .	p. 95
Multiple relay quick selection table . . . . .	p. 96
Multiple relay module . . . . .	p. 97
Multiple relay module with test button . . . . .	p. 102
CR and CRE series super compact relays . . . . .	p. 103

## Solid state relay modules

Quick selection table . . . . .	p. 106
Single relays . . . . .	p. 107
CKS series super-compact single relays . . . . .	p. 110
Single relays with exchange output . . . . .	p. 112
Signal opto-isolators . . . . .	p. 113
Multiple relays . . . . .	p. 114

## Passive interface modules

Quick selection table . . . . .	p. 118
SUB-D / terminal block . . . . .	p. 119
FLAT-cable / terminal block . . . . .	p. 121
CCM series component holders . . . . .	p. 123
CDM series diode holders . . . . .	p. 124
CLT series LED testing module . . . . .	p. 126
CLP series lamp testing module . . . . .	p. 127

## Accessories

Electronic circuit housing . . . . .	p. 128
Bridges and markings . . . . .	p. 130
DIN rail clamp . . . . .	p. 132
Mounting rails . . . . .	p. 133

<b>Table of contents . . . . .</b>	<b>p. 135</b>
------------------------------------	---------------

# Cabur power house

Cabur continues to renew and expand its range of power supplies for use in industrial automation and control of processes and systems, improving product performance and technology to meet the needs created by the continuing changes in applications and regulations.

**QUALITY AND SAFETY:** Cabur was the first Italian company to obtain UL508 Industrial Control Equipment certification for industrial automation processes and Hazardous Location Class 1 Div. 2 for processes in dangerous areas, as well as to have been certified as conforming to the Directives on Electric Safety. It also has been EMC certified by an accredited laboratory. All of these are indispensable for the CE certified label.

## INNOVATION AND RESEARCH:

- 1997 - Cabur is the first Italian company to produce switching power supplies for DIN-rails with 90-264Vac/110-340Vdc universal input.
- 2001 - Cabur is the first Italian company to produce high efficiency power supplies with resonant technology (the 20A 3-phase dissipates only 36W compared to over 75W for our competitors at the time).
- 2009 – With the new generation of power supplies in the catalogue, Cabur has further improved performance using “Synchronous Rectifier” technology, which reduces power dissipation and operating temperature to the minimum, an indispensable factor in minimising the size of the power supplies, which are the smallest on the market.

The lifespan of a power supply is halved by every +10°C increase in operating temperature. Hence, reducing operating temperature is fundamental to endurance and reliability, two objectives that can be achieved only by using circuit technology and next generation components. Thanks to this combination, Cabur has achieved output of over 94% (the new 20A 3-phase dissipates only 28W, compared to the 50-75W in heat dissipation found in other products currently on the market).

**HIGH OVERLOAD CAPACITY:** the new power supplies have an overload capacity of over +50% for 5 seconds or for several minutes (please see the technical data), while maintaining stable output voltage even under these conditions.

**SYSTEM COMMUNICATIONS:** all the CSF, CSG, and CSW Series models are provided with “intelligent” alarm contacts that commute when the output voltage drops below -10% of the nominal value. This allows the controls to activate automated or emergency procedures to reduce machine stoppage, production losses, and the risk to safety.

**TOTAL PROTECTION:** all models are provided with output protection against overload short circuiting, overtemperature, and overvoltage, both for input and output. Input for the 3-phase models includes the Active Surge Suppressor – Inrush Current Limiter, which avoids malfunctioning in the case of overvoltage generated by commutation of loads or malfunctions on industrial networks, where the value can reach 3-4 times the network voltage, with a duration of 1.3ms (Regulation VDE-0160), which can be destructive for the input components. This increases reliability, especially in networks subject to power surges and power malfunctions.

**SHORT CIRCUIT AND OVERLOAD PROTECTION:** this serves to protect the power supply from malfunctions due to overloading and overheating of the components. This function can be designed by starting with different application needs, with varying practical results and costs. In automated applications, the operating conditions and the nature of the loads can vary greatly and are only partially known to the power supply designer. Power supplies for automated processes need to meet a number of requirements: they need to be protected from overcurrent, but at the same time they need to be able to supply loads which call for a high peak current, working at temperatures of at least 45° C, according to regulations, and sometimes higher, in critical ventilation situations and guaranteeing high reliability and acceptable costs. The overcurrent protection must support the high peak currents required by loads such as filament lamps (cold, they make a short circuit), capacitive loads such as dc/dc converters and filter condensators (when these switch on they are seen as a short-circuit for a few tenths of a ms) or inductive loads (engines in dc, electromagnets, etc.) which at peak require currents from 5 – 30 times their nominal power. Frequently, all these loads must be started up at the same time. The breakaway starting current must be provided for a sufficient duration to “start” the

load, which can go from a few tenths of a ms up to 5s.

With high-power power supplies, which power various loads protected from overcurrent, the capacity to provide overcurrent is indispensable to guarantee selectivity in protection interventions. This is because it allows the fuse of the malfunctioning load to be “burned” before the electronic protection of the power supply intervenes, disconnecting the output and hence the entire system.

## ELECTRONIC OVERLOAD POWER SUPPLY PROTECTION CAN BE OBTAINED USING VARIOUS TECHNIQUES:

- switch off the output as soon as possible: this is cost effective but doesn’t allow for either start up of heavy loads nor for protection selectivity for various loads.
- constant power protection: if the allowed overload is sufficiently high, it is possible to start up heavy loads. However, if the condition continues, the power supply will continue to operate in overload and with a high thermal stress level. Hiccup protection: combines the advantages of the techniques described above, while limiting the disadvantages because it allows over +50-100% of the overload for at least 5 seconds, and then switches off output for a longer break. In this way, the peak power necessary for heavy load peaks is obtained while component heating is decreased, as they can cool off during the break. Hiccup protection with high overcurrent output, for durations from 200 ms to over 5 sec., has been proven to satisfy the new requirements established by the Machinery Directive EN 60204-1.

**REAL OPERATING TEMPERATURE:** the operating temperature range for all Cabur models is between -20 and +50°C at full load without derating (see technical data), certified in accordance with the rigorous UL508 standard.

The project takes into consideration the ambient temperature, allowed overcurrent, and overcurrent duration when determining component size, and is always more than the 45°C required by the standards for electrical panels. Ambient temperature is a fundamental reference parameter, because this influences not only performance, but also component operating temperature and power supply duration.

**HOLD UP TIME:** this is the time in which the power supply output supplies nominal voltage at nominal load. This performance is important because it limits the cases in which machine/system stoppage can occur due to voltage “holes” in the network. EMC standards establish that Hold Up time must be at least 10ms. For all Cabur power supplies, Hold Up time is greater than that required by the official standards, which ensures better operational consistency in networks with frequent voltage holes.

**MTBF:** this figure should be taken with care, because it is the result of theoretical calculations that are easy to manipulate. For example, if we know that the mortality rate for 25 year old men is 0.1%/year, the resultant MTBF, calculated in accordance with SN29500 – IEC 61709, would be 800 years. Obviously, this result is highly unrealistic. The significant piece of information is the “life expectancy,” which for men averages about 75 years – less spectacular but more realistic. The same reasoning can be applied to electronic products for which, in accordance with the calculation methods, we can use an MTBF of 750,000 hours (85 years), or a life expectancy of about 70,000 hours (7.9 years, on average). The second estimate is less optimistic, but is without doubt closer to reality. As a consequence, data published regarding MTBF must be interpreted based on the credibility of the calculation methods used. In addition to the values according to SN 29500, Cabur has also chosen to declare those according to the MIL HDBKn217F standards, which are much stricter.

**CUSTOM POWER SUPPLIES:** Cabur designs and produces “custom” power supplies on request to meet the requirements of regulations and the high demanding applications. Furthermore our laboratory offers technical documentation and the measures which prove the conformity of the products with the directives on Electric Safety and Electromagnetic Compatibility, besides the necessary technical support to define the product characteristics on the basis of the client’s needs and our own experience.

## THE ENVIRONMENT AND ROHS CONFORMANCE:

Cabur was one of the first Italian companies to obtain the International Environmental Certificate UNI EN ISO 14001, certified by CSQ for ecologically compatible treatment of all the materials used in our production.

Since 2007, all Cabur products have been manufactured in conformity with the RoHS Wee directives.

## General notes

**PARALLEL AND REDUNDANT PARALLEL CONNECTION:** all Cabur power supplies can be connected in parallel to combine the power of two or more power supplies. In addition, models that already include an output separation diode (ORing diode) are available for use with redundant parallels (please see the related item in the catalogue).

We recommend adjusting the outputs of all the power supply units to the same voltage (tolerance  $\pm 50$  mV), applying the same calibration load, before connecting them in parallel. We also recommend using power supply units of the same model. If it is necessary to connect two power supplies without internal diodes in redundant parallel, the connection must be completed as in fig. 1.

**CONNECTION IN SERIES:** all Cabur power supplies can have their outputs connected in series to double the voltage (see fig. 2) or to obtain dual voltage output, for example with  $\pm 12$ V or  $\pm 24$  V (see fig. 3).

We recommend that you use power supplies of the same model and an anti-parallel diode, of an appropriate size to resist the maximum current of the power supply.

**POWER SIGNAL OK:** this is found on all CSF, CSG, and CWS models. The 1A / 30Vdc contact commutates when output voltage falls below the threshold of -10% of nominal voltage, in the case of a short circuit on the output line or an overload that exceeds the specifications, or due to network failure.

**100-340Vdc POWER SUPPLY:** available for certain models (please see technical data), which respect the following:

- power supply of 110...127 Vdc, reduces output current by 25%
- min. voltage allowed 100 Vdc, max 340 for single phase, 280...775 Vdc for single/2-phase, 564...775Vdc for 3-phase (please see technical data)
- respect input polarity as indicated in the instructions.

## Note for power supplies with secondary input from a transformer

**ISOLATION:** this series of power supply units is not insulated.

**TYPE OF USE:** they are suitable for use in PELV (Protective Extra Low Voltage, one pole grounded) and SELV (Safety Extra Low Voltage, no pole grounded).

The transformer used must have double or reinforced isolation in accordance with CEI 14.6 / EN 60742.

In the case of use in PELV circuits, only ground one pole of the 24 Vdc of the power supply unit. In the case of use in SELV circuits, do not ground the input grounding terminal.

**Grounding one pole of the secondary of the transformer and the 24Vdc of the power supply would damage the power supply.**

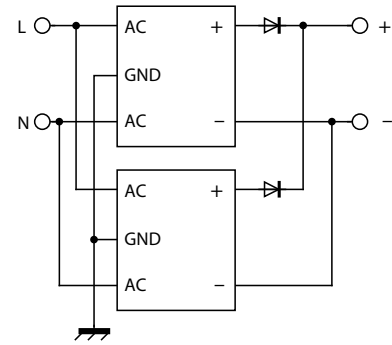

Figure 1

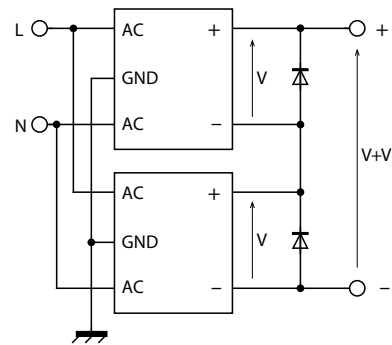

Figure 2

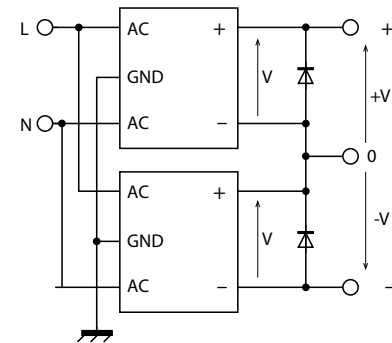

Figure 3

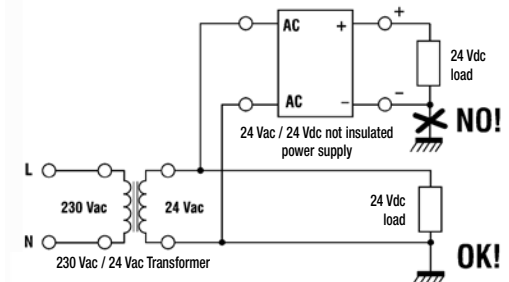

Figure 4

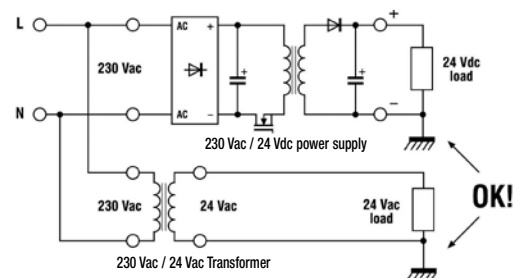

Figure 5



# Power supply quick selection table

These tables are used for quickly identifying items and verifying whether all of the product's technical details satisfy the set requirements.

## Single-phase switching power supply - Cool Power Series

Output voltage	Output current	Input voltage	Notes	Type	Cat. No.	Page
12...15 Vdc	6 A	90...264 Vac / 100...345 Vdc	(1) (7) (8) (9)	CSF85B	XCSF85B	17
24 Vdc	1.2 A	90...264 Vac / 100...320 Vdc	(1) (9)	CSF30C	XCSF30C	16
24 Vdc	3.5 A	90...264 Vac / 100...345 Vdc	(1) (7) (9)	CSF85C	XCSF85C	17
24 Vdc	3.5 A	90...264 Vac / 100...345 Vdc	(1) (6) (7) (9)	CSF85CP	XCSF85CP	17
24 Vdc	5 A	90...264 Vac / 100...345 Vdc	(1) (7) (9)	CSF120C	XCSF120C	18
24 Vdc	5 A	90...264 Vac / 100...345 Vdc	(1) (6) (7) (9)	CSF120CP	XCSF120CP	18
24 Vdc	10 A	120 Vac / 230 Vac	(2) (7)	CSF240C	XCSF240C	19
24 Vdc	10 A	120 Vac / 230 Vac	(2) (6) (7)	CSF240CP	XCSF240CP	19
24 Vdc	20 A	120 Vac / 230 Vac	(2) (6) (7)	CSF500C	XCSF500C	20
48 Vdc	2.5 A	90...264 Vac / 100...345 Vdc	(1) (6) (7)	CSF120DP	XCSF120DP	18
48 Vdc	5 A	120 Vac / 230 Vac	(2) (6) (7)	CSF240DP	XCSF240DP	19
48 Vdc	10 A	120 Vac / 230 Vac	(2) (6) (7)	CSF500D	XCSF500D	20

## Single-phase switching power supply - Easy Power Series

Output voltage	Output current	Input voltage	Notes	Type	Cat. No.	Page
24 Vdc	3.5 A	90...264 Vac	(1)	CSL85C	XCSL85C	23
24 Vdc	5 A	90...264 Vac	(1)	CSL120C	XCSL120C	24
24 Vdc	10 A	120 Vac / 230 Vac	(2)	CSL240C	XCSL240C	25
24 Vdc	20 A	230 Vac	-	CSL481C	XCSL481C	26

## Single-phase switching power supply - Domotic Power Series

Output voltage	Output current	Input voltage	Notes	Type	Cat. No.	Page
5...15 Vdc	3...1.5 A	90...264 Vac / 100...345 Vdc	(1) (8) (9)	CSD30E	XCSD30E	12
±12...±15	0.6 A	90...264 Vac / 100...345 Vdc	(1) (8) (9)	CSD30F	XCSD30F	12
12 Vdc	1.2 A	90...264 Vac / 100...315 Vdc	(1) (9)	CSD15B	XCSD15B	11
12...15 Vdc	3.5...3 A	90...264 Vac / 100...345 Vdc	(1) (8) (9)	CSD50B	XCSD50B	13
24 Vdc	0.6 A	90...264 Vac / 100...315 Vdc	(1) (9)	CSD15C	XCSD15C	11
24 Vdc	1.2 A	90...264 Vac / 100...345 Vdc	(1) (9)	CSD30C	XCSD30C	12
24 Vdc	3 A	90...264 Vac / 100...345 Vdc	(1) (9)	CSD70C	XCSD70C	14

## Single-phase, 2-phase, 3-phase switching power supply - Universal Power Series

Output voltage	Output current	Input voltage	Notes	Type	Cat. No.	Page
12...15 Vdc	8...7 A	1-2x 230-400-500 Vac	(1) (3) (7) (8) (9)	CSW121B	XCSW121B	28
12...15 Vdc	16...15 A	1-2-3x 230-400-500 Vac	(1) (3) (4) (7) (8) (9)	CSW241B	XCSW241B	29
24 Vdc	5 A	1-2x 230-400-500 Vac	(1) (3) (7) (9)	CSW121C	XCSW121C	28
24 Vdc	10 A	1-2-3x 230-400-500 Vac	(1) (3) (4) (7) (9)	CSW241C	XCSW241C	29
24 Vdc	20 A	1-2-3x 230-400-500 Vac	(1) (3) (4) (7) (9)	CSW481C	XCSW481C	30
24 Vdc	40 A	1-2x 230-400-500 Vac	(3) (6) (7)	CSW960CP	XCSW960CP	31
48 Vdc	5 A	1-2-3x 230-400-500 Vac	(1) (3) (4) (6) (7) (9)	CSW241DP	XCSW241DP	29
48 Vdc	10 A	1-2-3x 230-400-500 Vac	(1) (3) (4) (7) (9)	CSW481D	XCSW481D	30
72 Vdc	3.3 A	1-2-3x 230-400-500 Vac	(1) (3) (4) (6) (7) (8) (9)	CSW241G	XCSW241G	29
72 Vdc	6 A	1-2-3x 230-400-500 Vac	(1) (3) (4) (7) (8) (9)	CSW481G	XCSW481G	30

# Power supply quick selection table

These tables are used for quickly identifying items and verifying whether all of the product's technical details satisfy the set requirements.

## 3-phase switching power supply - Triple Power Series

Output voltage	Output current	Input voltage	Notes	Type	Cat. No.	Page
24 Vdc	20 A	3x 400-500 Vac	(4) (7)	CSG481C	XCSG481C	33
24 Vdc	20 A	3x 400-500 Vac	(4) (7)	CSG500C	XCSG500C	34
24 Vdc	30 A	3x 400-500 Vac	(4) (7)	CSG720C	XCSG720C	35
24 Vdc	40 A	3x 400-500 Vac	(4) (7)	CSG960C	XCSG960C	36
24 Vdc	100 A	3x 400-500 Vac	(4) (6) (7) (8)	CSG2401C	XCSG2401C	37
48 Vdc	15 A	3x 400-500 Vac	(4) (6) (7)	CSG720D	XCSG720D	35
48 Vdc	20 A	3x 400-500 Vac	(4) (6) (7)	CSG960D	XCSG960D	36
48 Vdc	50 A	3x 400-500 Vac	(4) (6) (7) (8)	CSG2401D	XCSG2401D	37
72 Vdc	6.7 A	3x 400-500 Vac	(4) (6) (7) (8)	CSG500G	XCSG500G	34
72 Vdc	13.3 A	3x 400-500 Vac	(4) (6) (7) (8)	CSG960G	XCSG960G	36
72 Vdc	33 A	3x 400-500 Vac	(4) (6) (7) (8)	CSG2401G	XCSG2401G	38
170 Vdc	14 A	3x 400-500 Vac	(4) (6) (7) (8)	CSG2401R	XCSG2401R	38

## Switching power supplies in IP65 case

Output voltage	Output current	Input type	Input voltage	Notes	Type	Cat. No.	Page
24 Vdc	5 A	Single phase	90...264 Vac / 100...345 Vdc	(1) (7) (9)	CSF565	XCSF565	21

## Power supply with input from a transformer

Output voltage	Output current	Input type	Input voltage	Notes	Type	Cat. No.	Page
1.2...24 Vdc	1.5 A	From transformer	9...26 Vac	(5) (8)	CL1R	XCL1R	41
1.2...24 Vdc	5 A	From transformer	9...26 Vac	(5) (8)	CL5R	XCL5R	41

## Filtered power supply with not stabilised output

Output voltage	Output current	Input type	Input voltage	Notes	Type	Cat. No.	Page
12...24 Vdc	6 A	From transformer	9...20 Vac	(5)	AR6	XAR6	42

## DC/DC isolated converters

Input voltage	Output voltage	Output current	Notes	Type	Cat. No.	Page
12 Vdc	24 Vdc	5 A	(9)	CSA120BC	XCSA120BC	39
24 Vdc	12...15 Vdc	7 A	(8) (9)	CSA120CB	XCSA120CB	39
24 Vdc	24 Vdc	5 A	(9)	CSA120CC	XCSA120CC	39
48 Vdc	24 Vdc	5 A	(9)	CSA120DC	XCSA120DC	39
110 Vdc	24 Vdc	10 A	(6) (7) (9)	CSA240FC	XCSA240FC	40

(All wide range single-phase power supplies may be powered at 110 Vdc)

### Notes

- (1) wide range single-phase input
- (2) double range single-phase input
- (3) 2-phase input
- (4) 3-phase input

- (5) secondary input from a transformer
- (6) redundant version
- (7) with failure contact
- (8) with adjustable output
- (9) DC/DC converter

# Modular switching power supply - CSD Series

## DOMOTIC POWER

**Single-phase switching power supply with power up to 70W** for use in civil and industrial automation applications. The technical and design characteristics of the housing, with standard modular DIN measurements for installation in control units **were planned to optimise use in home automation**. The performance level and **compact size** also make it an excellent solution for electrical panels and shallow containers. High output and a contained working temperature support energy savings and longer component life.

### Suggested uses

- Industrial automation applications
- Civil automation applications
- General applications in systems installed using small remote panels

### Main features

- The 90...264 Vac and 110...370 Vdc inputs, make it suitable for use on all power supply networks.
- These are Isolation Class 2 power supplies that do not require a grounding connection, which reduces the times and costs of installation in remote panels and surveillance and monitoring systems.
- Their high efficiency reduces energy consumption and operating temperature and allows for use in small housings.
- The large power reserve allows continuous current to be supplied up to at least +50% higher than the rated value, ensuring safety and reliability.
- Short-circuit and overload protection designed to deliver peak currents more than 150% higher than the rated value required by heavy loads.
- Thermal protection prevents failure in cases of prolonged overload at high ambient temperatures.
- Thanks to the high performance and excellent ventilation of internal the components, they are greatly reduced in size and have a degree of protection from accidental contacts of IP20 per IEC529.



### Compact size

Ideal for modular control units and shallow containers

### Short-circuit and overload protection

Designed to deliver the typical peak currents required by medium loads

### High efficiency

Designed to save energy and reduce operating temperature

### Power boost

The output power supplied reaches up to 130% of the rated value.

### Input 90...264 Vac and 110...370 Vdc

Appropriate for use on all power supply networks



# Single-phase switching power supply 120-230 Vac - output power 15 W

- Single-phase input 90...264 Vac and DC 100...315 Vdc
- Short circuit, overload, over temperature, input overvoltage protection
- Isolation Class 2, does not require grounding connection
- Compact dimensions
- Suitable for SELV and PELV circuits

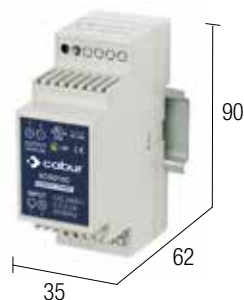

## NOTES

The depth measurement includes rail clamp clearance.

- (2) Over 45°C apply the following derating:  
version C: -0.015 A/°C; version B: -0.03 A/°C.
- (3) The current deliverable by the power supply also depends on the line resistance

## BLOCK DIAGRAM

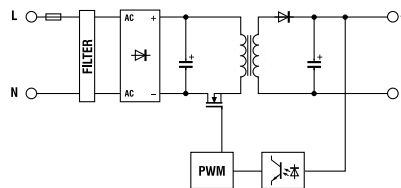

## VERSIONS

- Output 24 Vdc 0.6 A
- Output 24 Vdc 0.6 A redundant version
- Output 12 Vdc 1.2 A
- Output 48 Vdc 0.3 A

## INPUT TECHNICAL DATA

Input rated voltage	120-230 Vac (range 90...264 Vac / 100...315 Vdc)
Frequency	47...63 Hz
Current with nominal Iout (Uin 120 / 230 Vac)	0.3 A / 0.16 A ± 10%
Inrush peak current	< 5 A
Power factor	> 0.6
Internal protection fuse	T 1 A replaceable
External protection on AC line	circuit breaker 2 A characteristic C - fuse: T 2 A

## OUTPUT TECHNICAL DATA

Output rated voltage	24 Vdc ± 1%
Output adjustable range	—
Continuous current	0.6 A at 50°C (2)
Overload limiting current	1.08 A (3)
Short circuit peak current	—
Load regulation	< 1%
Ripple at nominal ratings	≤ 30 mVpp
Hold up time (Uin 120 / 230 Vac)	>12 ms / >20 ms
Overload / short circuit protections	hiccup at the overload limit with auto reset/thermal protection
Status display	Green LED "DC OK"
Alarm contact threshold	—
Parallel connection	possible
Redundant parallel connection	possible with external ORing diode

Code XCSD15C	Code XCSD15B
CSD15C	CSD15B
120-230 Vac (range 90...264 Vac / 100...315 Vdc)	
47...63 Hz	
0.3 A / 0.16 A ± 10%	
< 5 A	
> 0.6	
T 1 A replaceable	
circuit breaker 2 A characteristic C - fuse: T 2 A	
<b>24 Vdc ± 1%</b>	<b>12 Vdc ± 0.5 Vdc</b>
—	—
<b>0.6 A at 50°C (2)</b>	<b>1.2 A at 50°C (2)</b>
1.08 A (3)	2.16 A (3)
—	—
< 1%	< 1%
≤ 30 mVpp	≤ 30 mVpp
>12 ms / >20 ms	>12 ms / >20 ms
hiccup at the overload limit with auto reset/thermal protection	
Green LED "DC OK"	
—	—
possible	possible
possible with external ORing diode	possible with external ORing diode
>85% / >87%	
2.5 W / 2.2 W	
-20...+60°C, with derating above 45°C/thermal protection (2)	
3 kVac / 60 s SELV output	
class 2 without PE connection	
class 2 without PE connection	
EN 60950-1+A1+A2+A12, UL 508	
EN61000-6-2, EN61000-6-4	
>750'000 h according to SN 29500 / >250'000 h according to MIL Std. HDBK 217F	
II / 2	
IP 20 IEC 529, EN60529	
2.5 mm <sup>2</sup> screw-clamp terminal blocks	
UL94V-0 plastic	
130 g	
vertical on rail, allow 10 mm spacing between adjacent components	
<b>PR/3/AC, PR/3/AC/ZB, PR/3/AS, PR/3/AS/ZB</b>	

## GENERAL TECHNICAL DATA

Efficiency (Uin 120 / 230 Vac)	>85% / >87%
Dissipated power (Uin 120 / 230 Vac)	2.5 W / 2.2 W
Operating temperature range	-20...+60°C, with derating above 45°C/thermal protection (2)
Input/output isolation	3 kVac / 60 s SELV output
Input/PE isolation	class 2 without PE connection
Output/PE isolation	class 2 without PE connection
Safety standards	EN 60950-1+A1+A2+A12, UL 508
Electromagnetic compatibility	EN61000-6-2, EN61000-6-4
MTBF at 25°C and nominal ratings	>750'000 h according to SN 29500 / >250'000 h according to MIL Std. HDBK 217F
Overvoltage category / Pollution degree	II / 2
Protection degree	IP 20 IEC 529, EN60529
Connection type	2.5 mm <sup>2</sup> screw-clamp terminal blocks
Housing material	UL94V-0 plastic
Approximate Weight	130 g
Mounting information	vertical on rail, allow 10 mm spacing between adjacent components

## MOUNTING ACCESSORIES

- Mounting rail type according to IEC60715/TH35-7.5
- Mounting rail type according to IEC60715/G32

# Single-phase switching power supply 120-230 Vac - output power 30 W

- Single-phase input 90...264 Vac and DC 100...345 Vdc
- Short circuit, overload, over temperature, input overvoltage protection
- Isolation Class 2, does not require grounding connection
- Compact dimensions
- Suitable for SELV and PELV circuits



## NOTES

- The depth measurement includes rail clamp clearance.
- (2) Over 45°C apply the following derating:  
versions C and F: -0.03 A/°C; version E: -0.08...-0.04 A/°C.
  - (3) The current deliverable by the power supply also depends on the line resistance.
  - (4) The current depends on the adjusted output voltage: 3.3A at 5Vdc, 2A at 9Vdc, 2.2A at 12Vdc, 1.5A at 15Vdc.

## BLOCK DIAGRAM

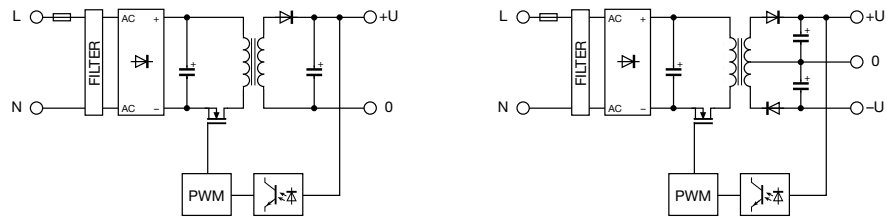

## VERSIONS

- Output 24 Vdc 1.2 A
- Output 24 Vdc 1.2 A redundant version
- Output 5...15 Vdc 3.3...1.5 A
- Output ±12...±15 Vdc 0.6 A

## INPUT TECHNICAL DATA

Input rated voltage	120 / 230 Vac
Frequency	47...63 Hz
Current with nominal Iout (Uin 120 / 230 Vac)	0.55 A / 0.28 A ± 10%
Inrush peak current	< 13 A
Power factor	> 0.6
Internal protection fuse	Replaceable T 2 A
External protection on AC line	circuit breaker 3 A characteristic C - fuse: T 3.15 A

## OUTPUT TECHNICAL DATA

Output rated voltage	24 Vdc ± 1%
Output adjustable range	5...15 Vdc
Continuous current	1.2 A at 50°C (2)
Overload limiting current	1.6 (3)
Short circuit peak current	4 A (3)
Load regulation	< 1%
Ripple at nominal ratings	≤ 50 mVpp
Hold up time (Uin 120 / 230 Vac)	>30 ms / >60 ms
Overload / short circuit protections	>50 ms / >100 ms
Status display	hiccup at the overload limit with auto reset/thermal protection Green LED "DC OK"
Alarm contact threshold	-
Parallel connection	possible
Redundant parallel connection	possible with external ORing diode

## GENERAL TECHNICAL DATA

Efficiency (Uin 120 / 230 Vac)	>85% / >87%
Dissipated power (Uin 120 / 230 Vac)	5.1 W / 4.3 W
Operating temperature range	-20...+60°C, with derating above 45°C/thermal protection (2)
Input/output isolation	3 kVac / 60 s SELV output
Input/PE isolation	class 2 without PE connection
Output/PE isolation	class 2 without PE connection
Safety standards	EN 60950-1+A1+A2+A12, UL 508
Electromagnetic compatibility	EN61000-6-1, EN61000-6-2, EN61000-6-3, EN61000-6-4
MTBF at 25°C and nominal ratings	>750'000 h according to SN 29500 / >250'000 h according to MIL Std. HDBK 217F
Overvoltage category / Pollution degree	II / 2
Protection degree	IP 20 IEC 529, EN60529
Connection type	2.5 mm² fixed screw terminal blocks
Housing material	UL94V-0 plastic
Approximate weight	200 g
Mounting information	vertical on rail, allow 10 mm spacing between adjacent components

## MOUNTING ACCESSORIES

- Mounting rail type according to IEC60715/TH35-7.5
- Mounting rail type according to IEC60715/G32

Code XCSD30C	Code XCSD30E	Code XCSD30F
CSD30C	-	-
-	CSD30E	-
-	-	CSD30F

120-230 Vac (range 90...264 Vac / 100...345 Vdc)		
47...63 Hz		
0.55 A / 0.28 A ± 10%	0.45 A / 0.25 A ± 10%	0.4 A / 0.2 A ± 10%
< 13 A	< 13 A	< 13 A
> 0.6		
Replaceable T 2 A		
circuit breaker 3 A characteristic C - fuse: T 3.15 A		

24 Vdc ± 1%	5...15 Vdc	±12...±15 Vdc
5...15 Vdc	5...15 Vdc	±12...±15 Vdc
1.2 A at 50°C (2)	3.3...1.5 A at 50°C (2)(4)	2x0.6 A at 50°C (2)
1.6 (3)	4 A (3)	>2x0.8 A (3)
-	-	-
< 1%	< 1%	< 1%
≤ 50 mVpp	≤ 50 mVpp	≤ 50 mVpp
>30 ms / >60 ms	>50 ms / >100 ms	>50 ms / >100 ms
hiccup at the overload limit with auto reset/thermal protection		
Green LED "DC OK"		
-	-	-
possible	possible	possible
possible with external ORing diode	possible with external ORing diode	possible with external ORing diode

>85% / >87%	>87% / >89%	>87% / >89%
5.1 W / 4.3 W	4.0 W / 3.4 W	1.6 W / 1.3 W
-20...+60°C, with derating above 45°C/thermal protection (2)		
3 kVac / 60 s SELV output		
class 2 without PE connection		
class 2 without PE connection		
EN 60950-1+A1+A2+A12, UL 508		
EN61000-6-1, EN61000-6-2, EN61000-6-3, EN61000-6-4		
>750'000 h according to SN 29500 / >250'000 h according to MIL Std. HDBK 217F		
II / 2		
IP 20 IEC 529, EN60529		
2.5 mm² fixed screw terminal blocks		
UL94V-0 plastic		
200 g		
vertical on rail, allow 10 mm spacing between adjacent components		

PR/3/AC, PR/3/AC/ZB, PR/3/AS, PR/3/AS/ZB

# Single-phase switching power supply 120-230 Vac - output power 50 W

- Single-phase input 90...264 Vac and DC 100...345 Vdc
- Short circuit, overload, over temperature, input overvoltage protection
- Isolation Class 2, does not require grounding connection
- Compact dimensions
- Suitable for SELV and PELV circuits

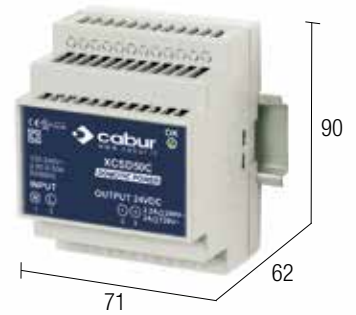

## NOTES

- The depth measurement includes rail clamp clearance.
- (2) With an input powered at 100...127 Vdc, using constant power and  $T_a > 45^\circ\text{C}$ , the outrush current is reduced by 25%
  - (3) Over  $45^\circ\text{C}$  apply the following derating:  
version C:  $-0.06\text{ A}/^\circ\text{C}$ ; version B:  $-0.085\text{ A}/^\circ\text{C}$ .
  - (4) The value of the current supplied by the power supply also depends on the line resistance.

## BLOCK DIAGRAM

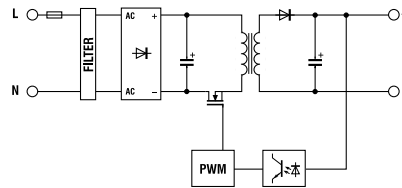

## VERSIONS

- Output 24 Vdc 2.2 A
- Output 24 Vdc 2.2 A redundant version
- Output 12...15 Vdc 3.5...3 A
- Output 48 Vdc 1.1 A

## Code XCS50B

-		
	<b>CSD50B</b>	-

## INPUT TECHNICAL DATA

Input rated voltage
Frequency
Current with nominal Iout (Uin 120 / 230 Vac)
Inrush peak current
Power factor
Internal protection fuse
External protection on AC line

<b>120-230 Vac</b> (range 90...264 Vac / 100...345 Vdc) (2)
47...63 Hz
0.9 A / 0.5 A $\pm$ 10%
< 15 A
> 0.6
Replaceable T 2 A
circuit breaker 3 A characteristic C - fuse: T 3.15 A

## OUTPUT TECHNICAL DATA

Output rated voltage
Output adjustable range
Continuous current
Overload limiting current
Short circuit peak current
Load regulation
Ripple at nominal ratings
Hold up time (Uin 120 / 230 Vac)
Overload / short circuit protections
Status display
Alarm contact threshold
Parallel connection
Redundant parallel connection

<b>12...15 Vdc</b>
12...15 Vdc
<b>3.5...3 A</b> at $50^\circ\text{C}$ (3)
4.37...3.75 A (4)
-
< 1%
$\leq 50\text{ mVpp}$
>20 ms / >40 ms
hiccup at the overload limit with auto reset/thermal protection
Green LED "DC OK"
-
possible
possible with external ORing diode

## GENERAL TECHNICAL DATA

Efficiency (Uin 120 / 230 Vac)
Dissipated power (Uin 120 / 230 Vac)
Operating temperature range
Input/output isolation
Input/PE isolation
Output/PE isolation
Safety standards
Electromagnetic compatibility
MTBF at $25^\circ\text{C}$ and nominal ratings
Overvoltage category / Pollution degree
Protection degree
Connection type
Housing material
Approximate weight
Mounting information

>85% / >88%
7.9 W / 6.1 W
$-20\text{...}+60^\circ\text{C}$ , with derating over $45^\circ\text{C}$ / thermal protection (3)
3 kVac / 60 s SELV output
class 2 without PE connection
class 2 without PE connection
EN 60950-1+A1+A2+A12, UL 508
EN61000-6-1, EN61000-6-2, EN61000-6-3, EN61000-6-4
>750'000 h according to SN 29500 / >250'000 h according to MIL Std. HDBK 217F
II / 2
IP 20 IEC 529, EN60529
2.5 mm <sup>2</sup> fixed screw terminal blocks
UL94V-0 plastic
200 g
vertical on rail, allow 10 mm spacing between adjacent components

## MOUNTING ACCESSORIES

- Mounting rail type according to IEC60715/TH35-7.5
- Mounting rail type according to IEC60715/G32

**PR/3/AC, PR/3/AC/ZB, PR/3/AS, PR/3/AS/ZB**



# Single-phase switching power supply 120-230 Vac - output power 70 W

- Single-phase input 90...264 Vac and DC 100...345 Vdc
- Short circuit, overload, over temperature, input overvoltage protection
- Isolation Class 2, does not require grounding connection
- Compact dimensions
- Suitable for SELV and PELV circuits

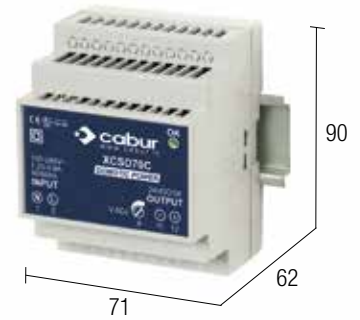

## NOTES

- The depth measurement includes rail clamp clearance.
- (2) With an input powered at 100...127 Vdc, using constant power and  $T_a > 45^\circ\text{C}$ , the outrush current is reduced by 25%
  - (3) Over  $55^\circ\text{C}$  apply the following derating: version C:  $-0.15 \text{ A}/^\circ\text{C}$ .
  - (4) The value of the current supplied by the power supply also depends on the line resistance.

## BLOCK DIAGRAM

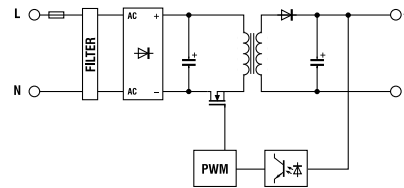

## VERSIONS

- Output 24 Vdc 3 A
- Output 24 Vdc 3 A redundant version
- Output 12...15 Vdc 5...4 A
- Output 48 Vdc 1.5 A

## Code XCSD70C

Code XCSD70C			
CSD70C	-	-	-

## INPUT TECHNICAL DATA

Input rated voltage	120-230 Vac (range 90...264 Vac / 100...345 Vdc) (2)
Frequency	47...63 Hz
Current with nominal Iout (Uin 120 / 230 Vac)	1.25 A / 0.8 A $\pm 10\%$
Inrush peak current	< 15 A
Power factor	> 0.6
Internal protection fuse	T 2 A non-replaceable
External protection on AC line	circuit breaker 4 A characteristic C - fuse: T 3.15 A

## OUTPUT TECHNICAL DATA

Output rated voltage	24 Vdc
Output adjustable range	24...27.5 Vdc
Continuous current	3 A at $55^\circ\text{C}$ (3)
Overload limiting current	4 A (4)
Short circuit peak current	—
Load regulation	< 1%
Ripple at nominal ratings	$\leq 60 \text{ mVpp}$
Hold up time (Uin 120 / 230 Vac)	>15 ms / >30 ms
Overload / short circuit protections	hiccup at the overload limit with auto reset
Status display	Green LED "DC OK"
Alarm contact threshold	—
Parallel connection	possible
Redundant parallel connection	possible with external ORing diode

## GENERAL TECHNICAL DATA

Efficiency (Uin 120 / 230 Vac)	>87% / >89%
Dissipated power (Uin 120 / 230 Vac)	10.8 W / 8.9 W
Operating temperature range	$-20...+60^\circ\text{C}$ , with derating above $55^\circ\text{C}$ (3)
Input/output isolation	3 kVac / 60 s SELV output
Input/PE isolation	class 2 without PE connection
Output/PE isolation	class 2 without PE connection
Safety standards	EN 60950-1+A1+A2+A12, UL 508
Electromagnetic compatibility	EN61000-6-1, EN61000-6-2, EN61000-6-3, EN61000-6-4
MTBF at $25^\circ\text{C}$ and nominal ratings	>750'000 h according to SN 29500 / >250'000 h according to MIL Std. HDBK 217F
Overvoltage category / Pollution degree	II / 2
Protection degree	IP 20 IEC 529, EN60529
Connection type	2.5 mm <sup>2</sup> fixed screw terminal blocks
Housing material	UL94V-0 plastic
Approximate weight	250 g
Mounting information	vertical on rail, allow 10 mm spacing between adjacent components

## MOUNTING ACCESSORIES

Mounting rail type according to IEC60715/TH35-7.5	PR/3/AC, PR/3/AC/ZB, PR/3/AS, PR/3/AS/ZB
Mounting rail type according to IEC60715/G32	—

# Switching power supplies - CSF Series

## COOL POWER

**Single-phase switching power supply with DIN-rail**, designed specifically for applications in command and control panels for industrial automation and process control. Capable of delivering +60% to +80% nominal current for a prolonged period of time while maintaining a constant output voltage and equipped with a voltage threshold-controlled failure contact which is triggered when the voltage drops below 90% of the rated value. **With these features and numerous international certifications, this range of power supplies enables designers to meet the requirements of the Machinery Directive EN 60204-1**, allowing the protection devices connected to the output to trigger quickly, safely and selectively, thus ensuring continuity of service to the other parts of the system.

### Suggested uses

- Applications in industrial automation with high performance and reliability requirements.
- Applications which require selectable overcurrent protections on DC lines
- Applications in machine automation with high command and control voltage reliability and safety requirements
- Applications in process control
- Uses with heavy loads
- Civil automation applications

### Main features

- The 90...264 Vac and 110...370 Vdc inputs, make it suitable for use on all power supply networks.
- Threshold failure contact which is triggered when the voltage falls below 90% of the rated value.
- Versions with integrated ORing diode for redundant parallel connection, preventing the need for external devices and reducing bulk and installation costs.
- High efficiency reduces energy consumption and the operating temperature of components and allows use in small panels and severe environmental conditions.
- Large power reserve allows for delivery of at least +60-80% nominal current and voltage for several minutes, ensuring safety and reliability.
- Output voltage is adjustable and the output is protected against input surge from the DC line generated from inductive loads.
- The output is equipped with dual electronic protection which prevents dangerous voltages for powered components in the event of an internal fault.
- Thermal protection prevents faults in case of prolonged overload with high ambient temperatures.
- Construction ensures excellent ventilation capacity of internal components, with reduced sizes and a degree of protection from accidental contacts of IP20 per IEC529.
- Thanks to their high performance and excellent ventilation capacity, they are among the smallest on the market.

### Extremely compact dimensions

Among the smallest on the market, optimising the use of space in the panel without compromising performance

### Short-circuit and overload protection

Designed to deliver the strong peak currents required by heavy loads

### Power boost

The output power reaches 120% of the nominal value for several minutes, up to 160% in the event of overload, and up to 300% during a short-circuit, to enable the protection devices connected to the output to trigger quickly, safely and selectively, without the use of additional modules.

### High efficiency

Designed to save energy and reduce operating temperature

### Input 90...264 Vac and 110...370 Vdc

Appropriate for use on all single-phase power supply networks

### Intelligent failure contact

Notifies when the output voltage falls below 90% of the rated value once a threshold is surpassed

### Special power supplies for engines DC, Brushless, and relative drives

New 48Vdc and 72-85Vdc models have been introduced, designed to reliably power engines in DC. They:

- supply peak power equal to even 4-5 times the nominal current, which is required by the engine during the peak phase
- have an output stage protected from overvoltage generated by the engines and drives during braking, which could otherwise cause malfunctions or cause the power supply to lose control over output voltage stability
- Provide output voltage at 48Vdc, and 72...85Vdc. By increasing the voltage of the engine power supply, the same power can be obtained at lower current, with notable advantages for performance, engine construction, connection wires, and drives.





# Single-phase switching power supply 120-230 Vac - output power 30 W

- Single-phase input 90...264 Vac and DC 100...320 Vdc
- Short circuit, overload and overvoltage protection
- Isolation Class 2, does not require grounding connection
- Compact dimensions
- Suitable for SELV and PELV circuits



## NOTES

- The depth measurement includes rail clamp clearance.
- (1) Version made to order (not kept in stock); contact our sales office for availability.
  - (2) With an input powered at 100...127 Vdc, using constant power and  $T_a > 45^\circ\text{C}$ , the outrush current is reduced by 25%
  - (3) Over  $50^\circ\text{C}$  apply the following derating: version C:  $-0.03\text{ A}/^\circ\text{C}$ ; version B:  $-0.038\text{ A}/^\circ\text{C}$ ; version F:  $-0.013\text{ A}/^\circ\text{C}$
  - (4) The value of the current supplied by the power supply also depends on the line resistance.

## BLOCK DIAGRAM

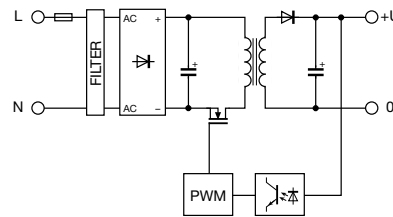

## VERSIONS

Output 24 Vdc 1.2 A

Code XCSF30C	
CSF30C (1)	-

## INPUT TECHNICAL DATA

Input rated voltage	120-230 Vac (range 90...264 Vac / 100...320 Vdc) (2)
Frequency	47...63 Hz
Current with nominal Iout (Uin 120 / 230 Vac)	0.55 A / 0.3 A ± 10%
Inrush peak current	0.35 A / 0.2 A ± 10%
Power factor	< 25 A
Internal protection fuse	> 0.60
External protection on AC line	Non-replaceable T 1.25 A circuit breaker 2 A characteristic C - fuse: T 2 A

## OUTPUT TECHNICAL DATA

Output rated voltage	24 Vdc ± 1%
Output adjustable range	—
Continuous current	1.2 A at 50°C (3)
Overload limiting current	1.4 A (4)
Short circuit peak current	—
Load regulation	< 1%
Ripple at nominal ratings	≤ 50 mVpp
Hold up time (Uin 120 / 230 Vac)	>10 ms / >30 ms
Overload / short circuit protections	hiccup at the overload limit with auto reset
Status display	Green LED "DC OK"
Alarm contact threshold	—
Parallel connection	possible
Redundant parallel connection	possible with external ORing diode

## GENERAL TECHNICAL DATA

Efficiency (Uin 120 / 230 Vac)	>86% / >87%
Dissipated power (Uin 120 / 230 Vac)	4.7 W / 4.3 W
Operating temperature range	-20...+60°C, with derating over 50°C (3)
Input/output isolation	3 kVac / 60 s SELV output
Input/PE isolation	class 2 without PE connection
Output/PE isolation	class 2 without PE connection
Safety standards	EN 60950-1+A1+A2+A12, UL 508
Electromagnetic compatibility	EN61000-6-2, EN61000-6-4
MTBF at 25°C and nominal ratings	>750'000 h according to SN 29500 / >250'000 h according to MIL Std. HDBK 217F
Overvoltage category / Pollution degree	II / 2
Protection degree	IP 20 IEC 529, EN60529
Connection type	2.5 mm² fixed screw terminal blocks
Housing material	UL94V-0 plastic
Approximate weight	140 g
Mounting information	vertical on rail, allow 10 mm spacing between adjacent components

## MOUNTING ACCESSORIES

- Mounting rail type according to IEC60715/TH35-7.5
- Mounting rail type according to IEC60715/G32

PR/3/AC, PR/3/AC/ZB, PR/3/AS, PR/3/AS/ZB	—
--	---

# Single-phase switching power supply 120-230 Vac - output power 85 W

- Single-phase input 90...264 Vac and DC 100...345 Vdc
- Short circuit, overload, over temperature and overvoltage input and output protection
- Elevated outrush current to ensure the selectivity of protections and start-up of heavy loads
- Failure contact with threshold Uout -10%
- Compact dimensions
- Suitable for SELV and PELV circuits

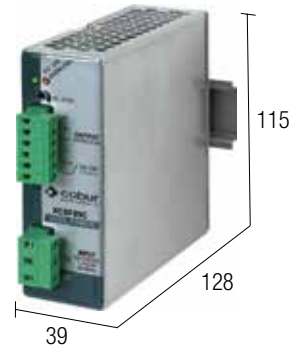

## NOTES

- The depth measurement includes rail clamp clearance.
- (2) With an input powered at 100...127 Vdc, using constant power and  $T_a > 45^\circ\text{C}$ , the outrush current is reduced by 25%
  - (3) Over  $45^\circ\text{C}$  apply the following derating:  $-0.06\text{ A}/^\circ\text{C}$  for version C, CP and CPH;  $-0.10\text{ A}/^\circ\text{C}$  for version B
  - (4) For this peak of power, the output voltage does not decrease more than 10% of the rated value, however the value of the current supplied by the power supply also depends on the line resistance.

## BLOCK DIAGRAM

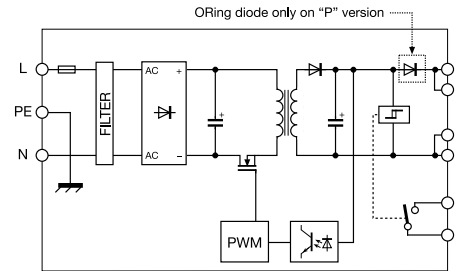

## VERSIONS

- Output 24 Vdc 3.5 A
- Output 24 Vdc 3.5 A redundant version
- Output 12...15 Vdc 6 A
- Output 48 Vdc 1.8 A

Code XCSF85C	Code XCSF85CP	Code XCSF85B
CSF85C		
	CSF85CP	
		CSF85B
		-

## INPUT TECHNICAL DATA

Input rated voltage	120-230 Vac (range 90...264 Vac / 100...345 Vdc) (2)
Frequency	47...63 Hz
Current with nominal Iout (Uin 120 / 230 Vac)	1.6 A / 0.9 A $\pm$ 10%
Inrush peak current	< 20 A
Power factor	> 0.65
Internal protection fuse	Replaceable T 2 A
External protection on AC line	circuit breaker 4 A characteristic C - fuses: T 4 A

<b>120-230 Vac</b> (range 90...264 Vac / 100...345 Vdc) (2)	
47...63 Hz	
1.6 A / 0.9 A $\pm$ 10%	
< 20 A	
> 0.65	
Replaceable T 2 A	
circuit breaker 4 A characteristic C - fuses: T 4 A	

## OUTPUT TECHNICAL DATA

Output rated voltage	<b>24 Vdc</b>	<b>12...15 Vdc</b>	
Output adjustable range	23...27.5 Vdc	12...15 Vdc	
Continuous current	<b>3.5 A</b> at 50°C (3)	<b>6 A</b> at 50°C (3)	
Overload limiting current	6 A for >30 s with Uout >90% Un (4)	9 A for >30 s with Uout >90% Un (4)	
Short circuit peak current	10 A for 50 ms (4)	10 A for 50 ms (4)	
Load regulation	< 1%	< 1%	
Ripple at nominal ratings	$\leq 70\text{ mVpp}$	$\leq 30\text{ mVpp}$	
Hold up time (Uin 120 / 230 Vac)	>20 ms / >70 ms	>15 ms / >60 ms	
Overload / short circuit protections	hiccup at the overload limit with auto reset/thermal protection		
Status display	Green LED "DC OK" / failure contact "DC OK" / Red LED "Overload"		
Alarm contact threshold	21.6 Vdc	10.8 Vdc	
Parallel connection	possible	possible	
Redundant parallel connection	possible with external ORing diode	already fitted with internal ORing diode	possible with external ORing diode

<b>24 Vdc</b>	<b>12...15 Vdc</b>	
23...27.5 Vdc	12...15 Vdc	
<b>3.5 A</b> at 50°C (3)	<b>6 A</b> at 50°C (3)	
6 A for >30 s with Uout >90% Un (4)	9 A for >30 s with Uout >90% Un (4)	
10 A for 50 ms (4)	10 A for 50 ms (4)	
< 1%	< 1%	
$\leq 70\text{ mVpp}$	$\leq 30\text{ mVpp}$	
>20 ms / >70 ms	>15 ms / >60 ms	
hiccup at the overload limit with auto reset/thermal protection		
Green LED "DC OK" / failure contact "DC OK" / Red LED "Overload"		
21.6 Vdc	10.8 Vdc	
possible	possible	
possible with external ORing diode	already fitted with internal ORing diode	possible with external ORing diode

## GENERAL TECHNICAL DATA

Efficiency (Uin 120 / 230 Vac)	>86% / >90%	>83% / >87%
Dissipated power (Uin 120 / 230 Vac)	14 W / 10 W	17 W / 13 W
Operating temperature range	-20...+60°C, with derating over 45°C / thermal protection (3)	
Input/output isolation	3 kVac / 60 s SELV output	
Input/PE isolation	1.5 kVac / 60 s	
Output/PE isolation	0.5 kVac / 60 s	
Safety standards	EN 60950-1+A1+A2+A12, UL 508	
Electromagnetic compatibility	EN61000-6-1, EN61000-6-2, EN61000-6-3, EN61000-6-4	
MTBF at 25°C and nominal ratings	>500'000 h according to SN 29500 / >150'000 h according to MIL Std. HDBK 217F	
Overvoltage category / Pollution degree	II / 2	
Protection degree	IP 20 IEC 529, EN60529	
Connection type	2.5 mm <sup>2</sup> removable screw terminal blocks	
Housing material	aluminium	
Approximate weight	400 g	
Mounting information	vertical on rail, allow 10 mm spacing between adjacent components	

>86% / >90%	>83% / >87%
14 W / 10 W	17 W / 13 W
-20...+60°C, with derating over 45°C / thermal protection (3)	
3 kVac / 60 s SELV output	
1.5 kVac / 60 s	
0.5 kVac / 60 s	
EN 60950-1+A1+A2+A12, UL 508	
EN61000-6-1, EN61000-6-2, EN61000-6-3, EN61000-6-4	
>500'000 h according to SN 29500 / >150'000 h according to MIL Std. HDBK 217F	
II / 2	
IP 20 IEC 529, EN60529	
2.5 mm <sup>2</sup> removable screw terminal blocks	
aluminium	
400 g	
vertical on rail, allow 10 mm spacing between adjacent components	

## MOUNTING ACCESSORIES

- Mounting rail type according to IEC60715/TH35-7.5
- Mounting rail type according to IEC60715/G32

<b>PR/3/AC, PR/3/AC/ZB, PR/3/AS, PR/3/AS/ZB</b>
-

# Single-phase switching power supply 120-230 Vac - output power 120 W

- Single-phase input 90...264 Vac and DC 100...345 Vdc
- Short circuit, overload, over temperature and overvoltage input and output protection
- Elevated outrush current to ensure the selectivity of protections and start-up of heavy loads
- Failure contact with threshold  $U_{out} - 10\%$
- Compact dimensions
- Suitable for SELV and PELV circuits

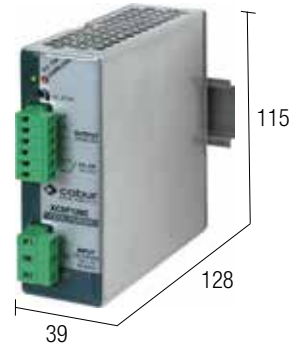

## NOTES

- The depth measurement includes terminal block and rail clamp clearance.
- (2) With an input powered at 100...127 Vdc, using constant power and  $T_a > 45^\circ\text{C}$ , the outrush current is reduced by 25%
- (3) Over  $45^\circ\text{C}$  apply a derating  $-0.08\text{ A}/^\circ\text{C}$  for version C, CP and CPH;  $-0.12\text{ A}/^\circ\text{C}$  for version B;  $-0.05\text{ A}/^\circ\text{C}$  for version DP;
- (4) For this peak of power, the output voltage does not decrease more than 10% of the rated value, however the value of the current supplied by the power supply also depends on the line resistance.

## BLOCK DIAGRAM

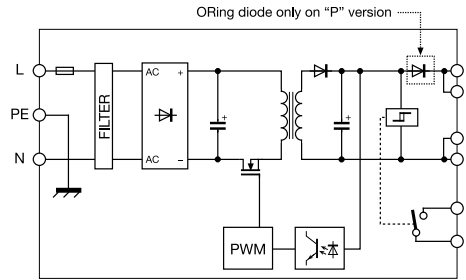

## VERSIONS

- Output 24 Vdc 5 A
- Output 24 Vdc 5 A redundant version
- Output 12...15 Vdc 7 A
- Output 48 Vdc 2.5 A redundant version

## INPUT TECHNICAL DATA

Input rated voltage	120-230 Vac (range 90...264 Vac / 100...345 Vdc) (2)
Frequency	47...63 Hz
Current with nominal Iout (Uin 120 / 230 Vac)	1.9 A / 1.1 A $\pm 10\%$
Inrush peak current	< 20 A
Power factor	> 0.65
Internal protection fuse	Replaceable T 3.15 A
External protection on AC line	circuit breaker 4 A characteristic C - fuses: T 4 A

## OUTPUT TECHNICAL DATA

Output rated voltage	<b>24 Vdc</b>	<b>48 Vdc</b>
Output adjustable range	23...27.5 Vdc	45...55 Vdc
Continuous current	<b>5 A</b> at $45^\circ\text{C}$ (3)	<b>2.5 A</b> at $45^\circ\text{C}$ (3)
Overload limiting current	8 A for >30 s with $U_{out} > 90\% U_n$ (4)	8 A for >30 s with $U_{out} > 90\% U_n$ (4)
Short circuit peak current	15 A for 50 ms (4)	7.5 A for 50 ms (4)
Load regulation	< 1%	< 1%
Ripple at nominal ratings	$\leq 30\text{ mVpp}$	$\leq 30\text{ mVpp}$
Hold up time (Uin 120 / 230 Vac)	>17 ms / >72 ms	>16 ms / >81 ms
Overload / short circuit protections	hiccup at the overload limit with auto reset/thermal protection	
Status display	Green LED "DC OK" / failure contact "DC OK" / Red LED "Overload"	
Alarm contact threshold	<21.6 Vdc	<43.2 Vdc
Parallel connection	possible	possible
Redundant parallel connection	possible with external ORing diode	already fitted with internal ORing diode

## GENERAL TECHNICAL DATA

Efficiency (Uin 120 / 230 Vac)	>86% / >90%	>86% / >90%
Dissipated power (Uin 120 / 230 Vac)	19 W / 13 W	20 W / 13 W
Operating temperature range	$-20...+60^\circ\text{C}$ , with derating over $45^\circ\text{C}$ / thermal protection (3)	
Input/output isolation	3 kVac / 60 s SELV output	
Input/PE isolation	1.5 kVac / 60 s	
Output/PE isolation	0.5 kVac / 60 s	
Safety standards	EN 60950-1+A1+A2+A12, UL 508	
Electromagnetic compatibility	EN61000-6-1, EN61000-6-2, EN61000-6-3, EN61000-6-4	
MTBF at $25^\circ\text{C}$ and nominal ratings	>500'000 h according to SN 29500 / >150'000 h according to MIL Std. HDBK 217F	
Overvoltage category / Pollution degree	II / 2	
Protection degree	IP 20 IEC 529, EN60529	
Connection type	2.5 mm <sup>2</sup> removable screw terminal blocks	
Housing material	aluminium	
Approximate weight	400 g	
Mounting information	vertical on rail, allow 10 mm spacing between adjacent components	

## MOUNTING ACCESSORIES

- Mounting rail type according to IEC60715/TH35-7.5
- Mounting rail type according to IEC60715/G32

PR/3/AC, PR/3/AC/ZB, PR/3/AS, PR/3/AS/ZB

# Single-phase switching power supply 120-230 Vac - output power 240 W

- Single-phase input 120 and 230 Vac
- Short circuit, overload, over temperature and overvoltage input and output protection
- Elevated outrush current to ensure the selectivity of protections and start-up of heavy loads
- Failure contact with threshold  $U_{out} - 10\%$
- Compact dimensions
- Suitable for SELV and PELV circuits

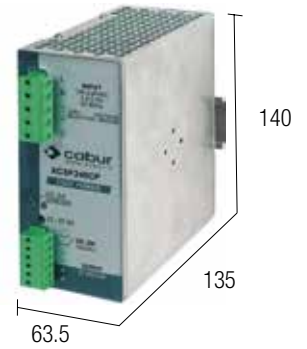

## NOTES

- The depth measurement includes terminal block and rail clamp clearance.
- (2) Double range input with selection via external bridge, direct current power supply only between 300 and 345 Vdc
  - (3) Over 45°C apply the following derating: -0.17 A/°C for version C, CP and CPH; -0.27 A/°C for version B; -0.08 A/°C for version DP;
  - (4) For this peak of power, the output voltage does not decrease more than 10% of the rated value, however the value of the current supplied by the power supply also depends on the line resistance.

## BLOCK DIAGRAM

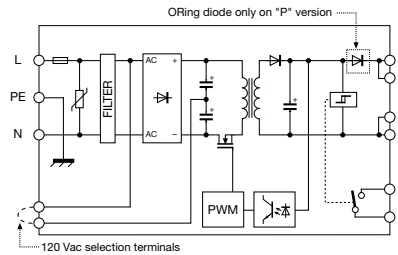

## VERSIONS

- Output 24 Vdc 10 A
- Output 24 Vdc 10 A redundant version
- Output 12...15 Vdc 16 A
- Output 48 Vdc 5 A redundant version

## INPUT TECHNICAL DATA

- Input rated voltage
- Frequency
- Current with nominal Iout (Uin 120 / 230 Vac)
- Inrush peak current
- Power factor
- Internal protection fuse
- External protection on AC line

## OUTPUT TECHNICAL DATA

- Output rated voltage
- Output adjustable range
- Continuous current
- Overload limiting current
- Short circuit peak current
- Load regulation
- Ripple at nominal ratings
- Hold up time (Uin 120 / 230 Vac)
- Overload / short circuit protections
- Status display
- Alarm contact threshold
- Parallel connection
- Redundant parallel connection

## GENERAL TECHNICAL DATA

- Efficiency (Uin 120 / 230 Vac)
- Dissipated power (Uin 120 / 230 Vac)
- Operating temperature range
- Input/output isolation
- Input/PE isolation
- Output/PE isolation
- Safety standards
- Electromagnetic compatibility
- MTBF at 25°C and nominal ratings
- Overvoltage category / Pollution degree
- Protection degree
- Connection type
- Housing material
- Approximate weight
- Mounting information

## MOUNTING ACCESSORIES

- Mounting rail type according to IEC60715/TH35-7.5
- Mounting rail type according to IEC60715/G32

## Code XCSF240C

CSF240C

## Code XCSF240CP

CSF240CP

## XCSF240DP

CSF240DP

**120 - 230 Vac** (range 90...132 Vac / 185...264 Vac / 300...345 Vdc) (2)

47...63 Hz

3.5 A / 1.8 A ± 10%

< 35 A

> 0.6

Replaceable T 6.3 A

circuit breaker 10 A characteristic C - fuses: T 10 A

### 24 Vdc

23...27.5 Vdc

**10 A** at 45°C (3)

15 A for >30 s

with Uout >90% Un (4)

>25 A for 400 ms (4)

< 1%

≤ 50 mVpp

>30 ms / >60 ms

hiccup at the overload limit with auto reset/thermal protection

Green LED "DC OK" / failure contact "DC OK" / Red LED "Overload"

21.6 Vdc

possible

possible with external ORing diode

already fitted with internal ORing diode

### 48 Vdc

45...55 Vdc

**5 A** at 45°C (3)

7.5 A for >30 s

with Uout >90% Un (4)

>25 A for 400 ms (4)

< 1%

≤ 50 mVpp

>30 ms / >60 ms

43.2 Vdc

possible

already fitted with internal ORing diode

>88% / >90%

32 W / 27 W

-20...+60°C, with derating over 45°C / thermal protection (3)

3 kVac / 60 s SELV output

1.5 kVac / 60 s

0.5 kVac / 60 s

EN 60950-1+A1+A2+A12, UL 508

EN61000-6-1, EN61000-6-2, EN61000-6-3, EN61000-6-4

>500'000 h according to SN 29500 / >150'000 h according to MIL Std. HDBK 217F

II / 2

IP 20 IEC 529, EN60529

2.5 mm² removable screw terminal blocks

aluminium

920 g

vertical on rail, allow 10 mm spacing between adjacent components

**PR/3/AC, PR/3/AC/ZB, PR/3/AS, PR/3/AS/ZB**

# Single-phase switching power supply 120-230 Vac - output power 500 W

- Single-phase input 120 and 230 Vac
- Short circuit, overload, over temperature and overvoltage input and output protection
- Elevated outrush current to ensure the selectivity of protections and start-up of heavy loads
- Compact dimensions
- Suitable for SELV and PELV circuits
- Failure contact with threshold  $U_{out} - 10\%$

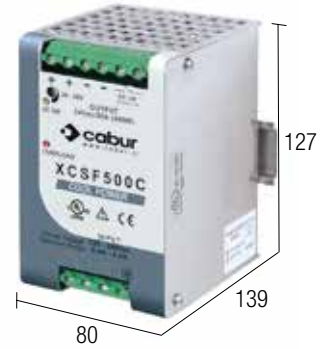

## NOTES

- The depth measurement includes rail clamp clearance.
- (2) Dual voltage input with selection through external jumper.
  - (3) Over 45°C apply the following derating:  
-0.34 A/°C for version C; -0.17 A/°C for version D.
  - (4) For this peak of power, the output voltage does not decrease more than 10% of the rated value, however the value of the current supplied by the power supply also depends on the line resistance.

## BLOCK DIAGRAM

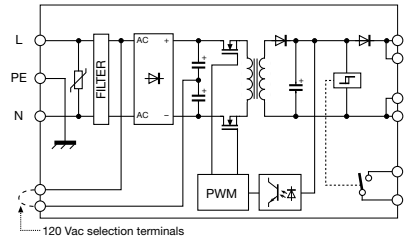

## VERSIONS

- Output 24 Vdc 20 A
- Output 24 Vdc 20 A redundant version
- Output 12...15 Vdc 40 A
- Output 48 Vdc 10 A redundant version

## INPUT TECHNICAL DATA

Input rated voltage	120-230 Vac (range 90...132 Vac / 185...264 Vac) (2)
Frequency	47...63 Hz
Current with nominal Iout (Uin 120 / 230 Vac)	4.1 A / 2 A ± 10%
Inrush peak current	< 25 A with electronic limiter
Power factor	> 0.75 with PFC
Internal protection fuse	—
External protection on AC line	circuit breaker 16 A characteristic C - fuses: T 15 A

## OUTPUT TECHNICAL DATA

Output rated voltage	24 Vdc	48 Vdc
Output adjustable range	24...28 Vdc	45...55 Vdc
Continuous current	20 A at 45°C (3)	10 A at 45°C (3)
Overload limiting current	30 A for >5 s with Uout >90% Un (4)	15 A for >5 s with Uout >90% Un (4)
Short circuit peak current	>50 A for 5 s (4)	>50 A for 5 s (4)
Load regulation	< 0.5%	< 0.5%
Ripple at nominal ratings	≤ 50 mVpp	≤ 50 mVpp
Hold up time (Uin 120 / 230 Vac)	>12 ms / >20 ms	>12 ms / >20 ms
Overload / short circuit protections	hiccup at the overload limit with auto reset/thermal protection	
Status display	Green LED "DC OK" / failure contact "DC OK" / Red LED "Overload"	
Alarm contact threshold	21.6 Vdc (5)	43.2 Vdc (5)
Parallel connection	possible	possible
Redundant parallel connection	already fitted with internal ORing diode	already fitted with internal ORing diode

## GENERAL TECHNICAL DATA

Efficiency (Uin 120 / 230 Vac)	>92% / >92%	>92% / >92%
Dissipated power (Uin 120 / 230 Vac)	42 W / 42 W	42 W / 42 W
Operating temperature range	-20...+60°C, with derating over 45°C / thermal protection (3)	
Input/output isolation	3 kVac / 60 s SELV output	
Input/PE isolation	1.5 kVac / 60 s	
Output/PE isolation	0.5 kVac / 60 s	
Safety standards	EN 60950-1+A1+A2+A12, UL 508	
Electromagnetic compatibility	EN61000-6-1, EN61000-6-2, EN61000-6-3, EN61000-6-4	
MTBF at 25°C and nominal ratings	>500'000 h according to SN 29500 / >150'000 h according to MIL Std. HDBK 217F	
Overvoltage category / Pollution degree	II / 2	
Protection degree	IP 20 IEC 529, EN60529	
Connection type	4 and 6 mm² screw-clamp terminal blocks	
Housing material	aluminium	
Approximate weight	1.3 kg	
Mounting information	vertical on rail, allow 10 mm spacing between adjacent components	

## MOUNTING ACCESSORIES

Mounting rail type according to IEC60715/TH35-7.5	PR/3/AC, PR/3/AC/ZB, PR/3/AS, PR/3/AS/ZB
Mounting rail type according to IEC60715/G32	—

	Code XCSF500C	Code XCSF500D
	—	—
	CSF500C	—
	—	CSF500D

# Single-phase switching power supply 120-230 Vac in IP65 case

- Single-phase input 90...264 Vac and DC 100...345 Vdc
- Short circuit, overload, over temperature and overvoltage input and output protection
- Suitable for installation directly on-board the machine, requiring no protective coating
- With removable screw-fixed IP65 connector
- Suitable for SELV and PELV circuits



## NOTES

The depth measurement includes terminal block and rail clamp clearance.

- (1) With an input powered at 100...127 Vdc, using constant power and  $T_a > 45^\circ\text{C}$ , the outrush current is reduced by 25%
- (2) The value of the current supplied by the power supply also depends on the line resistance.
- (3) Version made to order (not kept in stock); contact our sales office for availability.

## BLOCK DIAGRAM

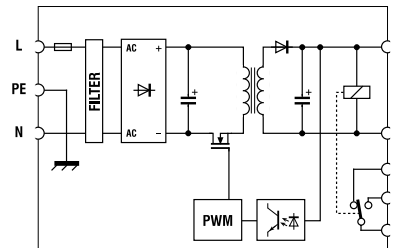

## VERSIONS

Output 24 Vdc 5 A

Code XCSF565

CSF5-65 (3)

## INPUT TECHNICAL DATA

Input rated voltage	<b>120-230 Vac</b> (range 90...264 Vac / 100...345 Vdc) (1)
Frequency	47...63 Hz
Current with nominal Iout (Uin 120 / 230 Vac)	1.8 A / 1 A $\pm$ 10%
Inrush peak current	< 20 A
Power factor	> 0.7
Internal protection fuse	Replaceable T 3.15 A
External protection on AC line	circuit breaker 4 A characteristic C - fuses: T 4 A

## OUTPUT TECHNICAL DATA

Output rated voltage	<b>24 Vdc</b>
Output adjustable range	23...27.5 Vdc
Continuous current	<b>5 A</b> at 60°C
Overload limiting current	8 A (2)
Short circuit peak current	—
Load regulation	< 1%
Ripple at nominal ratings	$\leq$ 50 mVpp
Hold up time (Uin 120 / 230 Vac)	>10 ms / >20 ms
Overload / short circuit protections	hiccup at the overload limit with auto reset/thermal protection
Status display	Green LED "DC OK" / failure contact "DC OK"
Alarm contact threshold	—
Parallel connection	possible
Redundant parallel connection	possible with external ORing diode

## GENERAL TECHNICAL DATA

Efficiency (Uin 120 / 230 Vac)	>86% / >90%
Dissipated power (Uin 120 / 230 Vac)	18.6 W / 12.6 W
Operating temperature range	-20...+60°C / thermal protection
Input/output isolation	3 kVac / 60 s SELV output
Input/PE isolation	1.5 kVac / 60 s
Output/PE isolation	0.5 kVac / 60 s
Safety standards	EN 60950-1+A1+A2+A12, UL 508
Electromagnetic compatibility	EN61000-6-1, EN61000-6-2, EN61000-6-3, EN61000-6-4
MTBF at 25°C and nominal ratings	>500'000 h according to SN 29500 / >150'000 h according to MIL Std. HDBK 217F
Overvoltage category / Pollution degree	II / 2
Protection degree	IP 20 IEC 529, EN60529
Connection type	2.5 mm <sup>2</sup> removable screw IP65 connectors
Housing material	aluminium
Approximate weight	1.9 kg
Mounting information	vertical on rail or screwed to panel

## MOUNTING ACCESSORIES

Mounting rail type according to IEC60715/TH35-7.5	<b>PR/3/AC, PR/3/AC/ZB, PR/3/AS, PR/3/AS/ZB</b>
Mounting rail type according to IEC60715/G32	—



# Switching power supply - CSL Series

## EASY POWER

**Single-phase switching power supply for DIN-rail**, for general applications in automation and installation. Offering excellent value for money, these offer a perfect and convenient solution for uses in which the powered loads do not require strong peak currents.

They can deliver over +50% of nominal current for a sustained period, keeping the output voltage stable and ensuring continuity of supply to the system. **With these features, this range of power supplies enables designers to meet the requirements of the Machinery Directive EN 60204-1**, allowing the protection devices connected to the output to trigger quickly, safely and selectively, thus ensuring continuity of service to the other parts of the system.

### Suggested uses

- Civil automation applications
- General applications in plant installations

### Main features

- Equipped with a 120-230 Vac input, these are suitable for use in all single-phase networks
- High efficiency reduces energy consumption and the operating temperature of components and allows use in small panels and severe environmental conditions.
- Power reserve +50% of nominal current, ensuring safety and reliability.
- Output voltage is adjustable and protected against incoming surge generated by inductive loads on the DC line, and is equipped with a double electronic protection that prevents the powered device from failing in case of an internal malfunction.
- Short-circuit, overload and thermal protection prevents faults in case of prolonged overload with high ambient temperatures.
- Construction ensures optimal capacity of ventilation of internal components, extremely reduced overall dimensions and degree of protection IP20 by accidental contact according to IEC529.
- Offer superior performance, features and reliability compared to other products of a similar power and cost.



**-circuit, overload and thermal protection** Prevents faults in case of prolonged overload with high ambient temperatures

### Adjustable output voltage

Protected against incoming surge generated by inductive loads on the DC line

### Power boost

The output power reaches 120% of the nominal value for several minutes, up to 150% in the event of overload, and up to 300% during a short-circuit, to enable the protection devices connected to the output to trigger quickly, safely and selectively, without the use of additional modules.

### Extremely compact dimensions

Among the smallest on the market, optimising the use of space in the panel without compromising performance

### High performance

Reduces the energy consumption and operating temperature of components and allows for use in small panels and in severe ambient conditions



# Single-phase switching power supply 120-230 Vac - output power 85 W

- Single-phase input 90...264 Vac
- Short circuit, overload, over temperature and overvoltage input and output protection
- Ideal for general installation and application environments
- Suitable for SELV and PELV circuits

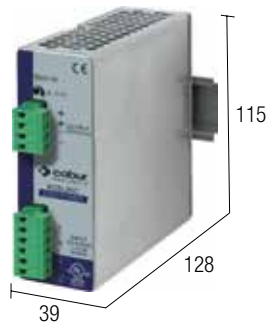

## NOTES

The depth measurement includes terminal block and rail clamp clearance.

(3) Over 45°C apply a derating of -0.06 A/°C

(4) For this peak of power, the output voltage does not decrease more than 10% of the rated value, however the value of the current supplied by the power supply also depends on the line resistance.

## BLOCK DIAGRAM

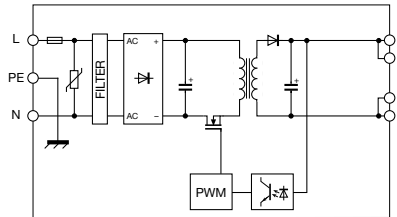

## VERSIONS

Output 24 Vdc 3.5 A

Code XCSL85C

CSL85C

## INPUT TECHNICAL DATA

Input rated voltage

Frequency

Current with nominal Iout (Uin 120 / 230 Vac)

Inrush peak current

Power factor

Internal protection fuse

External protection on AC line

**120-230 Vac** (range 90...264 Vac)

47...63 Hz

1.6A / 0.9 A ± 10%

< 20 A

> 0.65

Replaceable T 2 A

circuit breaker 4 A characteristic C - fuses: T 4 A

## OUTPUT TECHNICAL DATA

Output rated voltage

Output adjustable range

Continuous current

Overload limiting current

Short circuit peak current

Load regulation

Ripple at nominal ratings

Hold up time (Uin 120 / 230 Vac)

Overload / short circuit protections

Status display

Alarm contact threshold

Parallel connection

Redundant parallel connection

**24 Vdc**

23...27.5 Vdc

**3.5 A** at 45°C (3)

5.5 A for >30 s with Uout >90% Un (4)

9 A for 50 ms

< 1%

70 mVpp

>20 ms / >70 ms

hiccup at the overload limit with auto reset/thermal protection

Green LED "DC OK"

—

possible

possible with external ORing diode

## GENERAL TECHNICAL DATA

Efficiency (Uin 120 / 230 Vac)

Dissipated power (Uin 120 / 230 Vac)

Operating temperature range

Input/output isolation

Input/PE isolation

Output/PE isolation

Safety standards

Electromagnetic compatibility

MTBF at 25°C and nominal ratings

>86% / >90%

14 W / 10 W

-20...+60°C, with derating over 45°C/thermal protection (3)

3 kVac / 60 s SELV output

1.5 kVac / 60 s

0.5 kVac / 60 s

EN 60950-1+A1+A2+A12, UL 508

EN61000-6-1, EN61000-6-2, EN61000-6-3, EN61000-6-4

>400'000 h according to SN 29500 / >100'000 h according to

MIL Std. HDBK 217F

II / 2

IP 20 IEC 529, EN60529

2.5 mm<sup>2</sup> removable screw terminal blocks

aluminium and stainless steel

400 g

vertical on rail, allow 10 mm spacing between adjacent components

## MOUNTING ACCESSORIES

Mounting rail type according to IEC60715/TH35-7.5

Mounting rail type according to IEC60715/G32

PR/3/AC, PR/3/AC/ZB, PR/3/AS, PR/3/AS/ZB



# Single-phase switching power supply 120-230 Vac - output power 120 W

- Single-phase input 90...264 Vac
- Short circuit, overload, over temperature and overvoltage input and output protection
- Ideal for general installation and application environments
- Suitable for SELV and PELV circuits

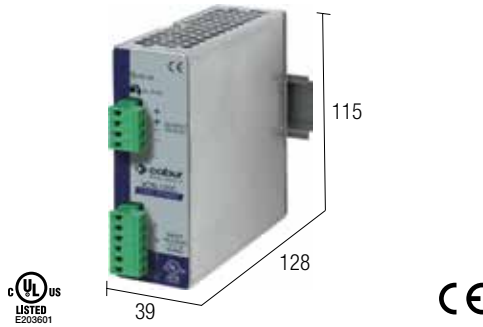

## NOTES

The depth measurement includes terminal block and rail clamp clearance.

(3) Over 45°C apply a derating of -0.08 A/°C

(4) For this peak of power, the output voltage does not decrease more than 10% of the rated value, however the value of the current supplied by the power supply also depends on the line resistance.

## BLOCK DIAGRAM

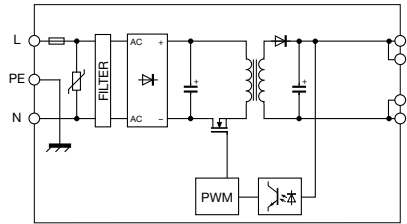

## VERSIONS

Output 24 Vdc 5 A

## Code XCSSL20C

CSL120C

## INPUT TECHNICAL DATA

Input rated voltage

Frequency

Current with nominal Iout (Uin 120 / 230 Vac)

Inrush peak current

Power factor

Internal protection fuse

External protection on AC line

**120-230 Vac** (range 90...264 Vac)

47...63 Hz

1.9 A / 1.1 A ± 10%

< 20 A

> 0.65

Replaceable T 3.15 A

circuit breaker 4 A characteristic C - fuses: T 4 A

## OUTPUT TECHNICAL DATA

Output rated voltage

Output adjustable range

Continuous current

Overload limiting current

Short circuit peak current

Load regulation

Ripple at nominal ratings

Hold up time (Uin 120 / 230 Vac)

Overload / short circuit protections

Status display

Alarm contact threshold

Parallel connection

Redundant parallel connection

**24 Vdc**

23...27.5 Vdc

**5 A** at 45°C (3)

8 A for >30 s with Uout >90% Un (4)

13 A for 50 ms (4)

< 1%

30 mVpp

>17 ms / >72 ms

hiccup at the overload limit with auto reset/thermal protection

Green LED "DC OK"

—

possible

possible with external ORing diode

## GENERAL TECHNICAL DATA

Efficiency (Uin 120 / 230 Vac)

Dissipated power (Uin 120 / 230 Vac)

Operating temperature range

Input/output isolation

Input/PE isolation

Output/PE isolation

Safety standards

Electromagnetic compatibility

MTBF at 25°C and nominal ratings

>86% / >90%

19 W / 13 W

-20...+60°C, with derating over 45°C / thermal protection (3)

3 kVac / 60 s SELV output

1.5 kVac / 60 s

0.5 kVac / 60 s

EN 60950-1+A1+A2+A12, UL 508

EN61000-6-1, EN61000-6-2, EN61000-6-3, EN61000-6-4

>400'000 h according to SN 29500 / >100'000 h according to MIL Std. HDBK 217F

II / 2

IP 20 IEC 529, EN60529

2.5 mm<sup>2</sup> removable screw terminal blocks

aluminium and stainless steel

400 g

vertical on rail, allow 10 mm spacing between adjacent components

## MOUNTING ACCESSORIES

Mounting rail type according to IEC60715/TH35-7.5

Mounting rail type according to IEC60715/G32

PR/3/AC, PR/3/AC/ZB, PR/3/AS, PR/3/AS/ZB

—

# Single-phase switching power supply 120-230 Vac - output power 240 W

- Single-phase input 120 and 230 Vac
- Short circuit, overload, over temperature and overvoltage input and output protection
- Ideal for general installation and application environments
- Suitable for SELV and PELV circuits

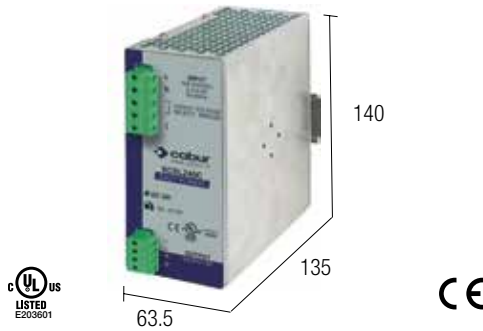

## NOTES

- The depth measurement includes terminal block and rail clamp clearance.
- (2) Dual voltage input with selection through external jumper.
  - (3) Over 45°C apply a derating equal to -0.17 A/°C
  - (4) For this peak of power, the output voltage does not decrease more than 10% of the rated value, however the value of the current supplied by the power supply also depends on the line resistance.
  - (5) Version available since September 2011

## BLOCK DIAGRAM

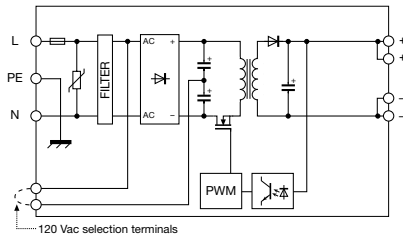

## VERSIONS

**Output 24 Vdc 10 A**

## Code XCSL240C

**CSL240C (5)**

## INPUT TECHNICAL DATA

Input rated voltage  
 Frequency  
 Current with nominal Iout (Uin 120 / 230 Vac)  
 Inrush peak current  
 Power factor  
 Internal protection fuse  
 External protection on AC line

**120-230 Vac** (range 90...132 Vac / 185...264 Vac) (2)  
 47...63 Hz  
 3.5A / 1.8 A ± 10%  
 < 35 A  
 > 0.6 / >0.85  
 Replaceable T 6.3 A  
 circuit breaker 10 A characteristic C - fuses: T 10 A

## OUTPUT TECHNICAL DATA

Output rated voltage  
 Output adjustable range  
 Continuous current  
 Overload limiting current  
 Short circuit peak current  
 Load regulation  
 Ripple at nominal ratings  
 Hold up time (Uin 120 / 230 Vac)  
 Overload / short circuit protections  
 Status display  
 Alarm contact threshold  
 Parallel connection  
 Redundant parallel connection

**24 Vdc**  
 23...27.5 Vdc  
**10 A** at 45°C (3)  
 15 A for >30 s with Uout >90% Un (4)  
 >25 A for 400 ms  
 < 1%  
 50 mVpp  
 >30 ms / >60 ms  
 hiccup at the overload limit with auto reset/thermal protection  
 Green LED "DC OK"  
 —  
 possible  
 possible with external ORing diode

## GENERAL TECHNICAL DATA

Efficiency (Uin 120 / 230 Vac)  
 Dissipated power (Uin 120 / 230 Vac)  
 Operating temperature range  
 Input/output isolation  
 Input/PE isolation  
 Output/PE isolation  
 Safety standards  
 Electromagnetic compatibility  
 MTBF at 25°C and nominal ratings  
 Overvoltage category / Pollution degree  
 Protection degree  
 Connection type  
 Housing material  
 Approximate weight  
 Mounting information

>88% / >90%  
 32 W / 27 W  
 -20...+60°C, with derating over 45°C / thermal protection (3)  
 3 kVac / 60 s SELV output  
 1.5 kVac / 60 s  
 0.5 kVac / 60 s  
 EN 60950-1+A1+A2+A12, UL 508  
 EN61000-6-1, EN61000-6-2, EN61000-6-3, EN61000-6-4  
 >400'000 h according to SN 29500 / >100'000 h according to MIL Std. HDBK 217F  
 II / 2  
 IP 20 IEC 529, EN60529  
 2.5 mm² removable screw terminal blocks  
 aluminium and stainless steel  
 920 g  
 vertical on rail, allow 10 mm spacing between adjacent components

## MOUNTING ACCESSORIES

Mounting rail type according to IEC60715/TH35-7.5  
 Mounting rail type according to IEC60715/G32

**PR/3/AC, PR/3/AC/ZB, PR/3/AS, PR/3/AS/ZB**  
 —

# Single-phase switching power supply 230 Vac - output power 480 W

- Single-phase input 230 Vac
- Short circuit, overload, over temperature and overvoltage input and output protection
- Ideal for general installation and application environments
- Suitable for SELV and PELV circuits

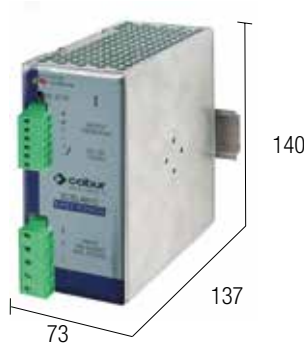

## NOTES

The depth measurement includes terminal block and rail clamp clearance.

(3) Over 45°C apply a derating equal to approximately 16 W/°C

(4) For this peak of power, the output voltage does not decrease more than 10% of the rated value, however the value of the current supplied by the power supply also depends on the line resistance.

## BLOCK DIAGRAM

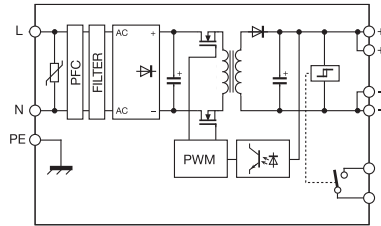

VERSIONS
Output 24 Vdc 20 A

Code XCSSL481C
CSL481C

INPUT TECHNICAL DATA
Input rated voltage
Frequency
Current with nominal Iout (Uin 120 / 230 Vac)
Inrush peak current
Power factor
Internal protection fuse
External protection on AC line

<b>230 Vac</b> (range 187...264 Vac) (2)
47...63 Hz
- / 2 A
<20 A
> 0.95
-
circuit breaker 6 A characteristic C - fuses: T 6.3 A

OUTPUT TECHNICAL DATA
Output rated voltage
Output adjustable range
Continuous current
Overload limiting current
Short circuit peak current
Load regulation
Ripple at nominal ratings
Hold up time (Uin 120 / 230 Vac)
Overload / short circuit protections
Status display
Alarm contact threshold
Parallel connection
Redundant parallel connection

<b>24 Vdc</b>
23...27.5 Vdc
<b>20 A</b> at 45°C (3)
28 A (4)
50 A for 0.3 s
< 1%
≤ 100 mVpp
- / >20 ms
hiccup at the overload limit with auto reset/thermal protection
Green LED "DC OK"
21.6 Vdc
possible
possible with external ORing diode

GENERAL TECHNICAL DATA
Efficiency (Uin 120 / 230 Vac)
Dissipated power (Uin 120 / 230 Vac)
Operating temperature range
Input/output isolation
Input/PE isolation
Output/PE isolation
Safety standards
Electromagnetic compatibility
MTBF at 25°C and nominal ratings
Overvoltage category / Pollution degree
Protection degree
Connection type
Housing material
Approximate weight
Mounting information

- / >92%
- / 42 W
-20...+60°C, with derating over 45°C / thermal protection (3)
3 kVac / 60 s SELV output
2 kVac / 60 s
0.5 kVac / 60 s
EN 60950-1+A11, UL 508
EN61000-6-2, EN61000-6-4
>500'000 h according to SN 29500 / >150'000 h according to MIL Std. HDBK 217F
II / 2
IP 20 IEC 529, EN60529
2.5 mm² removable screw terminal blocks
aluminium and stainless steel
1 kg
vertical on rail, allow 10 mm spacing between adjacent components

MOUNTING ACCESSORIES
Mounting rail type according to IEC60715/TH35-7.5
Mounting rail type according to IEC60715/G32

<b>PR/3/AC, PR/3/AC/ZB, PR/3/AS, PR/3/AS/ZB</b>
—

# Switching power supply - CSW Series

## UNIVERSAL POWER

**DIN-rail based switching power supply with universal input 185...550 Vac single/2 /3-phase** for industrial automation and process control applications. Input circuit technology makes these immune to overvoltage caused by faults in 3-phase networks with neutral, increasing the reliability of application.

This series offers **greater reliability in industrial environments** compared to single-phase power supplies. The input stage uses components with an operating voltage of 900 V, offering greater resistance to the voltage peaks present in industrial networks than single-phase components. The ability to operate from 185 to 550 Vac allows these power supplies to be used in both 230 V single-phase networks and 400 V 3-phase networks.

### Suggested uses

- Wherever maximum flexibility of use is required in single- or 3-phase networks
- Applications in industrial automation and process control
- Uses with heavy loads
- Civil automation applications

### Main features

- The 185...550 Vac extended range input is compatible with 230...240 Vac single-phase power, 208 Vac 2-phase and 400...500 Vac 2-phase and 3-phase for maximum adaptability to AC networks, eliminating the need for an isolation transformer.
- The 2-phase input offers reduced bulk, wiring, installation costs and panel space.
- Eliminates the need for a network voltage adaptation transformer.
- Versions with DC OK failure contact
- High efficiency reduces energy consumption and the operating temperature of components and allows use in small panels and severe environmental conditions.
- Large power reserve allows 5 seconds of current to be supplied at least +50% higher than the rated value, ensuring safety and reliability.
- The output is adjustable and protected against incoming surge from the DC line, and is equipped with electronic protection that turns off the output in case of an internal malfunction.
- Short-circuit and overload protection designed to supply peak currents of more than 150% of the rated value required by heavy loads, while the thermal protection prevents faults in case of prolonged overload with high ambient temperatures.
- Construction ensures excellent ventilation capacity of internal components, with reduced sizes and a degree of protection from accidental contacts of IP20 per IEC529.
- Thanks to their high performance and excellent ventilation, they are among the smallest on the market.

### Greater reliability

This series offers greater reliability in industrial environments compared to single-phase power supplies.

The input stage uses components with an operating voltage of 900 V, offering greater resistance to the voltage peaks present in industrial networks than single-phase components.

The ability to operate from 185 to 550 Vac makes these power supplies immune to network faults:

With the output powered at 230 Vac (1L-N), in case of a short in another device connected to L2-N, the neutral is increased to around 400 Vac and the input is powered phase-phase until the protection is opened, which in most cases occurs within 300 ms; this is one of the most frequent causes of malfunction in 230 Vac single-phase power supplies in industrial environments (figures 1 and 2)

Another type of fault in 230 Vac single-phase devices with phase-neutral power is due to the accidental disconnection or interruption of the panel neutral by the plant neutral: with no return to the star point, the neutral increases to phase voltage and applies to single-phase loads of around 400 Vac, and malfunction is inevitable.

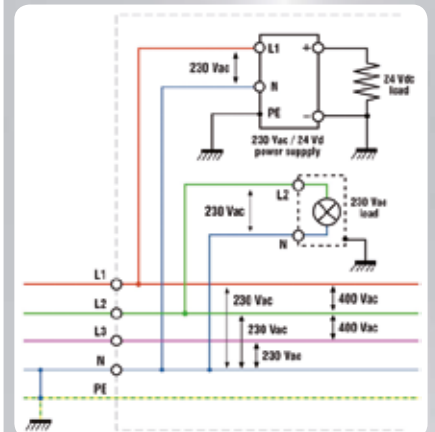

Typical application with 3-phase network with neutral. This is used to obtain a voltage of 230 Vac to power loads (a single lamp in the example) and power supplies.

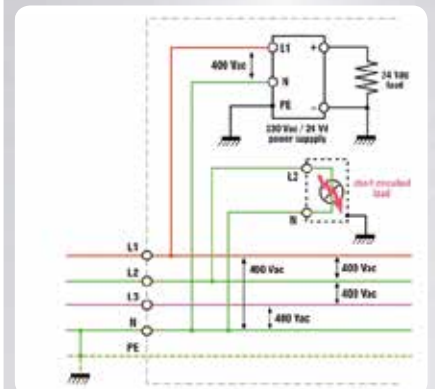

A single short-circuit on the load will raise the neutral potential and all devices connected to it will be powered between two phases, i.e. at around 340...400 Vac rather than 230 Vac.

### 185...550 Vac wide range input

Compatible with 230...240 Vac single-phase power, 208 Vac 2-phase and 400...500 Vac 2-phase and 3-phase for maximum adaptability to AC networks, eliminating the need for an isolation transformer.

### 2-phase input

Reduces clutter, wiring, installation costs

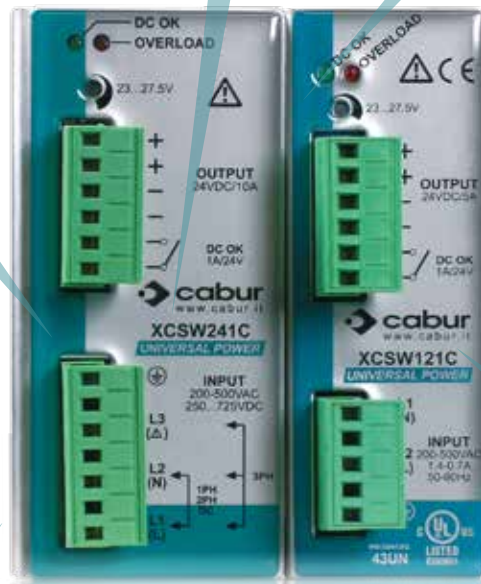

### Power boost

The output power reaches 120% of the nominal value for several minutes, up to 150% in the event of overload, and up to 250% during a short-circuit, to enable the protection devices connected to the output to trigger quickly, safely and selectively, without the use of additional modules.

### High performance

Reduces the energy consumption and operating temperature of components and allows for use in small panels

### Increased reliability in industrial environments

The input stage uses components with an operating voltage of 900 V, more resistant to the voltage peaks found in industrial networks

# 1 or 2-phase switching power supply 230-400-500 Vac - output power 120 W

- Single-phase and 2-phase input 185...550 Vac
- High reliability and surge immunity for network failures
- Short circuit, overload, over temperature and overvoltage input and output protection
- Elevated outrush current to ensure the selectivity of protections and start-up of heavy loads
- High efficiency and low consumption
- Suitable for SELV and PELV circuits

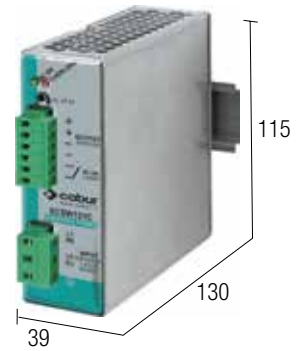

## NOTES

The depth measurement includes terminal block and rail clamp clearance.

- (1) Version made to order (not kept in stock); contact our sales office for availability.
- (2) 550 Vdc max for UL508
- (3) Over 45°C apply a derating equal to approximately 3 W/°C
- (4) For this peak of power, the output voltage does not decrease more than 10% of the rated value, however the value of the current supplied by the power supply also depends on the line resistance.

## BLOCK DIAGRAM

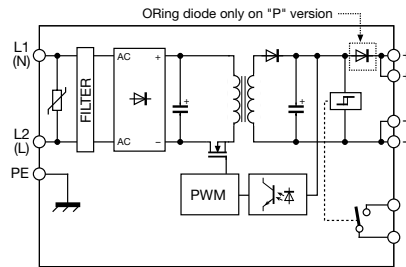

## VERSIONS

- Output 24 Vdc 5 A
- Output 12...15 Vdc 7 A
- Output 48 Vdc 2.5 A redundant version
- Output 72 Vdc 1.5 A redundant version

## INPUT TECHNICAL DATA

Input rated voltage	1-2x 230-400-500 Vac (range 187...550 Vac / 270...725 Vdc) (2)
Frequency	47...63 Hz
Current with nominal Iout (Uin 230 / 400 Vac)	1.1 A / 0.55 A
Inrush peak current	< 20 A
Power factor	> 0.65
Internal protection fuse	-
External protection on AC line	circuit breaker 2x 6 A characteristic C - fuse: 2x T 4 A

## OUTPUT TECHNICAL DATA

Output rated voltage	<b>24 Vdc</b>	<b>12...15 Vdc</b>
Output adjustable range	24...27.5 Vdc	12...15 Vdc
Continuous current	<b>5 A</b> (3)	<b>8 A</b> at 12 Vdc / <b>7 A</b> at 15 Vdc
Overload limiting current	7.5 A for >30 s with Uout >90% Un	10 A for >30 s with Uout >90% Un
Short circuit peak current	14 A for 0.4 s (4)	20 A for 0.4 s (4)
Load regulation	< 1%	< 1%
Ripple at nominal ratings	≤ 100 mVpp	≤ 100 mVpp
Hold up time (Uin 230 / 400 Vac)	>20 ms / >80 ms	>20 ms / >80 ms
Overload / short circuit protections	hiccup at the overload limit with auto reset/thermal protection	
Status display	Green LED "DC OK" / failure contact "DC OK" / Red LED "Overload"	
Alarm contact threshold	21.6 Vdc possible	10.8 Vdc possible
Parallel connection	possible with external ORing diode	possible with external ORing diode
Redundant parallel connection		

## GENERAL TECHNICAL DATA

Efficiency (Uin 230 / 400 Vac)	>87% / >87%	>84% / >86%
Dissipated power (Uin 230 / 400 Vac)	18 W / 18 W	20 W / 17 W
Operating temperature range	-20...+60°C, with derating over 45°C / thermal protection (3)	
Input/output isolation	3 kVac / 60 s SELV output	
Input/PE isolation	2 kVac / 60 s	
Output/PE isolation	0.5 kVac / 60 s	
Safety standards	EN 60950-1+A1+A2+A12, UL 508	
Electromagnetic compatibility	EN61000-6-1, EN61000-6-2, EN61000-6-3, EN61000-6-4	
MTBF at 25°C and nominal ratings	>500'000 h according to SN 29500 / >150'000 h according to MIL Std. HDBK 217F	
Overvoltage category / Pollution degree	II / 2	
Protection degree	IP 20 IEC 529, EN60529	
Connection type	2.5 mm² removable screw terminal blocks	
Housing material	aluminium and stainless steel	
Approximate weight	600 g	
Mounting information	vertical on rail, allow 10 mm spacing between adjacent components	

## MOUNTING ACCESSORIES

- Mounting rail type according to IEC60715/TH35-7.5
- Mounting rail type according to IEC60715/G32

**PR/3/AC, PR/3/AC/ZB, PR/3/AS, PR/3/AS/ZB**



# 1, 2 or 3-phase switching power supply 230-400-500 Vac - output power 240 W

- Single-phase, 2-phase and 3-phase input 185...550 Vac
- High reliability and surge immunity for network failures
- Short circuit, overload, over temperature and overvoltage input and output protection
- Elevated outrush current to ensure the selectivity of protections and start-up of heavy loads
- High efficiency and low consumption
- Suitable for SELV and PELV circuits

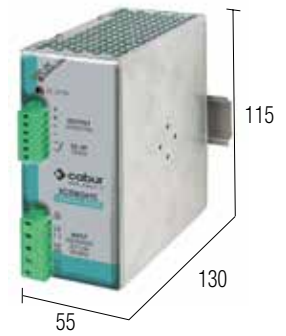

## NOTES

The depth measurement includes terminal block and rail clamp clearance.

- (1) Version made to order (not kept in stock); contact our sales office for availability.
- (2) 550 Vdc max for UL508
- (3) Over 50°C apply a derating equal to approximately 3 W/°C
- (4) For this peak of power, the output voltage does not decrease more than 10% of the rated value, however the value of the current supplied by the power supply also depends on the line resistance.
- (5) Version CSW241G not suitable for SELV applications.

## BLOCK DIAGRAM

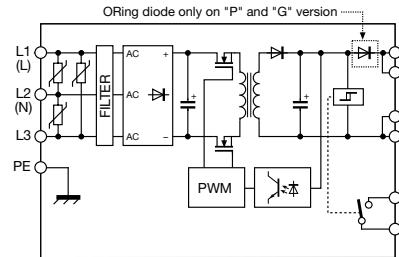

## VERSIONS

Output 24 Vdc 10 A

Output 12...15 Vdc 16...15 A

Output 48 Vdc 5 A redundant version

Output 72 Vdc 3.3 A redundant version

## INPUT TECHNICAL DATA

Input rated voltage

Frequency

Current with nominal Iout (Uin 230 / 400 Vac)

Inrush peak current

Power factor

Internal protection fuse

External protection on AC line

## OUTPUT TECHNICAL DATA

Output rated voltage

Output adjustable range

Continuous current

Overload limiting current

Short circuit peak current

Load regulation

Ripple at nominal ratings

Hold up time (Uin 230 / 400 Vac)

Overload / short circuit protections

Status display

Alarm contact threshold

Parallel connection

Redundant parallel connection

## GENERAL TECHNICAL DATA

Efficiency (Uin 230 / 400 Vac)

Dissipated power (Uin 230 / 400 Vac)

Operating temperature range

Input/output isolation

Input/PE isolation

Output/PE isolation

Safety standards

Electromagnetic compatibility

MTBF at 25°C and nominal ratings

Overvoltage category / Pollution degree

Protection degree

Connection type

Housing material

Approximate weight

Mounting information

## MOUNTING ACCESSORIES

Mounting rail type according to IEC60715/TH35-7.5

Mounting rail type according to IEC60715/G32

Code XCSW241C

Code XCSW241B

Code XCSW241DP

Code XCSW241G

CSW241C

CSW241B

CSW241DP (1)

CSW241G (1) (5)

1-2-3x **230-400-500 Vac** (range 185...550 Vac / 270...770 Vdc) (2)

47...63 Hz

2 A / 1 A

< 20 A

> 0.65

-

circuit breaker 2-3x 6 A characteristic C - fuse: 2-3x T 6.3 A

**24 Vdc**

**12...15 Vdc**

**48 Vdc**

**72 Vdc**

24...27.5 Vdc

12...15 Vdc

45...55 Vdc

72...85 Vdc

**10 A** at 50°C (3)

**16 A** at 12 Vdc / **15 A** at 15 Vdc

**5 A** at 50°C (3)

**3.5 A** (3)

15 A for >6 s

20...18 A for >6 s

6 A for >6 s

5 A for >6 s

with Uout >90% Un (4)

with Uout >90% Un (4)

with Uout >90% Un (4)

with Uout >90% Un (4)

38 A for 0.5 s (4)

34 A for 0.5 s (4)

18 A for 0.5 s (4)

13 A for 0.5 s (4)

< 1%

< 1%

< 1%

< 1%

≤ 100 mVpp

≤ 100 mVpp

100 mVpp

≤ 100 mVpp

>15 ms / >100 ms

>15 ms / >100 ms

>15 ms / >100 ms

>15 ms / >100 ms

hiccup at the overload limit with auto reset/thermal protection

Green LED "DC OK" / failure contact "DC OK" / Red LED "Overload"

21.6 Vdc

10.8 Vdc

43.2 Vdc

64.8 Vdc

possible

possible

possible

possible

possible with external ORing diode

possible with external ORing diode

already fitted with internal ORing diode

already fitted with internal ORing diode

>91% / >92%

>89% / >90%

>91% / >92%

>92% / >93%

24 W / 21 W

22 W / 20 W

24 W / 21 W

22 W / 19 W

-20...+60°C, with derating over 50°C / thermal protection (3)

3 kVac / 60 s SELV output (5)

2 kVac / 60 s

0.5 kVac / 60 s

EN 60950-1+A1+A2+A12, UL 508

EN61000-6-1, EN61000-6-2, EN61000-6-3, EN61000-6-4

>500'000 h according to SN 29500 / >150'000 h according to MIL Std. HDBK 217F

II / 2

IP 20 IEC 529, EN60529

2.5 mm<sup>2</sup> removable screw terminal blocks

aluminium and stainless steel

1 kg

vertical on rail, allow 10 mm spacing between adjacent components

**PR/3/AC, PR/3/AC/ZB, PR/3/AS, PR/3/AS/ZB**

# 1, 2 or 3-phase switching power supply 230-400-500 Vac - output power 480 W

- Single-phase, 2-phase and 3-phase input 185...550 Vac
- High reliability and surge immunity for network failures
- Short circuit, overload, over temperature and overvoltage input and output protection
- Elevated outrush current to ensure the selectivity of protections and start-up of heavy loads
- High efficiency and low consumption
- Suitable for SELV and PELV circuits

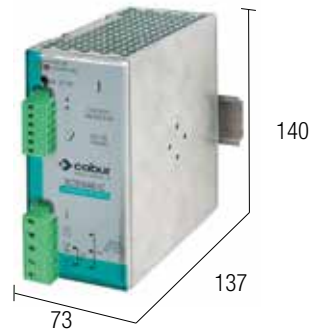

## NOTES

The depth measurement includes terminal block and rail clamp clearance.

- (1) Version made to order (not kept in stock); contact our sales office for availability.
- (2) 550 Vdc max for UL508
- (3) Over 45°C apply a derating equal to approximately 16 W/°C
- (4) For this peak of power, the output voltage does not decrease more than 10% of the rated value, however the value of the current supplied by the power supply also depends on the line resistance.
- (5) Version with 72 V output not suitable for SELV applications

## BLOCK DIAGRAM

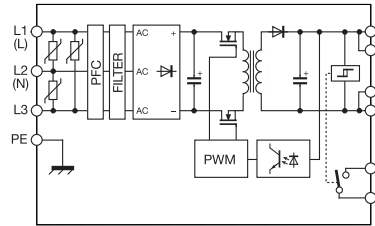

## VERSIONS

Output 24 Vdc 20 A

Output 12...15 Vdc 40 A

Output 48 Vdc 10 A

Output 72 Vdc 6 A

## INPUT TECHNICAL DATA

Input rated voltage

Frequency

Current with nominal Iout (Uin 230 / 400 Vac)

Inrush peak current

Power factor

Internal protection fuse

External protection on AC line

## OUTPUT TECHNICAL DATA

Output rated voltage

Output adjustable range

Continuous current

Overload limiting current

Short circuit peak current

Load regulation

Ripple at nominal ratings

Hold up time (Uin 230 / 400 Vac)

Overload / short circuit protections

Status display

Alarm contact threshold

Parallel connection

Redundant parallel connection

## GENERAL TECHNICAL DATA

Efficiency (Uin 230 / 400 Vac)

Dissipated power (Uin 230 / 400 Vac)

Operating temperature range

Input/output isolation

Input/PE isolation

Output/PE isolation

Safety standards

Electromagnetic compatibility

MTBF at 25°C and nominal ratings

Overvoltage category / Pollution degree

Protection degree

Connection type

Housing material

Approximate weight

Mounting information

## MOUNTING ACCESSORIES

Mounting rail type according to IEC60715/TH35-7.5

Mounting rail type according to IEC60715/G32

Code XCSW481C

CSW481C

Code XCSW481D

CSW481D

XCSW481G

CSW481G (1) (5)

1-2-3x 230-400-500 Vac (range 187...550 Vac / 250...725 Vdc) (2)

47...63 Hz

2.2 A / 1 A

<20 A / <40 A

> 0.95

-

circuit breaker 1-2-3x 6 A characteristic C - fuse: 1-2-3x T 6.3 A

**24 Vdc**

23.3...27.5 Vdc

**20 A** at 45°C (3)

28 A for >5 s

with Uout >90% Un (4)

50 A for 0.3 s (4)

< 1%

≤ 100 mVpp

>20 ms / >20 ms

**48 Vdc**

45...55 Vdc

**10 A** at 45°C (3)

14 A for >5 s

with Uout >90%Un (4)

25 A for 0.3 s (4)

< 1%

≤ 100 mVpp

>20 ms / >20 ms

**72 Vdc**

72...85 Vdc

**6 A** at 45°C (3)

9 A for >5 s

with Uout >90% Un (4)

12 A for 0.3 s (4)

< 1%

≤ 100 mVpp

>20 ms / >20 ms

hiccup at the overload limit with auto reset/thermal protection

Green LED "DC OK" / failure contact "DC OK" / Red LED "Overload"

21.6 Vdc

possible

possible with external ORing diode

43.2 Vdc

possible

possible with external ORing diode

64.8 Vdc

possible

possible with external ORing diode

>92% / >92%

42 W / 42 W

>92% / >92%

42 W / 42 W

>91% / >91%

42 W / 42 W

-20...+60°C, with derating over 50°C / thermal protection (3)

3 kVac / 60 s SELV output (5)

2 kVac / 60 s

0.5 kVac / 60 s

EN 60950-1+A11, UL 508

EN61000-6-2, EN61000-6-4

>500'000 h according to SN 29500 / >150'000 h according to MIL Std. HDBK 217F

II / 2

IP 20 IEC 529, EN60529

2.5 mm<sup>2</sup> removable screw terminal blocks

aluminium and stainless steel

1 kg

vertical on rail, allow 10 mm spacing between adjacent components

PR/3/AC, PR/3/AC/ZB, PR/3/AS, PR/3/AS/ZB

# Single-/two-phase switching power supplies 230-400-500 Vac - output power 960 W

- Single-phase, two-phase and three-phase input 185...480 Vac
- High reliability and surge immunity for network failures
- Short circuit, overload, overtemperature and surge input and output protection
- Elevated outrush current to ensure the selectivity of protections and start-up of heavy loads
- High efficiency and low consumption
- Suitable for SELV and PELV circuits



## NOTES

The depth measurement includes terminal block and rail clamp clearance.

- (1) Version made to order (not kept in stock); contact our sales office for availability.
- (2) Over 45°C apply a derating equal to approximately 32 W/°C
- (3) For this peak of power, the output voltage does not decrease more than 10% of the rated value, however the value of the current supplied by the power supply also depends on the line resistance.
- (4) Available with bridge

## BLOCK DIAGRAM

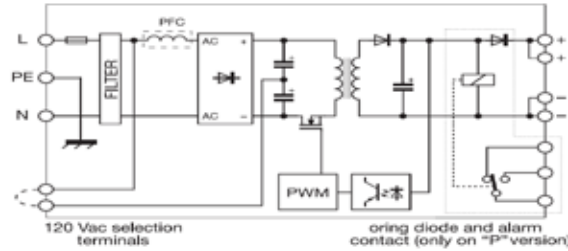

## VERSIONS

Output 24 Vdc 40 A redundant version

Code XCSW960CP			
CSW960CP	-		

## TECHNICAL DATA INPUT

Nominal input voltage  
Frequency  
Current with nominal Iout (Uin 230 / 400 Vac)  
Inrush peak current  
Power factor (at 230 Vac)  
Internal protection fuse  
External protection on the AC line

1x 230 Vac (range 180...264 Vac / 250...370 Vdc)	2x 400-500 Vac (range 360...550 Vac / 550...775 Vdc) (4)
	47...63 Hz
	4.7A at 230 Vac / 4A at 400 Vac
	<16 A
	> 0.6
	-
	circuit breaker 1-2x 10 A characteristic C - fuse: 1-2x T 10 A

## TECHNICAL DATA OUTPUT

Nominal output voltage  
Output adjustable range  
Continuous current  
Overload limiting current  
Short circuit peak current  
Load adjustment  
Ripple at nominal ratings  
Hold up time (Uin 230 / 400 Vac)  
Protection against short circuits and overload  
Status signals  
Activation threshold of the failure contact  
Parallel connection  
Redundant parallel connection

<b>24 Vdc</b>			
23...27.5 Vdc			
<b>40 A</b> at 45°C (2)			
50 A for >5 s with Uout >90% Un (4)			
65 A for 5 s (3)			
< 4%			
≤ 200 mVpp			
>20 ms			
	hiccup at the overload limit with auto reset / thermal protection		
	Green LED "DC OK" / failure contact "DC OK" / Red LED "Overload"		
21.6 Vdc			
possible			
possible with external ORing diode			

## GENERAL TECHNICAL DATA

Efficiency (Uin 230 / 400 Vac)  
Dissipated power (Uin 230 / 400 Vac)  
Operating temperature range  
Input/Output insulation  
Input/PE insulation  
Output/PE insulation  
Safety standards  
Electromagnetic compatibility  
MTBF at 25°C and nominal ratings  
Surge category / degree of pollution  
Degree of protection  
Connection type  
Container material  
Approximate weight  
Assembly

>90% at 230 Vac			
<100 W at 230 Vac			
	-20...+60°C, with derating above 45°C/thermal protection (2)		
	3 kVac / 60 s SELV output		
	2 kVac / 60 s		
	1 kVac / 60 s		
	EN 60950-1+A1+A2+A12		
	EN61000-6-1, EN61000-6-2, EN61000-6-3, EN61000-6-4		
	>500'000 h according to SN 29500 / >150'000 h according to MIL Std. HDBK 217F		
	II / 2		
	IP 20 IEC 529, EN60529		
	Input: 4 mm <sup>2</sup> screw terminal blocks / Output: 10 mm <sup>2</sup> screw terminal blocks		
	Aluminium		
	1.2 Kg		
	vertical on rail, space 10 mm from adjacent components		

## ACCESSORIES FOR ASSEMBLY

Mounting rail compliant with IEC60715/TH35-7.5  
Mounting rail compliant with IEC60715/G32

PR/3/AC, PR/3/AC/ZB, PR/3/AS, PR/3/AS/ZB			
--	--	--	--



# Switching power supply - CSG Series

## TRIPLE POWER

**400...500 Vac 3-phase switching power supply** for industrial automation applications. They can deliver over +50% of nominal current for a sustained period, keeping the output voltage stable and ensuring continuity of supply to the system. Equipped with voltage threshold controlled failure contact which is triggered when the voltage falls below 90% of the rated value.

**With these features and numerous international certifications, this range of power supplies enables designers to meet the requirements of the Machinery Directive EN 60204-1**, allowing the protection devices connected to the output to trigger quickly, safely and selectively, thus ensuring continuity of service to the other parts of the system.

### Suggested uses

- Applications in machine automation with high command and control voltage reliability and safety requirements
- In applications which require selectable overcurrent protections on DC lines
- Industrial automation applications
- Uses with heavy loads

### Main features

- With 340...550 Vac/507...770 Vdc input, making them suitable for use on all power supply networks.
- High efficiency reduces energy consumption and the operating temperature of components and allows use in small panels and severe environmental conditions.
- Large power reserve allows for delivery of at least +50% of nominal current for 5 seconds maintaining the output voltage stable, ensuring safety and reliability.
- Output voltage is adjustable and protected against incoming surge from the DC line, and is equipped with a double electronic protection that prevents damage to the powered device in case of an internal malfunction.
- Short-circuit and overload protection designed to deliver peak currents more than 150% higher than the rated value required by heavy loads.
- Thermal protection prevents faults in case of prolonged overload with high ambient temperatures.
- Construction ensures optimal capacity of ventilation of internal components, extremely reduced overall dimensions and degree of protection IP20 by accidental contact according to IEC529.

### Special power supplies for engines DC, Brushless, and relative drives

New 48Vdc, 72-85Vdc, and 110-180Vdc models have been introduced, designed to reliably power engines in DC. They:

- supply peak power equal to even 4-5 times the nominal current, which is required by the engine during the peak phase
- have an output stage protected from overvoltage generated by the engines and drives during braking, which could otherwise cause malfunctions or cause the power supply to lose control over output voltage stability
- Provide output voltage at 48Vdc, and 72...85Vdc. By increasing the voltage of the engine power supply, the same power can be obtained at lower current, with notable advantages for performance, engine construction, connection wires, and drives.



### Integrated smart alarm contact

Notifies when the output voltage falls below 90% of the nominal value once a threshold is surpassed

### Super compact size

Among the smallest on the market, optimising the use of space in the panel without compromising performance

### Power boost

The output power reaches 120% of the nominal value for several minutes, up to 150% in the event of overload, and up to 250% during a short-circuit, to enable the protection devices connected to the output to trigger quickly, safely and selectively, without the use of additional modules.

### Very high efficiency

Designed to save energy and reduce operating temperature



### Wide range

The widest range on the market, with power ratings from 120 to 2400W and output voltages of 24, 48 and 72 V, for uses including powering special motors

# 3-phase switching power supply 400-500 Vac - output power 480 W

- 3-phase 340...550 Vac or 2-phase with derating
- Short circuit, overload, over temperature and overvoltage input and output protection
- Elevated outrush current to ensure the selectivity of protections and start-up of heavy loads
- High efficiency and low consumption
- Suitable for SELV and PELV circuits

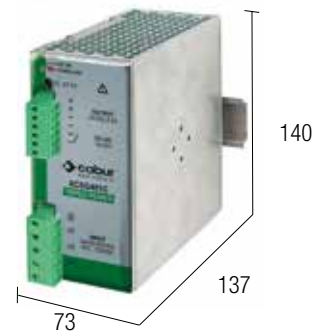

## NOTES

- The depth measurement includes rail clamp clearance.
- (3) Over 45°C apply a derating equal to approximately 16 W/°C
- (4) For this peak of power, the output voltage does not decrease more than 10% of the rated value, however the value of the current supplied by the power supply also depends on the line resistance.

## BLOCK DIAGRAM

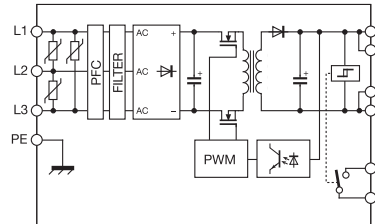

## VERSIONS

- Output 24 Vdc 20 A
- Output 12...15 Vdc 40 A
- Output 48 Vdc 10 A
- Output 72 Vdc 6 A

## Code XCSG481C

CSG481C

## INPUT TECHNICAL DATA

Input rated voltage	3x 400-500 Vac (range 340...550 Vac)
Frequency	47...63 Hz
Current with nominal Iout (Uin 400 / 500 Vac)	1.2 A / 0.8 A
Inrush peak current	<40 A
Power factor	> 0.95
Internal protection fuse	—
External protection on AC line	circuit breaker 3x 6 A characteristic C - fuse: 3x T 6.3 A

## OUTPUT TECHNICAL DATA

Output rated voltage	24 Vdc
Output adjustable range	23.3...27.5 Vdc
Continuous current	20 A at 45°C (3)
Overload limiting current	28 A for >5 s with Uout >90%Un (4)
Short circuit peak current	50 A for 0.3 s (4)
Load regulation	< 1%
Ripple at nominal ratings	≤ 100 mVpp
Hold up time (Uin 400 / 500 Vac)	>50 ms / >50 ms
Overload / short circuit protections	hiccup at limit current with auto reset/thermal protection (3)
Status display	Green LED "DC OK" / failure contact "DC OK"
Alarm contact threshold	21.6 Vdc
Parallel connection	possible
Redundant parallel connection	possible with external ORing diode

## GENERAL TECHNICAL DATA

Efficiency (Uin 400 / 500 Vac)	>93% / >92%
Dissipated power (Uin 400 / 500 Vac)	36 W / 42 W
Operating temperature range	-20...+60°C, with derating over 50°C / thermal protection (3)
Input/output isolation	3 kVac / 60 s SELV output
Input/PE isolation	2 kVac / 60 s
Output/PE isolation	0.5 kVac / 60 s
Safety standards	EN 60950-1+A11, UL 508
Electromagnetic compatibility	EN61000-6-2, EN61000-6-4
MTBF at 25°C and nominal ratings	>500'000 h according to SN 29500 / >150'000 h according to MIL Std. HDBK 217F
Overvoltage category / Pollution degree	II / 2
Protection degree	IP 20 IEC 529, EN60529
Connection type	2.5 mm² fixed screw terminal blocks
Housing material	aluminium
Approximate weight	1 kg
Mounting information	vertical on rail, allow 10 mm spacing between adjacent components

## MOUNTING ACCESSORIES

Mounting rail type according to IEC60715/TH35-7.5	PR/3/AC, PR/3/AC/ZB, PR/3/AS, PR/3/AS/ZB
Mounting rail type according to IEC60715/G32	—

# 3-phase switching power supply 400-500 Vac - output power 500 W

- 3-phase 340...550 Vac or 2-phase with derating
- Short circuit, overload, over temperature and overvoltage input and output protection
- Elevated outrush current to ensure the selectivity of protections and start-up of heavy loads
- High efficiency and low consumption
- Suitable for SELV and PELV circuits



## NOTES

- The depth measurement includes rail clamp clearance.
- (3) Over 50°C apply a derating equal to approximately 6 W/°C
- (4) For this peak of power, the output voltage does not decrease more than 10% of the rated value, however the value of the current supplied by the power supply also depends on the line resistance.

## BLOCK DIAGRAM

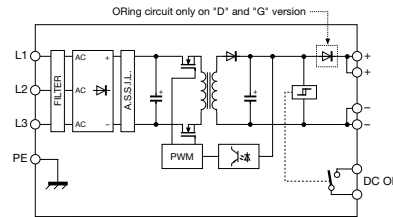

## VERSIONS

- Output 24 Vdc 20 A
- Output 12...15 Vdc 40 A
- Output 48 Vdc 10 A redundant version
- Output 72 Vdc 6.7 A redundant version

## Code XCSG500C

CSG500C

## INPUT TECHNICAL DATA

Input rated voltage	3x 400-500 Vac (range 340...550 Vac)
Frequency	47...63 Hz
Current with nominal Iout (Uin 400 / 500 Vac)	1 A / 0.6 A
Inrush peak current	< 35 A
Power factor	> 0.75 with PFC
Internal protection fuse	—
External protection on AC line	circuit breaker 10 A characteristic C - fuses: 3x T 10 A

## OUTPUT TECHNICAL DATA

Output rated voltage	24 Vdc
Output adjustable range	24...28 Vdc
Continuous current	20 A at 50°C (3)
Overload limiting current	>30 A for >5 s with Uout >90% Un (4)
Short circuit peak current	>60 A for 5 s (4)
Load regulation	< 0.5%
Ripple at nominal ratings	≤ 100 mVpp
Hold up time (Uin 400 / 500 Vac)	>15 ms / >30 ms
Overload / short circuit protections	limit current hiccup with auto reset/thermal protection
Status display	Green LED "DC OK" / failure contact "DC OK" / Red LED "Overload"
Alarm contact threshold	<21.6 Vdc
Parallel connection	possible
Redundant parallel connection	possible with external ORing diode

## GENERAL TECHNICAL DATA

Efficiency (Uin 400 / 500 Vac)	>93% / >93%
Dissipated power (Uin 400 / 500 Vac)	36 W / 36 W
Operating temperature range	-20...+60°C, with derating over 50°C / thermal protection (3)
Input/output isolation	3 kVac / 60 s SELV output (5)
Input/PE isolation	2 kVac / 60 s
Output/PE isolation	0.5 kVac / 60 s
Safety standards	EN 60950-1+A1+A2+A12, UL 508
Electromagnetic compatibility	EN61000-6-1, EN61000-6-2, EN61000-6-3, EN61000-6-4
MTBF at 25°C and nominal ratings	>500'000 h according to SN 29500 / >150'000 h according to MIL Std. HDBK 217F
Overvoltage category / Pollution degree	II / 2
Protection degree	IP 20 IEC 529, EN60529
Connection type	6 mm² fixed screw terminal blocks
Housing material	aluminium
Approximate weight	1.3 Kg
Mounting information	vertical on rail, allow 10 mm spacing between adjacent components

## MOUNTING ACCESSORIES

- Mounting rail type according to IEC60715/TH35-7.5
- Mounting rail type according to IEC60715/G32

PR/3/AC, PR/3/AC/ZB, PR/3/AS, PR/3/AS/ZB

# 3-phase switching power supply 400-500 Vac - output power 720 W

- 3-phase 340...550 Vac or 2-phase with derating
- Short circuit, overload, over temperature and overvoltage input and output protection
- Elevated outrush current to ensure the selectivity of protections and start-up of heavy loads
- High efficiency and low consumption
- Suitable for SELV and PELV circuits



## NOTES

The depth measurement includes rail clamp clearance.  
 (4) For this peak of power, the output voltage does not decrease more than 10% of the rated value, however the value of the current supplied by the power supply also depends on the line resistance.

## BLOCK DIAGRAM

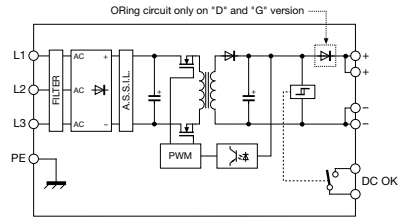

## VERSIONS

- Output 24 Vdc 30 A
- Output 12...15 Vdc 60 A
- Output 48 Vdc 15 A redundant version
- Output 72 Vdc 10 A redundant version

## Code XCSG720C

CSG720C

## INPUT TECHNICAL DATA

Input rated voltage	3x 400-500 Vac (range 340...550 Vac)
Frequency	47...63 Hz
Current with nominal Iout (Uin 400 / 500 Vac)	1.4 A / 1.1 A
Inrush peak current	< 30 A
Power factor	> 0.75
Internal protection fuse	—
External protection on AC line	magneto-thermal 3x 10 A curve C - fuses: 3x T 10 A

## OUTPUT TECHNICAL DATA

Output rated voltage	24 Vdc
Output adjustable range	24...28 Vdc
Continuous current	30 A at 50°C (3)
Overload limiting current	45 A for >5 s with Uout >90% Un (4)
Short circuit peak current	>80 A for 1.5 s (4)
Load regulation	< 1%
Ripple at nominal ratings	100 mVpp
Hold up time (Uin 400 / 500 Vac)	>10 ms / >15 ms
Overload / short circuit protections	limit current hiccup with auto reset/thermal protection/ASSIL protection
Status display	Green LED "DC OK" / failure contact "DC OK" / Red LED "Overload"
Alarm contact threshold	<21.6 Vdc
Parallel connection	possible
Redundant parallel connection	possible with external ORing diode

## GENERAL TECHNICAL DATA

Efficiency (Uin 400 / 500 Vac)	>92% / >92%
Dissipated power (Uin 400 / 500 Vac)	60 W / 60 W
Operating temperature range	-20...+60°C / thermal protection (3)
Input/output isolation	3 kVac / 60 s SELV output
Input/PE isolation	2 kVac / 60 s
Output/PE isolation	0.5 kVac / 60 s
Safety standards	EN 60950-1+A1+A2+A12, UL 508
Electromagnetic compatibility	EN61000-6-1, EN61000-6-2, EN61000-6-3, EN61000-6-4
MTBF at 25°C and nominal ratings	>500'000 h according to SN 29500 / >150'000 h according to MIL Std. HDBK 217F
Overvoltage category / Pollution degree	II / 2
Protection degree	IP 20 IEC 529, EN60529
Connection type	6 mm² fixed screw terminal blocks
Housing material	aluminium
Approximate weight	1.3 Kg
Mounting information	vertical on rail, allow 10 mm spacing between adjacent components

## MOUNTING ACCESSORIES

Mounting rail type according to IEC60715/TH35-7.5	PR/3/AC, PR/3/AC/ZB, PR/3/AS, PR/3/AS/ZB
Mounting rail type according to IEC60715/G32	—

# 3-phase switching power supply 400-500 Vac - output power 960 W

- 3-phase 340...550 Vac or 2-phase with derating
- Short circuit, overload, over temperature and overvoltage input and output protection
- Elevated outrush current to ensure the selectivity of protections and start-up of heavy loads
- High efficiency and low consumption
- Suitable for SELV and PELV circuits



## NOTES

- The depth measurement includes rail clamp clearance.
- (3) Over 45°C apply a derating equal to approximately 18 W/°C
- (4) For this peak of power, the output voltage does not decrease more than 10% of the rated value, however the value of the current supplied by the power supply also depends on the line resistance.
- (5) CSG960G version not suitable for SELV applications

## BLOCK DIAGRAM

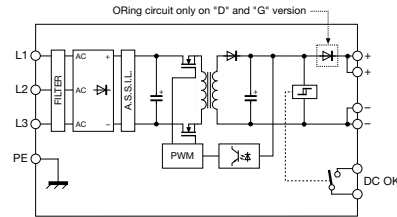

## VERSIONS

- Output 24 Vdc 40 A
- Output 12...15 Vdc 80 A
- Output 48 Vdc 20 A redundant version
- Output 72 Vdc 13.3 A redundant version (5)

## INPUT TECHNICAL DATA

Input rated voltage	3x 400-500 Vac (range 340...550 Vac)
Frequency	47...63 Hz
Current with nominal Iout (Uin 400 / 500 Vac)	2.2 A / 1.1 A
Inrush peak current	< 20 A
Power factor	> 0.65
Internal protection fuse	—
External protection on AC line	circuit breaker 3x 10 A characteristic C - fuses: 3x T 10 A

## OUTPUT TECHNICAL DATA

Output rated voltage	24...28 Vdc	48 Vdc	72 Vdc
Output adjustable range	24...28 Vdc	45...55 Vdc	72...85 Vdc
Continuous current	40 A at 50°C (3)	20 A at 50°C (3)	13.3 A at 50°C (3)
Overload limiting current	56 A for >5 s with Uout >90% Un (4)	28 A for >5 s with Uout >90% Un (4)	18.6 A for >5 s with Uout >90% Un (4)
Short circuit peak current	>90 A for 5 s (4)	>70 A for 5 s (4)	>30 A for 5 s (4)
Load regulation	< 1%	< 1%	< 1%
Ripple at nominal ratings	100 mVpp	100 mVpp	≤ 100 mVpp
Hold up time (Uin 400 / 500 Vac)	>10 ms / >15 ms	>10 ms / >15 ms	>15 ms / >18 ms
Overload / short circuit protections	limit current hiccup with auto reset/thermal protection		
Status display	Green LED "DC OK" / failure contact "DC OK" / Red LED "Overload"		
Alarm contact threshold	<21.6 Vdc	<43.2 Vdc	<64.8 Vdc
Parallel connection	possible	possible	possible
Redundant parallel connection	possible with external ORing diode	already fitted with internal ORing diode	already fitted with internal ORing diode

## GENERAL TECHNICAL DATA

Efficiency (Uin 400 / 500 Vac)	>92% / >92%	>92% / >92%	>94% / >94%
Dissipated power (Uin 400 / 500 Vac)	80 W / 80 W	80 W / 80 W	60 W / 60 W
Operating temperature range	-20...+60°C, with derating over 45°C / thermal protection (3)		
Input/output isolation	3 kVac / 60 s SELV output (5)		
Input/PE isolation	2 kVac / 60 s		
Output/PE isolation	0.5 kVac / 60 s		
Safety standards	EN 60950-1+A1+A2+A12, UL 508		
Electromagnetic compatibility	EN61000-6-1, EN61000-6-2, EN61000-6-3, EN61000-6-4		
MTBF at 25°C and nominal ratings	>500'000 h according to SN 29500 / >150'000 h according to MIL Std. HDBK 217F		
Overvoltage category / Pollution degree	II / 2		
Protection degree	IP 20 IEC 529, EN60529		
Connection type	6 mm² fixed screw terminal blocks		
Housing material	aluminium		
Approximate weight	1.2 kg		
Mounting information	vertical on rail, allow 10 mm spacing between adjacent components		

## MOUNTING ACCESSORIES

- Mounting rail type according to IEC60715/TH35-7.5
- Mounting rail type according to IEC60715/G32

PR/3/AC, PR/3/AC/ZB, PR/3/AS, PR/3/AS/ZB



# 3-phase switching power supply 400-500 Vac - output power 2400 W

- 3-phase input 340...550 Vac
- Short circuit, overload, over temperature and overvoltage input and output protection
- Elevated outrush current to ensure the selectivity of protections and start-up of heavy loads
- High efficiency and low consumption
- Suitable for SELV and PELV circuits



## NOTES

- The depth measurement includes rail clamp clearance.
- (2) Version made to order (not kept in stock); contact our sales office for availability.
- (3) Over 45°C apply a derating equal to approximately 40 W/°C
- (4) For this peak of power, the output voltage does not decrease more than 10% of the rated value, however the value of the current supplied by the power supply also depends on the line resistance.

## BLOCK DIAGRAM

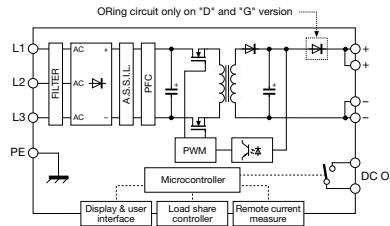

## VERSIONS

- Output 12-15-24 Vdc 100 A redundant version**
- Output 24-48 Vdc 50 A redundant version**

## Code XCSG2401C

CSG2401C (2)

## Code XCSG2401D

CSG2401D (2)

## INPUT TECHNICAL DATA

Input rated voltage	3x 400-500 Vac (range 340...550 Vac)
Frequency	47...63 Hz
Current with nominal Iout (Uin 400 / 500 Vac)	4.2 A / 3.5 A
Inrush peak current	< 2 A (with active limitation circuit)
Power factor	> 0.92
Internal protection fuse	—
External protection on AC line	circuit breaker 3x 10 A characteristic C - fuses: 3x T 10 A

## OUTPUT TECHNICAL DATA

Output rated voltage	<b>12-15-24 Vdc</b>	<b>24-48 Vdc</b>
Output adjustable range	11.5...29 Vdc	23...56 Vdc
Continuous current	<b>100 A</b> at 45°C (3)	<b>50 A</b> at 45°C (3)
Overload limiting current	150 A for >5 s with Uout >90% Un (4)	75 A for >5 s with Uout >90% Un (4)
Short circuit peak current	>150 A for 5 s (4)	>75 A for 5 s (4)
Load regulation	< 1%	< 1%
Ripple at nominal ratings	≤ 200 mVpp	≤ 200 mVpp
Hold up time (Uin 400 / 500 Vac)	>10 ms / >10 ms	>10 ms / >10 ms
Overload / short circuit protections	programmable (see side)	
Status display	Green "DC OK" LED / "DC OK" failure contact / Red "Overload" LED / LCD display (see side)	
Alarm contact threshold	programmable	
Parallel connection	possible	
Redundant parallel connection	possible	

## GENERAL TECHNICAL DATA

Efficiency (Uin 400 / 500 Vac)	>92% / >92%	>93% / >93%
Dissipated power (Uin 400 / 500 Vac)	200 W / 200 W	180 W / 180 W
Operating temperature range	-20...+60°C, with derating over 45°C / thermal protection (3)	
Input/output isolation	3 kVac / 60 s SELV output (5)	
Input/PE isolation	1.5 kVac / 60 s	
Output/PE isolation	0.5 kVac / 60 s	
Safety standards	EN 60950-1+A11, UL 508	
Electromagnetic compatibility	EN61000-6-2, EN61000-6-4	
MTBF at 25°C and nominal ratings	>500'000 h according to SN 29500 / >150'000 h according to MIL Std. HDBK 217F	
Overvoltage category / Pollution degree	II / 2	
Protection degree	IP 20 IEC529, EN60529	
Connection type	screw-clamp terminal blocks 4 and 6 mm²	
Housing material	aluminium	
Approximate weight	2.8 Kg	
Mounting information	vertical on rail, allow 60 mm spacing between adjacent components	

## MOUNTING ACCESSORIES

- Mounting rail type according to IEC60715/TH35-7.5
- Mounting rail type according to IEC60715/G32

**PR/3/AC, PR/3/AC/ZB, PR/3/AS, PR/3/AS/ZB**

## APPLICATIONS

Series CSG2401 has an internal microprocessor that controls the many functions of the power supply, which can be programmed thanks to a user-friendly menu activated by 4 buttons on the front and shown on the front display.

**Front display:** during normal operation, this shows the output voltage value and current used by the load; during programming, it allows for the choice of the various functions available.

**Input protection:** the input circuit has been designed to avoid the most common problems seen in 3-phase networks. It therefore has:

- 1) a PFC circuit failure (latched shutdown) circuit
- 2) a system for controlling lack of phase that automatically reduces output power
- 3) an auto-restart switch-off system in the event of overvoltage and undervoltage

**Output protection:** limit current can be selected as between 10% and 100% of rated current; protection type against overload and short circuit can be chosen from:

- 1) Hiccup auto reset with limit current, equal to 150% of rated current and ON/OFF time can be altered;
- 2) constant power

**Output signals:** in addition to the "DC OK" and "FAULT" LEDs, the device also has:

- 1) an analogue signal 0...10V or 4...20mA that provides an indication of current used by the load
- 2) a programmable alarm contact able to signal and record the exceeding of the various limits to a memory: output voltage, input current, output overload, over temperature and other parameters that can be defined by programming.

**Additional functions:**

- 1) Battery charger: the acid lead battery charging function can be selected;
- 2) Remote sensing (sense): this allows for the monitoring and compensation of voltage drops on long power supply lines
- 3) The power supply can be switched off and disabled from a remote position
- 4) Auxiliary voltage: auxiliary 12 Vdc is also available, regardless of the main output voltage status
- 5) Temperature control: by connecting an external sensor (NTC), the battery charge temperature can be controlled.
- 6) Communication port: by means of an RS232 communication device the power supply can be piloted and monitored from a remote position.

# 3-phase switching power supply 400-500 Vac - output power 2400 W

- 3-phase input 340...550 Vac
- Short circuit, overload, over temperature and overvoltage input and output protection
- Elevated outrush current to ensure the selectivity of protections and start-up of heavy loads
- High efficiency and low consumption
- Suitable for PELV circuits



## NOTES

- The depth measurement includes rail clamp clearance.  
 With DC input, outrush current is reduced by 30%  
 (2) Version made to order (not kept in stock); contact our sales office for availability.  
 (3) Over 45°C apply a derating equal to approximately 40 W/°C  
 (4) For this peak of power, the output voltage does not decrease more than 10% of the rated value, however the value of the current supplied by the power supply also depends on the line resistance.  
 (5) G and R versions not suitable for SELV applications

## BLOCK DIAGRAM

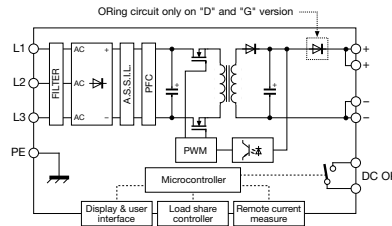

## VERSIONS

- Output 72 Vdc 33 A redundant version (5)
- Output 100-110-170 Vdc 14 A redundant version (5)

## INPUT TECHNICAL DATA

Input rated voltage	3x 400-500 Vac (range 340...550 Vac)
Frequency	47...63 Hz
Current with nominal Iout (Uin 400 / 500 Vac)	4.2 A / 3.5 A
Inrush peak current	< 2 A (with active limitation circuit)
Power factor	> 0.92
Internal protection fuse	—
External protection on AC line	circuit breaker 3x 10 A characteristic C - fuses: 3x T 10 A

## OUTPUT TECHNICAL DATA

Output rated voltage	72 Vdc	100-110-170 Vdc
Output adjustable range	50...87 Vdc	88...175 Vdc
Continuous current	33 A at 45°C (3)	14 A at 45°C (3)
Overload limiting current	50 A for >5 s with Uout >90% Un (4)	21 A for >5 s with Uout >90% Un (4)
Short circuit peak current	>50 A for 5 s (4)	>21 A for 5 s (4)
Load regulation	< 1%	< 1%
Ripple at nominal ratings	≤ 200 mVpp	≤ 200 mVpp
Hold up time (Uin 400 / 500 Vac)	>10 ms / >10 ms	>10 ms / >10 ms
Overload / short circuit protections	programmable (see side)	programmable (see side)
Status display	Green "DC OK" LED / "DC OK" failure contact / Red "Overload" LED / LCD display (see side)	programmable
Alarm contact threshold	programmable	possible
Parallel connection	possible	possible
Redundant parallel connection	possible	possible

## GENERAL TECHNICAL DATA

Efficiency (Uin 400 / 500 Vac)	>92% / >92%	>92% / >92%
Dissipated power (Uin 400 / 500 Vac)	200 W / 200 W	200 W / 200 W
Operating temperature range	-20...+60°C, with derating over 45°C / thermal protection (3)	
Input/output isolation	3 kVac / 60 s SELV output (5)	
Input/PE isolation	1.5 kVac / 60 s	
Output/PE isolation	0.5 kVac / 60 s	
Safety standards	EN 60950-1+A11, UL 508	
Electromagnetic compatibility	EN61000-6-2, EN61000-6-4	
MTBF at 25°C and nominal ratings	>500'000 h according to SN 29500 / >150'000 h according to MIL Std. HDBK 217F	
Overvoltage category / Pollution degree	II / 2	
Protection degree	IP 20 IEC529, EN60529	
Connection type	screw-clamp terminal blocks 4 and 6 mm²	
Housing material	aluminium	
Approximate weight	2.8 Kg	
Mounting information	vertical on rail, allow 60 mm spacing between adjacent components	

## MOUNTING ACCESSORIES

- Mounting rail type according to IEC60715/TH35-7.5
- Mounting rail type according to IEC60715/G32

Code XCSG2401G	Code XCSG2401R
CSG2401G (5) (2)	CSG2401R (5) (2)

## APPLICATIONS

Series CSG2401 has an internal microprocessor that controls the many functions of the power supply, which can be programmed thanks to a user-friendly menu activated by 4 buttons on the front and shown on the front display.

**Front display:** during normal operation, this shows the output voltage value and current used by the load; during programming, it allows for the choice of the various functions available.

**Input protection:** the input circuit has been designed to avoid the most common problems seen in 3-phase networks. It therefore has:

- 1) a PFC circuit failure (latched shutdown) circuit
- 2) a system for controlling lack of phase that automatically reduces output power
- 3) an auto-restart switch-off system in the event of overvoltage and undervoltage

**Output protection:** limit current can be selected as between 10% and 100% of rated current; protection type against overload and short circuit can be chosen from:

- 1) hiccup auto reset with limit current, equal to 150% of rated current and ON/OFF time can be altered;
- 2) Constant power

**Output signals:** in addition to the "DC OK" and "FAULT" LEDs, the device also has:

- 1) an analogue signal 0...10V or 4...20mA that provides an indication of current used by the load
- 2) a programmable alarm contact able to signal and record the exceeding of the various limits to a memory: output voltage, input current, output overload, over temperature and other parameters that can be defined by programming.

**Additional functions:**

- 1) Battery charger: the acid lead battery charging function can be selected;
- 2) Remote sensing (sense): this allows for the monitoring and compensation of voltage drops on long power supply lines
- 3) The power supply can be switched off and disabled from a remote position
- 4) Auxiliary voltage: auxiliary 12 Vdc is also available, regardless of the main output voltage status
- 5) Temperature control: by connecting an external sensor (NTC), the battery charge temperature can be controlled.
- 6) Communication port: by means of an RS232 communication device the power supply can be piloted and monitored from a remote position.

PR/3/AC, PR/3/AC/ZB, PR/3/AS, PR/3/AS/ZB

# DC/DC Insulated converters output power 120 W

- DC wide range input
- Short-circuit, overload, overtemperature protection
- Extremely small size

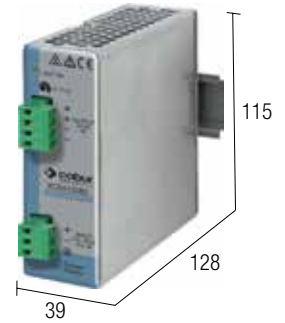

## NOTES

The depth measurement includes terminal block and rail clamp clearance.

- (1) Inrush current measured at  $U_n$  with battery power supply; peak current varies according to the internal impedance of the current source and the resistance of the connections.
- (2) The capacitors between phase and neutral, requires that the isolation tests are carried out in DC in accordance with EN60950.
- (3) Version made to order (not kept in stock); contact our sales office for availability.

## BLOCK DIAGRAM

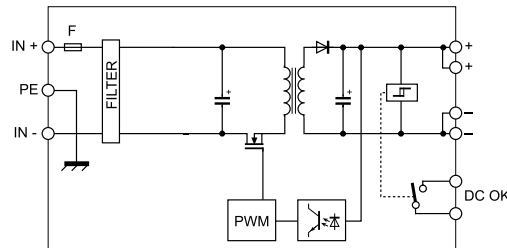

## VERSIONS

**12 Vdc / 24 Vdc 5 A**  
**24 Vdc / 12 Vdc 7 A**  
**24 Vdc / 24 Vdc 5 A**  
**48 Vdc / 24 Vdc 5 A**

Code XCSA120BC	Code XCSA120CB	Code XCSA120CC	Code XCSA120DC
<b>CSA120BC (3)</b>			
	<b>CSA120CB</b>		
		<b>CSA120CC</b>	
			<b>CSA120DC</b>

## INPUT TECHNICAL DATA

Input rated voltage  
 Current with nominal lout  
 Inrush peak current  
 Power in standby  
 Internal protection fuse  
 External protection on AC line  
 Surge protection circuit

12 Vdc (range 10.5...18 Vdc)	24 Vdc (range 18...36 Vdc)	24 Vdc (range 18...36 Vdc)	48 Vdc (range 36...72 Vdc)
10 A $\pm 10\%$	5.1 A $\pm 10\%$	5.8 A $\pm 10\%$	2.8 A $\pm 10\%$
< 60A / < 2ms (1)	< 110A / < 2ms (1)	< 90A / < 2ms (1)	< 120A / < 2ms (1)
<1.5 W at 12 Vdc	<1 W at 24 Vdc	<1.5 W at 24 Vdc	<2 W at 48 Vdc
Replaceable T 20 A	Replaceable T 10 A		Replaceable T 5 A
$\geq 25$ A characteristic C	$\geq 13$ A characteristic C		$\geq 6$ A characteristic C
varistor and automatic power off at 19 Vdc	varistor and automatic switch-off at 38 Vdc		varistor and automatic switch-off at 76 Vdc

## OUTPUT TECHNICAL DATA

Output rated voltage  
 Output adjustable range  
 Continuous current  
 Overload limiting current  
 Short circuit peak current  
 Load regulation  
 Ripple at nominal ratings  
 Hold Up time at In  
 Overload / short circuit protections  
 Status display  
 Alarm contact threshold  
 Parallel connection  
 Redundant parallel connection

24 Vdc	12...15 Vdc	24 Vdc	24 Vdc
22.5...27.5 Vdc	12...15 Vdc	22.5...27.5 Vdc	22.5...27.5 Vdc
<b>5 A</b> at 24 Vdc	<b>7 A</b> at 12 Vdc	<b>5 A</b> at 24 Vdc	5A at 24 Vdc
6.5 A	9.1 A	6.5 A	6.5 A
12 A for 300 ms	15 A for 300 ms	12 A for 300 ms	13 A for 300 ms
<0.5%	<0.5%	<0.5%	<0.5%
$\leq 100$ mVpp	$\leq 100$ mVpp	$\leq 150$ mVpp	$\leq 200$ mVpp
>1 ms	>2 ms		4.5 ms
hiccup at the overload limit with auto reset/thermal protection			
Green LED "DC OK"			
—			
possible			
possible with external ORing diode			

## GENERAL TECHNICAL DATA

Efficiency ( $U_{in}$  110 Vdc)  
 Dissipated power ( $U_{in}$  110 Vdc)  
 Operating temperature range  
 Input/output isolation  
 Input/PE isolation  
 Output/PE isolation  
 Safety standards  
 Electromagnetic compatibility  
 MTBF at 25°C and nominal ratings  
 Overvoltage category / Pollution degree  
 Protection degree  
 Connection type  
 Housing material  
 Approximate weight  
 Mounting information

> 83%	>85%	>87%	>90%
<25 W	<17 W	<18 W	<13 W
-20...+50°C			
2.1 kVdc / 60s (2)			
1.41 kVdc / 60s (2)			
0.75 kVdc / 60s (2)			
EN 60950-1+A1+A2+A12, UL 508			
EN61000-6-1, EN61000-6-2, EN61000-6-3, EN61000-6-4			
>500'000 h according to SN 29500 / >150'000 h according to MIL Std. HDBK 217F			
II / 2			
IP 20 IEC 529, EN60529			
2.5 mm <sup>2</sup> removable screw terminal blocks			
aluminium			
550 g			
vertical on rail, allow 10 mm spacing between adjacent components			

## MOUNTING ACCESSORIES

Mounting rail type according to IEC60715/TH35-7.5  
 Mounting rail type according to IEC60715/G32

**PR/3/AC, PR/3/AC/ZB, PR/3/AS, PR/3/AS/ZB**



# DC/DC Insulated converters output power 240 W

- DC wide range input
- Short-circuit, overload, overtemperature protection
- Internal diode for the redundant parallel connection
- Extremely small size

**NOTE:**  
CSD, CSF30, CSF85 and CSF120 series power supplies  
can also be filtered at 110 Vdc.

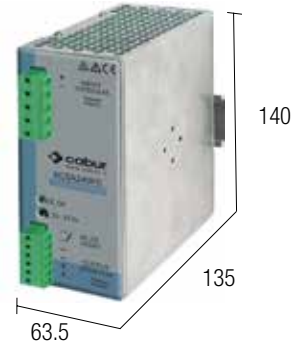

## NOTES

The depth measurement includes terminal block and rail clamp clearance.

- (1) Inrush current measured at  $U_{in}$  with battery power supply; peak current varies according to the internal impedance of the current source and the resistance of the connections.
- (2) Over 50°C apply a derating -6 W/°C, max 60°C
- (3) The capacitors between phase and neutral, requires that the isolation tests are carried out in DC in accordance with EN60950.

## BLOCK DIAGRAM

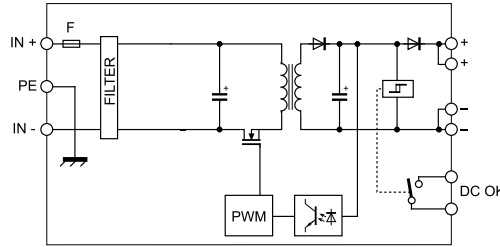

## VERSIONS

- 110 Vdc / 24 Vdc 10 A
- 110 Vdc / 24 Vdc 10 A redundant

## Code XCSA240FC

### CSA240FC

## INPUT TECHNICAL DATA

- Input rated voltage
- Current with nominal lout
- Inrush peak current
- Power in standby
- Internal protection fuse
- External protection on AC line
- Surge protection circuit

- 110 Vdc (range 100...130 Vdc)
- 2.4 A  $\pm 10\%$
- < 150A / < 2ms (1)
- < 3.4 W at 110 Vdc
- Replaceable T 5 A
- $\geq 6$  A characteristic C varistor and automatic switch-off at 136 Vdc

## OUTPUT TECHNICAL DATA

- Output rated voltage
- Output adjustable range
- Continuous current
- Overload limiting current
- Short circuit peak current
- Load regulation
- Ripple at nominal ratings
- Hold up time at  $I_n$  ( $U_{in}$  110 Vdc)
- Overload / short circuit protections
- Status display
- Alarm contact threshold
- Parallel connection
- Redundant parallel connection

- 24 Vdc
- 22.7...27 Vdc
- 10 A at 50°C (2)
- 15 A
- 21 A for 300 ms
- < 1.5%
- $\leq 100$  mVpp
- > 4 ms
- hiccup at the overload limit with auto reset/thermal protection
- Green LED "DC OK" / failure contact "DC OK" / Red LED "Overload"
- possible
- already fitted with internal ORing diode

## GENERAL TECHNICAL DATA

- Efficiency ( $U_{in}$  110 Vdc)
- Dissipated power ( $U_{in}$  110 Vdc)
- Operating temperature range
- Input/output isolation
- Input/PE isolation
- Output/PE isolation
- Safety standards
- Electromagnetic compatibility
- MTBF at 25°C and nominal ratings
- Overvoltage category / Pollution degree
- Protection degree
- Connection type
- Housing material
- Approximate weight
- Mounting information

- > 89%
- < 28 W
- 20...+60°C, with derating over 50°C (2)
- 2.1 kVdc / 60s (3)
- 1.41 kVdc / 60s (3)
- 0.75 kVdc / 60s (3)
- EN 60950-1+A1+A2+A12
- EN61000-6-2, EN61000-6-4
- > 500'000 h according to SN 29500 / > 150'000 h according to MIL Std. HDBK 217F
- II / 2
- IP 20 IEC 529, EN60529
- 2.5 mm<sup>2</sup> removable screw terminal blocks
- aluminium
- 800 g
- vertical on rail, allow 10 mm spacing between adjacent components

## MOUNTING ACCESSORIES

- Mounting rail type according to IEC60715/TH35-7.5
- Mounting rail type according to IEC60715/G32

### PR/3/AC, PR/3/AC/ZB, PR/3/AS, PR/3/AS/ZB

# Adjustable stabilised linear power supply 24 Vac

- 1.2...24 Vdc adjustable output voltage
- 1.5 and 5 A output current
- Short-circuit, overload, overtemperature protection

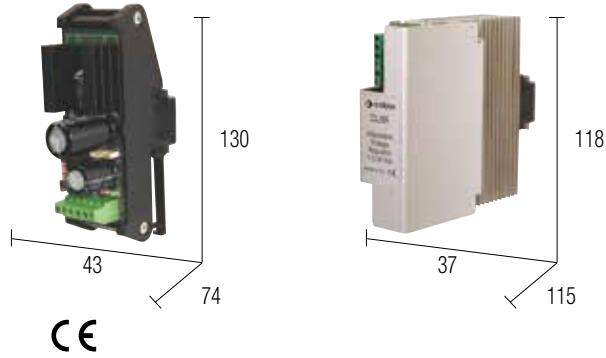

## NOTES

The depth measurement includes terminal block and rail clamp clearance.

(1) See applications.

## BLOCK DIAGRAM

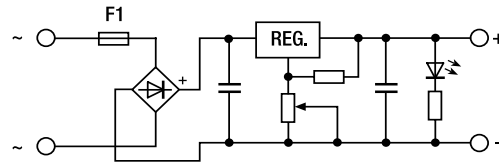

## VERSIONS

Output 1.2 A  
Output 5 A

## INPUT TECHNICAL DATA

Input rated voltage  
Frequency  
Current with nominal Iout  
Internal protection fuse  
External protection on AC line

## OUTPUT TECHNICAL DATA

Output rated voltage  
Output adjustable range  
Continuous current  
Overload limiting current  
Load regulation  
Ripple at nominal ratings  
Hold Up time at In  
Overload / short circuit protections  
Status display

## GENERAL TECHNICAL DATA

Operating temperature range  
Input/output isolation  
Input/PE isolation  
Output/PE isolation  
Reference Standards  
Electromagnetic compatibility  
MTBF at 25°C and nominal ratings  
Overvoltage category / Pollution degree  
Protection degree  
Connection type  
Housing material  
Approximate weight  
Mounting information

## Code XCL1R

CL1R

2.5 A

Replaceable T 3 A  
MCB: 4 A characteristic C - fuse T 4 A

1.2...24 Vdc

(see Table 1 and Table 2)  
0.3...1.5 A (see Table 2)

< 1%

< 50 mVpp at 24 Vac  
>20 ms

at constant current, limit current, with automatic recovery/thermal protection  
Green LED "DC OK"

-20...+45°C / thermal protection (1)

not insulated

0.5 kVac / 60 s

0.5 kVac / 60 s

IEC 664-1, DIN VDE

EN50081-1, EN61000-6-4

>500'000 h according to SN 29500 / >150'000 h according to MIL Std. HDBK 217F II / 2

IP 00 IEC 529, EN60529

2.5 mm<sup>2</sup> fixed screw terminal blocks

UL94V-0 plastic

120 g

aluminium

350 g

vertical on rail, allow 20 mm spacing between adjacent components

## Code XCL5R

CL5R

6 A

Replaceable T 10 A  
MCB: 10 A characteristic C - T 10 A fuse

1.2...24 Vdc

(see Table 1 and Table 2)  
0.8...5 A (see Table 2)

## APPLICATIONS

Cabur CL-R series power supplies are linear stabilised with adjustable output, capable of satisfying all small load power needs with non-standard voltages at an extremely affordable cost.

They can be rail mounted in any position as long as sufficient space is left for the free circulation of air for cooling, while model CL1R has a degree of protection IP00, meaning it is to be used inside a protected container.

Even where the power supply is protected against overcurrents, it is advised to follow the nominal data indicated in the tables below.

(1) **CL1R** and **CL5R** provide the nominal performances if combined with the secondary voltages indicated in **Tab. 1**; with a secondary voltage of 24...27 Vac, the maximum obtainable current at output voltages adjusted to values below 24 Vdc is indicated in **Tab. 2**; to stabilise the output voltage and reduce ripple at full load, linear power supplies must be powered with an input voltage that exceeds the output voltage, whereas if they are powered at 24 Vac, with an output adjusted to 24 Vdc and maximum current absorption, the ripple increases and the stability of the output voltage to load variations and  $\pm 10\%$  network variations drops; voltages above 27 Vac cause significant heating, triggering the thermal protection and reducing the current supplied.

Products are supplied with a default voltage of 24 Vdc at the output and 26 Vac at the input.

## MOUNTING ACCESSORIES

Mounting rail type according to IEC60715/TH35-7.5  
Mounting rail type according to IEC60715/G32

PR/3/AC, PR/3/AC/ZB, PR/3/AS, PR/3/AS/ZB

PR/DIN/AC, PR/DIN/AS, PR/DIN/AL

INPUT (Vac)	Uout max (Vdc)	Iout max (A) XCL1R	Iout max (A) XCL5R
24...27	24	1.5	5
16...18	15	1.5	5
14...16	12	1.5	5
12...14	10	1.5	5
12	9	1.5	5
9	5	1.5	5

Table 1 (see explanation to the side)

INPUT (Vac)	Uout max (Vdc)	Iout max (A) XCL1R	Iout max (A) XCL5R
24	24	1.5	5
24	15	0.8	2.5
24	12	0.7	2
24	10	0.5	1.5
24	9	0.45	1.3
24	5	0.3	0.8

Table 2 (see side explanation)

# Filtered power supply without transformer and with non-stabilised output

- Rail mounting
- For correcting voltages from 6 Vac to 20 Vac
- Output 1.41 times the input voltage

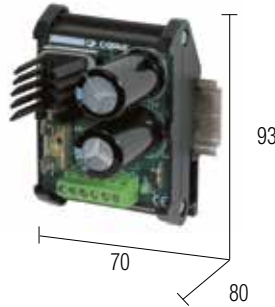

## NOTES

- (2) Version made to order (not kept in stock); for information contact our sales office.
- (3) Capable of operating with an input voltage of 6 Vac min. to 30 Vac max.; output voltage is not stabilised and varies depending on the load and on variations in the input voltage supplied by the transformer.
- (4) Protected from overcurrent with integrated input fuse (except AR1); it is advisable to protect the output line wires with fuses sized according to the load and wire currents.

## BLOCK DIAGRAM

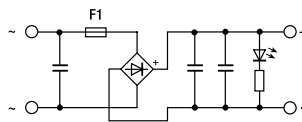

## VERSIONS

Output 6 A

### INPUT TECHNICAL DATA

- Input rated voltage
- Frequency
- Current with nominal lout
- Internal protection fuse
- External protection on AC line

### OUTPUT TECHNICAL DATA

- Output voltage (without load)
- Output voltage (at full load)
- Continuous current
- Overload limiting current
- Load regulation
- Ripple at nominal ratings
- Hold Up time at In
- Overload / short circuit protections
- Status display
- Parallel connection
- Redundant parallel connection

### GENERAL TECHNICAL DATA

- Operating temperature range
- Input/output isolation
- Input/PE isolation
- Output/PE isolation
- Reference Standards
- MTBF at 25°C and nominal ratings
- Overvoltage category / Pollution degree
- Protection degree
- Connection type
- Housing material
- Approximate weight
- Mounting information

### MOUNTING ACCESSORIES

- Mounting rail type according to IEC60715/TH35-7.5
- Mounting rail type according to IEC60715/G32

## Code XAR6

AR6

6...20 Vac

50...60 Hz

7.2 A at 20 Vac

Replaceable T 8 A

MCB: 10 A characteristic C - T 10 A fuse

$U_{out} = (U_{in} \times 1.41)$  (3)

$U_{out} = (U_{in} \times 1.41) - 2$  (3)

6 A at 20°C

9 A

—

≤ 10%

>20 ms

not supplied, insert external fuse (4)

Green LED "DC OK"

—

—

-20...+45°C / max 60°C

not insulated

0.5 kVac / 60 s

0.5 kVac / 60 s

IEC 664-1, DIN VDE

>500'000 h according to SN 29500 / >150'000 h according to MIL Std. HDBK 217F

II / 2

IP 00 IEC 529, EN60529

2.5 mm<sup>2</sup> fixed screw terminal blocks

UL94V-0 plastic

140 g

vertical on rail, allow 50 mm spacing between adjacent components

PR/3/AC, PR/3/AC/ZB, PR/3/AS, PR/3/AS/ZB

PR/DIN/AC, PR/DIN/AS, PR/DIN/AL

## APPLICATIONS

The rectified and filtered power supply comprises a transformer which isolates and reduces the secondary voltage from the network voltage (not supplied), a bridge rectifier and a filter capacity that convert alternating voltage into direct voltage at an SELV value of less than 60 Vdc.

The power supply is not stabilised, therefore the output voltage varies according to the power consumed by the load and to network voltage fluctuations of ±10%. The formulae described in the output technical data are used to calculate voltage at no load, 50% load and full load and to select the transformer best suited to your needs. **These power supplies are a reliable and affordable source for powering relays, contactors, solenoid valves** and loads capable of operating smoothly with a relatively high (5%) alternating waste on 24 Vdc (ripple) and strong changes in output voltage, whereas in applications in which the network is highly unstable and prone to voltage dips, **they may not be suitable for powering devices with microprocessors and memories, analogue converters or devices that require a highly stable power supply voltage.**

INPUT (Vac)	OUTPUT without load (Vdc)	OUTPUT full load (Vdc)
20	28.7	24.2
18	25.4	21.4
15	21.2	17.2
12	17	15
9	12.7	8.7
6	8.5	4.5

# Accessory for charging buffer batteries

- Battery charging
- Parallel connection of power supplies
- Suitable for power supplies up to 10 A
- Line and battery safety fuses
- Flyback diode
- Load current limiting resistor

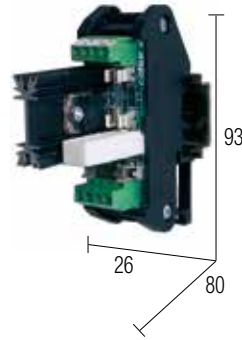

## NOTES

The depth measurement includes rail clamp clearance.

- (1) The load current may vary depending on the battery type and its charge status:
- approx. 0.5A max at 12Vdc
  - approx. 1A max at 24Vdc
- (2) The device does not prevent deep discharge of the battery, which occurs when a voltage of 0 to 60% of the nominal voltage is read at its terminals; deep discharge drastically reduces the life of the battery.

## BLOCK DIAGRAM

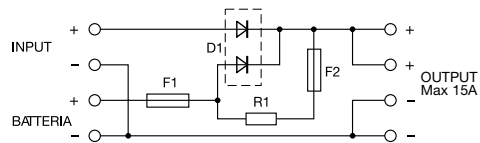

## VERSIONS

## Code XCSBC

CSBC

## APPLICATIONS

### 1. Battery charger

This module enables Cabur power supplies to charge a battery while simultaneously powering the load. The diodes effectively block the power supply from the battery, the resistor limits the load current to prevent power supply safety cut-off and prolonging the life of the battery, and fuse F1 protects the battery in the event of a short-circuit on the load. The connection occurs as shown below.

### 2. Placing power supplies in parallel

This module can be used to put two power supplies without a blocking diode in parallel, eliminating the need for fuse F2 in series with the charging current limiting resistor. The connection occurs as shown below.

## GENERAL TECHNICAL DATA

Power supply input voltage	6...30 Vdc
Power supply nominal current	> 3 A
Nominal load voltage	6...29.5 Vdc
Maximum load current	10 A
Charging current	(1)
Battery disconnection voltage	function not present
IN/OUT voltage drop	0.5 V
Battery safety fuse	F1 = T 6.3 A / F2 = T 1 A
Protections	short-circuit / battery overload (2)
Alarm signal	—
Operating temperature range	-10...+50°C
Reference Standards	IEC 664-1, DIN VDE
Overvoltage category / Pollution degree	II / 2
Protection degree	IP 20 IEC 529, EN60529
Connection type	2.5 mm <sup>2</sup> fixed screw terminal blocks
Housing material	UL94V-0 plastic
Approximate weight	80 g
Mounting information	vertical on rail, side by side

Power supply input voltage	6...30 Vdc
Power supply nominal current	> 3 A
Nominal load voltage	6...29.5 Vdc
Maximum load current	10 A
Charging current	(1)
Battery disconnection voltage	function not present
IN/OUT voltage drop	0.5 V
Battery safety fuse	F1 = T 6.3 A / F2 = T 1 A
Protections	short-circuit / battery overload (2)
Alarm signal	—
Operating temperature range	-10...+50°C
Reference Standards	IEC 664-1, DIN VDE
Overvoltage category / Pollution degree	II / 2
Protection degree	IP 20 IEC 529, EN60529
Connection type	2.5 mm <sup>2</sup> fixed screw terminal blocks
Housing material	UL94V-0 plastic
Approximate weight	80 g
Mounting information	vertical on rail, side by side

## MOUNTING ACCESSORIES

Mounting rail type according to IEC60715/TH35-7.5  
Mounting rail type according to IEC60715/G32

PR/3/AC, PR/3/AC/ZB, PR/3/AS, PR/3/AS/ZB  
PR/DIN/AC, PR/DIN/AS, PR/DIN/AL

### 1. Battery charger

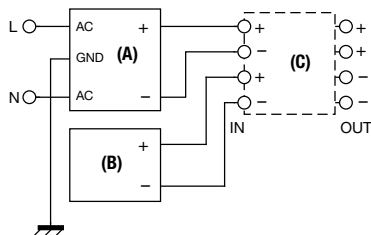

- (A) Power supply
- (B) Battery
- (C) CSBC

### 2. Placing power supplies in parallel

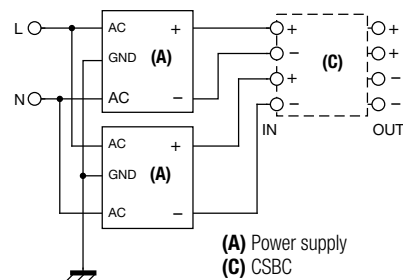

- (A) Power supply
- (C) CSBC

# Accessory for charging and checking buffer batteries

- Suitable for power supplies with adjustable output
- Suitable for lead batteries
- Supplies power to load and battery simultaneously
- Battery safety fuse
- Battery full discharge protection
- LED status indicator and alarm relay



Item available until supplies last; will be replaced by XCSU240S



## NOTES

The depth measurement includes rail clamp clearance.

## BLOCK DIAGRAM

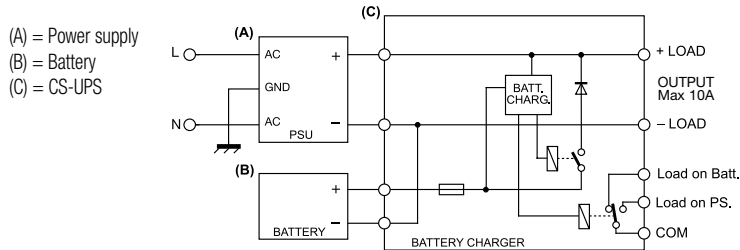

## VERSIONS

Output 24 Vdc  
Output 12 Vdc

## GENERAL TECHNICAL DATA

Power supply input voltage	
Power supply nominal current	
Nominal load voltage	
Maximum load current	
Charging current	
Battery disconnection voltage	
IN/OUT voltage drop	
Battery safety fuse	
Protections	
Alarm signals	Power supply OK: Battery OK Battery LOW Load OK Green LED
Operating temperature range	
Reference Standards	
Oversvoltage category / Pollution degree	
Protection degree	
Connection type	
Housing material	
Approximate weight	
Mounting information	

Code XCSUPS1	Code XCSUPS2
<b>CS-UPS1</b>	<b>CS-UPS2</b>
26...28.5 Vdc	12...15 Vdc
≥ 3 A	≥ 3 A
<b>26...28 Vdc</b>	<b>10...15 Vdc</b>
<b>10 A</b>	<b>10 A</b>
Selectable 2 A or 4 A	Selectable 2 A or 4 A
≤ 18 Vdc ±0.5V	≤ 9.2 Vdc ±0.5V
0.4 V	
T 15 A 42 V blade type	
Reverse polarity, short-circuit, battery overload, battery deep discharge	
SPDT 24 V / 1 A	
Green LED	
Red LED	
Yellow LED	
Green LED	
-10...+50°C	
IEC 664-1, DIN VDE	
II / 2	
IP 20 IEC 529, EN60529	
2.5 mm <sup>2</sup> removable screw terminal blocks	
aluminium	
300 g	
vertical on rail, side by side	
<b>PR/3/AC, PR/3/AC/ZB, PR/3/AS, PR/3/AS/ZB</b>	

## MOUNTING ACCESSORIES

Mounting rail type according to IEC60715/TH35-7.5  
Mounting rail type according to IEC60715/G32

## APPLICATIONS

All power supplies with adjustable output to at least +15% of the nominal voltage can be used for charging lead acid batteries to be used as back-up power, offering regulation and control in the event of a blackout or local network failure. The circuit in the CS-UPS1 module regulates and controls battery charging current and can be set to two maximum charging currents: 2 A or 4 A; it also disconnects the load from the battery if the voltage at full load drops below the limit to prevent deep battery discharge, which occurs when a voltage of 0 to 60% of the nominal voltage is read at its terminals; deep discharge drastically reduces the life of the battery. The module is also equipped with a fuse that protects the battery and connecting wires to the overcurrent module. The following alarm indicators are available:

**PS OK:** Green LED, indicates that the network power supply is operational and is powering the load, while the battery is kept charged.

**LOAD OK:** Yellow LED, indicates that the CS-UPS terminal blocks are showing a power that is capable of supplying the load.

**BATT. OK:** Green LED, with the power supply switched off or disconnected, indicates that the battery is connected and is charging.

**BATT. LOW:** Red LED, indicates that the battery is discharged.

**REVERSE BATTERY:** Red LED, indicates that the battery is connected with reversed polarity.

**Failure contact:** this is a single exchange 1 A / 24 V relay which is triggered when the power to the load switches from the power supply to the battery. The remote warning indicates the system status even when the power supply switches off due to an internal panel malfunction and indicates that the battery was activated due to a local fault not immediately visible to the operator, unlike a general blackout.

# Accessory for charging and checking buffer batteries



- Power supply connection, supplies energy to the load and maintains the backup battery
- Suitable for Lead-Acid, NiMH and Ni-Cd batteries
- 12 V or 24 V battery voltages with a load current of up to 5 A
- High efficiency and low consumption
- Small size

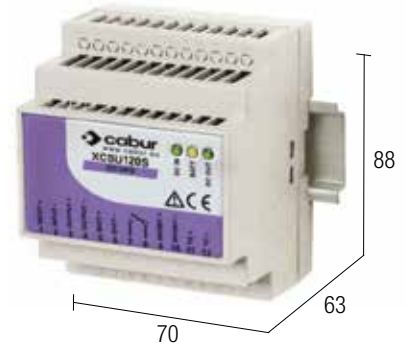

## NOTES

(1) Programmable

## BLOCK DIAGRAM

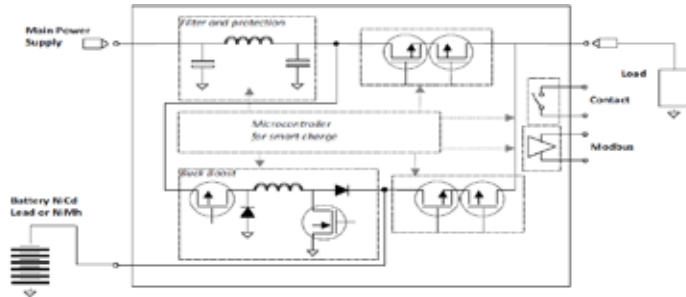

## VERSIONS

Code XCSU120S

## INPUT TECHNICAL DATA

Power supply input voltage  
Maximum input current

## OUTPUT TECHNICAL DATA

Load voltage  
Load current  
Status display

Communication

## TECHNICAL DATA BATTERIES

Battery type  
Battery nominal voltage  
Maximum load current  
Nominal capacity range  
Backup lag time  
Protections

## GENERAL TECHNICAL DATA

Efficiency  
Dissipated power  
Operating temperature range  
Input/output isolation  
Input/PE isolation  
Output/PE isolation  
Safety standards  
Electromagnetic compatibility  
MTBF at 25°C and nominal ratings  
Overvoltage category / Pollution degree  
Protection degree  
Connection type  
Housing material  
Approximate weight  
Mounting information

## MOUNTING ACCESSORIES

Mounting rail type according to IEC60715/TH35-7.5  
Mounting rail type according to IEC60715/G32

## Code XCSU120S

CSU120S

## 12-24 Vdc (range 10...16 Vdc / 20...29 Vdc)

5 A

## 12-24 Vdc (1)

5A max. to 20°C / 4A max. to 45°C  
Normal operation failure contact (Ready)  
Battery operation failure contact (Backup)  
Green LED "DC OK"  
Battery charge yellow LED / Battery supplies the charge  
RS485 - ModBus RTU

## Lead-Acid, NiMH, Ni-Cd

## 12 or 24 Vdc (1)

500 mA (1)  
1.2 ... 10Ah  
n/a  
reverse polarity/overload/deep discharge

## >90%

< 2W

-20...+60°C

-

-

-

EN60950

EN61000-6-2, EN61000-6-4

>500'000 h according to SN 29500 / >150'000 h according to MIL Std.

HDBK 217F

II / 2

IP 20 IEC 529, EN60529

2.5 mm<sup>2</sup> screw-clamp terminal blocks

aluminium

200 g

vertical on rail, allow 5 mm spacing between adjacent components

## PR/3/AC, PR/3/AC/ZB, PR/3/AS, PR/3/AS/ZB

## APPLICATIONS

**XCSU120S** is a smart battery equipped with a microprocessor to determine the most appropriate charging and monitoring algorithm to ensure battery efficiency. Using an external DC power source, XCSU120S is able to charge universal and NiCd, NiMH and lead acid batteries.

## PRODUCT FEATURES:

- Independent 12 or 24 V input, output and battery voltages (microprocessor sets the voltage to the required level)
- It is no longer necessary to increase the voltage of the power supply to allow the battery to charge, resulting in an increase of the output voltage
- The device is supplied with a default setting that can be changed with a simple ModBus connection, which can also be used to monitor functions and establish a direct connection to a PLC
- Integrated software allows you to select battery type and capacity, with the microprocessor selecting the most appropriate charging algorithm and monitoring its efficiency
- System monitoring with two available remote alarms that can be set to no network power, battery on, battery efficiency, battery overtemperature, output overload
- Programmable remote control for turning battery charging, output and alarms on/off
- Programmable on/off timer
- DIP-switch programming for most functions



# Accessory for charging and checking buffer batteries



- Power supply connection, supplies energy to the load and maintains the backup battery
- Suitable for Lead-Acid, NiMH and Ni-Cd batteries
- 12 V or 24 V battery voltages with a load current of up to 10 A
- High efficiency and low consumption
- Small size

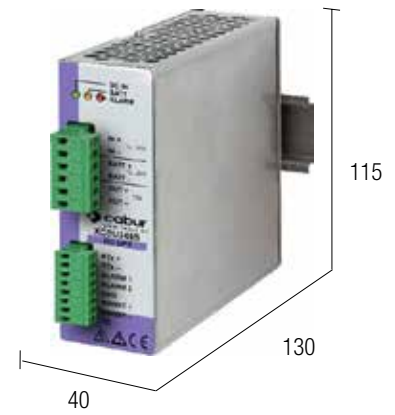

## NOTES

(1) Programmable

## BLOCK DIAGRAM

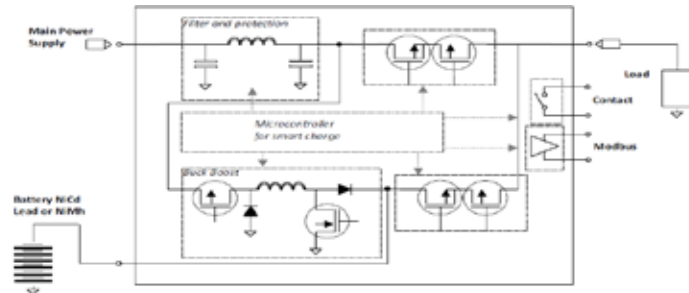

## VERSIONS

Code XCSU240S

## INPUT TECHNICAL DATA

Power supply input voltage  
Maximum input current

## OUTPUT TECHNICAL DATA

Load voltage  
Load current  
Status display

Communication

## TECHNICAL DATA BATTERIES

Battery type  
Battery nominal voltage  
Maximum load current  
Nominal capacity range  
Backup lag time  
Protections

## GENERAL TECHNICAL DATA

Efficiency  
Dissipated power  
Operating temperature range  
Input/output isolation  
Input/PE isolation  
Output/PE isolation  
Safety standards  
Electromagnetic compatibility  
MTBF at 25°C and nominal ratings  
Overvoltage category / Pollution degree  
Protection degree  
Connection type  
Housing material  
Approximate weight  
Mounting information

## MOUNTING ACCESSORIES

Mounting rail type according to IEC60715/TH35-7.5  
Mounting rail type according to IEC60715/G32

## Code XCSU240S

CSU240S

## 12-24 Vdc (range 11... 30 Vdc)

10 A

## 12-24 Vdc (1)

10A max at 20°C / 9A max at 45°C  
Normal operation failure contact (Ready)  
Battery operation failure contact (Backup)  
Green LED "DC OK"  
Battery charge yellow LED / Battery supplies the charge  
RS485 - ModBus RTU

## Lead-Acid, NiMH, Ni-Cd

## 12 or 24 Vdc (1)

1 A (1)  
1.2... 20Ah  
n/a  
reverse polarity/overload/deep discharge

## >90%

< 3W

-20... +60°C

-

-

-

EN60950

EN61000-6-2, EN61000-6-4

>500'000 h according to SN 29500 / >150'000 h according to MIL Std.

HDBK 217F

II / 2

IP 20 IEC 529, EN60529

2.5 mm<sup>2</sup> (IN/OUT/BATT) and 0.75 mm<sup>2</sup> (signal) removable screw terminal blocks

aluminium

300 g

vertical on rail, allow 5 mm spacing between adjacent components

## PR/3/AC, PR/3/AC/ZB, PR/3/AS, PR/3/AS/ZB

## APPLICATIONS

**XCSU240S** is a smart battery equipped with a microprocessor to determine the most appropriate charging and monitoring algorithm to ensure battery efficiency. Using an external DC power source, XCSU240S is able to charge NiCd, NiMH and lead acid batteries.

### PRODUCT FEATURES:

- Independent 12 or 24 V input, output and battery voltages (microprocessor sets the voltage to the required level)
- It is no longer necessary to increase the voltage of the power supply to allow the battery to charge, resulting in an increase of the output voltage
- The device is supplied with a default setting that can be changed with a simple ModBus connection, which can also be used to monitor functions and establish a direct connection to a PLC
- Integrated software allows you to select battery type and capacity, with the microprocessor selecting the most appropriate charging algorithm and monitoring its efficiency
- System monitoring with two available remote alarms that can be set to no network power, battery on, battery efficiency, battery overtemperature, output overload
- Programmable remote control for turning battery charging, output and alarms on/off
- Programmable on/off timer

# Switching power supply with integrated battery charging

- For powering loads and maintaining battery charge
- Suitable for lead batteries
- Supplies power to load and battery simultaneously
- Battery safety circuit
- Battery full discharge protection
- LED status indicator and alarm relay

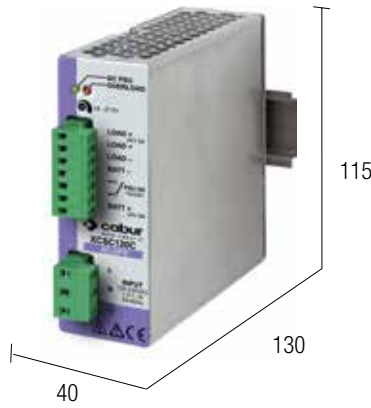

## NOTES

The depth measurement includes terminal block and rail clamp clearance.

- (2) With an input powered at 100...127 Vdc, using constant power and  $T_a > 45^\circ\text{C}$ , the outrush current is reduced by 25%
- (3) In addition to powering the load, the power supply delivers around 0.8 A for charging the battery
- (4) Over  $50^\circ\text{C}$  apply a derating  $-0.13 \text{ A}/^\circ\text{C}$ , max  $60^\circ\text{C}$

## BLOCK DIAGRAM

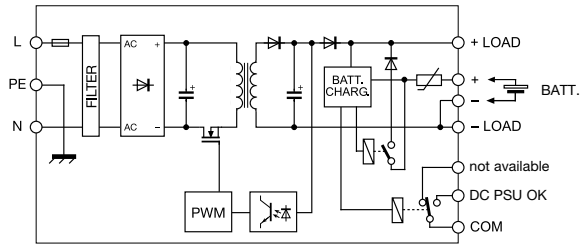

## VERSIONS

- Output 12 Vdc 5 A
- Output 24 Vdc 5 A

Code XCSC120B	Code XCSC120C
CSC120B	CSC120C

## APPLICATIONS

## INPUT TECHNICAL DATA

Input rated voltage	120–230 Vac (range 90...264 Vac / 100...370 Vdc) (2)
Frequency	47...63 Hz
Current with nominal Iout (Uin 120 / 230 Vac)	1.6 / 0.9 A
Inrush peak current	< 20 A
Power factor	> 0.6
Internal protection fuse	Replaceable T 3.15 A
External protection on AC line	circuit breaker 4 A characteristic C - fuses: T 3.15 A

Code XCSC120B	Code XCSC120C
120–230 Vac (range 90...264 Vac / 100...370 Vdc) (2)	120–230 Vac (range 90...264 Vac / 100...370 Vdc) (2)
47...63 Hz	47...63 Hz
1.6 / 0.9 A	1.9 / 1.1 A
< 20 A	< 20 A
> 0.6	> 0.6
Replaceable T 3.15 A	Replaceable T 3.15 A
circuit breaker 4 A characteristic C - fuses: T 3.15 A	circuit breaker 4 A characteristic C - fuses: T 3.15 A

## OUTPUT TECHNICAL DATA

Output voltage with power supply on	12.5...15.5 Vdc	23...27.5 Vdc
Output voltage with battery operation	12...14.4 Vdc	24...26.2 Vdc
Continuous current	5 A at 50°C (3)	5 A at 50°C (3)
Overload limiting current	>11 A for >30 s	>8 A for >30 s
Short circuit peak current	>18 A for >50 ms	>12 A for >50 ms
Load regulation	< 1%	< 1%
Ripple at nominal ratings	80 mVpp	80 mVpp
Hold up time at In (Uin 120 / 230 Vac)	>24 ms / >80 ms	>17 ms / >72 ms
Overload / short circuit protections	with power supply on: hiccup at limit current with automatic recovery with power supply off: self-resetting electronic fuse in case of battery short-circuit with power supply off: threshold relay to protect against deep battery discharge Green LED "PSU OK" / failure contact / Red LED "BATTERY" 0.8 A (suitable for sealed lead acid batteries up to 15 Ah)	

Code XCSC120B	Code XCSC120C
12.5...15.5 Vdc	23...27.5 Vdc
12...14.4 Vdc	24...26.2 Vdc
5 A at 50°C (3)	5 A at 50°C (3)
>11 A for >30 s	>8 A for >30 s
>18 A for >50 ms	>12 A for >50 ms
< 1%	< 1%
80 mVpp	80 mVpp
>24 ms / >80 ms	>17 ms / >72 ms
with power supply on: hiccup at limit current with automatic recovery with power supply off: self-resetting electronic fuse in case of battery short-circuit with power supply off: threshold relay to protect against deep battery discharge Green LED "PSU OK" / failure contact / Red LED "BATTERY" 0.8 A (suitable for sealed lead acid batteries up to 15 Ah)	

Alarm signal	
Max load current	

## GENERAL TECHNICAL DATA

Efficiency (Uin 120 / 230 Vac)	>81% / >83%	>84% / >86%
Dissipated power (Uin 120 / 230 Vac)	25 W / 22 W	22 W / 19 W
Operating temperature range	-20...+60°C, with derating over 50°C / thermal protection (4)	
Input/output isolation	1.5 kVac / 60 s SELV output	
Input/PE isolation	1.5 kVac / 60 s	
Output/PE isolation	0.5 kVac / 60 s	
Safety standards	IEC950, EN60950	
Electromagnetic compatibility	EN55011, EN61000-6-1	
MTBF at 25°C and nominal ratings	>500'000 h according to SN 29500 / >150'000 h according to MIL Std. HDBK 217F	
Overvoltage category / Pollution degree	II / 2	
Protection degree	IP 20 IEC 529 EN60529	
Connection type	2.5 mm <sup>2</sup> removable screw terminal blocks	
Housing material	aluminium	
Approximate weight	500 g	
Mounting information	vertical on rail, allow 10 mm spacing between adjacent components	

Code XCSC120B	Code XCSC120C
>81% / >83%	>84% / >86%
25 W / 22 W	22 W / 19 W
-20...+60°C, with derating over 50°C / thermal protection (4)	
1.5 kVac / 60 s SELV output	
1.5 kVac / 60 s	
0.5 kVac / 60 s	
IEC950, EN60950	
EN55011, EN61000-6-1	
>500'000 h according to SN 29500 / >150'000 h according to MIL Std. HDBK 217F	
II / 2	
IP 20 IEC 529 EN60529	
2.5 mm <sup>2</sup> removable screw terminal blocks	
aluminium	
500 g	
vertical on rail, allow 10 mm spacing between adjacent components	

## MOUNTING ACCESSORIES

- Mounting rail type according to IEC60715/TH35-7.5
- Mounting rail type according to IEC60715/G32

## PR/3/AC, PR/3/AC/ZB, PR/3/AS, PR/3/AS/ZB

# Accessory for redundant power supply connections

- Suitable for connecting non-supplied power supplies
- Compact dimensions
- 12, 24 and 48 Vdc selectable operating voltages
- 2 alarm relays
- LED power indicator

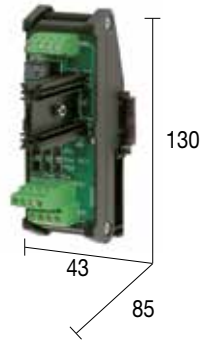

## NOTES

The depth measurement includes rail clamp clearance.

## BLOCK DIAGRAM

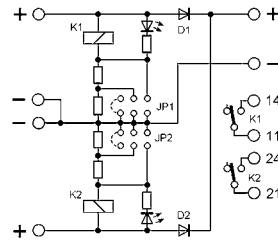

## VERSIONS

## Code XCSBD

## APPLICATIONS

CSBD

This module is used for placing two power supplies without blocking diodes in parallel; jumpers can be used to select the desired operating voltage, and each channel has a relay and an LED diode giving you a remote alarm signal in case a power supply switches off.

## GENERAL TECHNICAL DATA

Power supply input voltage	12–24–48 Vdc selectable
Power supply nominal current	15 A, max 30 A
Nominal load voltage	12–24–48 Vdc selectable
Maximum load current	15 A
IN/OUT voltage drop	0.7 V at 15 A
Protections	—
Alarm signal	2 NA contacts 2A at 230 Vac
Operating temperature range	-20...+50°C
Reference Standards	IEC 664-1, DIN VDE
Overvoltage category / Pollution degree	II / 2
Protection degree	IP 00 IEC 529, EN60529
Connection type	2.5 mm <sup>2</sup> fixed screw terminal blocks
Housing material	UL94V-0 plastic
Approximate weight	120 g
Mounting information	vertical on rail, side by side

12–24–48 Vdc selectable

15 A, max 30 A

12–24–48 Vdc selectable

15 A

0.7 V at 15 A

2 NA contacts 2A at 230 Vac

-20...+50°C

IEC 664-1, DIN VDE

II / 2

IP 00 IEC 529, EN60529

2.5 mm<sup>2</sup> fixed screw terminal blocks

UL94V-0 plastic

120 g

vertical on rail, side by side

## MOUNTING ACCESSORIES

Mounting rail type according to IEC60715/TH35-7.5

Mounting rail type according to IEC60715/G32

PR/3/AC, PR/3/AC/ZB, PR/3/AS, PR/3/AS/ZB

PR/DIN/AC, PR/DIN/AS, PR/DIN/AL

## Connection Diagram

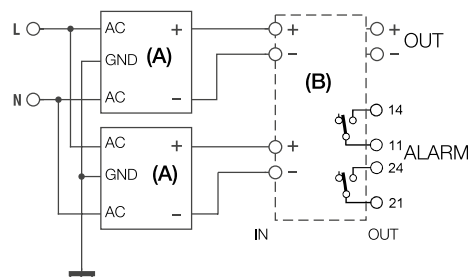

- (A) Power supply
- (B) CSBD

# Accessory for redundant power supply connections

- Suitable for connecting power supplies without ORing diodes
- 12 to 85 V load voltages with currents of up to 50 A
- CPU-controlled electronic redundancy
- Current failure and unbalance alarm
- High efficiency and low consumption
- Compact dimensions

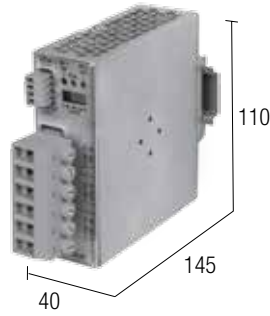

## NOTES

The depth measurement includes rail clamp clearance.

## BLOCK DIAGRAM

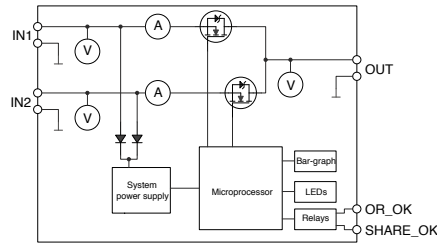

## VERSIONS

Code XCSR50U

CSR50U

## APPLICATIONS

The CSR50U is an advanced, microprocessor-controlled module used for redundant parallel connections of two DC power supplies in applications needing higher reliability than provided by common passive ORing modules with diodes to isolate the outputs of the two power supplies.

The CSR50U comes with a current measurement sensor on each input to detect the correct supply by the two power supplies and signal an alarm when the current supplied is unbalanced. An imbalance greater than 60% in the supply current is a certain indicator that one of the power supplies is failing. Detecting this situation and signalling an alarm with an SPST contact allows preventative maintenance to take place and increases the system's reliability.

In redundant systems where an imbalance in the supply is not controlled, it is not possible to monitor the correct supply of current from the two power sources. This setup permits a situation in which the current is supplied by only one power source, which then is forced to work under greater stress. Furthermore, the power source which supplies less current (or no current) may not trigger an alarm in certain conditions.

The CSR50U allows two identical power supplies to be connected for a total current output of 50 A and overall voltage from 12 to 85 Vdc.

Thanks to the ORing and isolation between the two power supplies with the microprocessor-controlled MOSFET, the power dissipated is one tenth of what redundant modules with diodes dissipate.

In addition, CSR50Us can be connected together to obtain redundancy of more than two systems.

The CSR50U provides status displays on:

- a fault or power loss in one of the two power supplies
- unbalanced current supplies greater than 60%

## GENERAL TECHNICAL DATA

Power supply input voltage
Maximum input current
Power supply input voltage
Maximum load current
IN/OUT voltage drop
Protections
Status display

<b>12...85 Vdc</b>
50 A
<b>10.8...85 Vdc</b>
<b>50 A</b> (max. 300 A peak)
0.2 V at 50 A
reverse polarity/input surge
Green LED indicating input voltage on
Red redundancy alarm LED
Redundant failure contact (24V/1A)
Current share LED bar (unbalance control)
Current share failure contact (unbalance control)
>98% (12 V / 50A)

Efficiency
Dissipated power
Operating temperature range
Input/output isolation
Input/PE isolation
Output/PE isolation
Safety standards
Electromagnetic compatibility
MTBF at 25°C and nominal ratings

10 W
-20...+50°C
0.5 kVac / 60 s
0.5 kVac / 60 s
0.5 kVac / 60 s
EN 60950
EN 61000-6-2, EN 61000-6-4
>500'000 h according to SN 29500 / >150'000 h according to MIL Std.
HDBK 217F
II / 2
IP 20 IEC 529, EN60529
16 mm <sup>2</sup> (IN/OUT) and 1.5 mm <sup>2</sup> (signal) removable screw terminal blocks
aluminium
200 g
vertical on rail, allow 10 mm spacing between adjacent components

Overvoltage category / Pollution degree
Protection degree
Connection type
Housing material
Approximate weight
Mounting information

## MOUNTING ACCESSORIES

Mounting rail type according to IEC60715/TH35-7.5
Mounting rail type according to IEC60715/G32

<b>PR/3/AC, PR/3/AC/ZB, PR/3/AS, PR/3/AS/ZB</b>
-

# MBC2K

## DC bus-powered engine braking device

**MBC2K** is a microprocessor-controlled device designed for braking DC bus-powered engines. It is activated by the surge generated by the engine when its drive requires braking. When the MBC2K is connected on the DC bus powering the engine drive (see diagram in fig. 1), the device activates automatically when the DC bus voltage exceeds the set threshold and transfers the power generated by the engine to the braking resistor, where it is dissipated. MBC2K is equipped with protection against short circuit, overload and over temperature in order to guarantee reliable operation. MBC2K can be connected to any DC bus power supply with a voltage within 24 and 100 Vdc. The simplified application is illustrated in the block diagram in Figure 1, the front view of the unit with all controls and functions is shown in Figure 2. CONNECT up to 4 units in parallel to increase the peak braking power up to 8 KW. MBC2K also has a 7-segment display and an LED for instantly viewing the DC bus voltage (accuracy +/- 1 V) which helps the user during set-up and in displaying error messages.

### MBC2K setup

The MBC2K unit must be set-up prior to operation.

The menu comprises three pages, navigable using the MENU button; The values shown can be adjusted by pressing the SET/RESET button.

- brake intervention threshold (VTH)
- brake intervention threshold hysteresis
- Master/Slave mode; for selecting single mode (Master mode) or for parallel connection of up to 4 cards (1 Master+3 Slave).

### Active protections

The MBC2K integrates active protections to ensure stable and reliable operation under normal use conditions. When it detects a fault, MBC2K turns itself off to prevent an uncontrolled flow of current through the braking resistor.

Fault status is indicated by the alarm LED flashing continuously.

And the integrated alarm relay allows the status of the module to be checked remotely.

To help the user understand which defect has occurred, an error code is shown on the 7-segment display.

### Connect up to 4 MBC2K units in parallel

Up to 4 MBC2K units can be connected in parallel to increase peak braking capacity to 8 KW. Each unit is capable of braking 2 KW of peak power, for which each unit requires its own braking resistor. To set up this configuration, MBC2K is equipped with a bus that is used to synchronise the operation of all connected units (up to 4 max.). The principle of operation is based on one MBC2K unit configured as a Master and the other MBC2K units (up to 3) configured as Slaves. The Master measures the DC bus voltage and decides when to insert the braking resistors into the circuit, sending a command on the synchronisation bus. When the Slave units connected to the synchronisation bus receive the command from the Master unit, they insert their braking resistor into the circuit. When MBC2K is configured in Slave mode, all of its protective circuits remain operational.



Figure 1 application block diagram

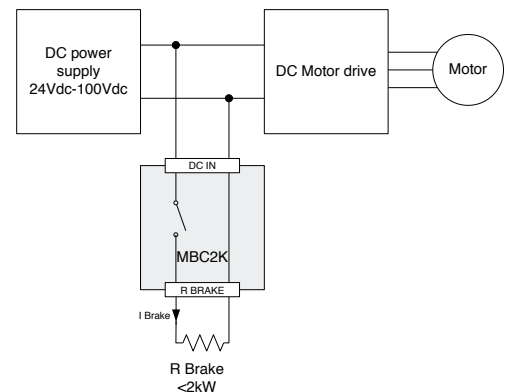

- SET / RESET:** Used to reset any errors and to change configurations in set-up mode.
- MENU:** Used to enter set-up mode and to navigate through the menu pages.
- Synchronisation bus connector:** used to connect up to 4 units in parallel.
- Braking resistor thermostat connector:** used to connect a thermostat present on the braking resistor (Klixson normally closed type is recommended; if not used, short-circuit the 2 terminals).
- Remote alarm connector:** an SPDT contact triggers the fault/malfunction signal.
- Braking resistor connector:** used to connect the external braking resistor.
- DC bus connector:** used to connect MBC2K to the 24 ... 100Vdc DC bus power supply.
- Protective earth (PE) connector:** used to connect the device to the ground protection.
- 100s display:** used to view numbers >99; e.g. if the indicator is on and the display reads "03", the measurement is 103V.
- Braking indicator:** indicates that the unit is braking the engine and supplying current to the braking R.
- 7-segment display:** when the unit is in operation, this shows the DC bus voltage (accuracy +/-1V); it is also used to display menu items and error codes.
- Alarm LED:** indicates a fault or error status.

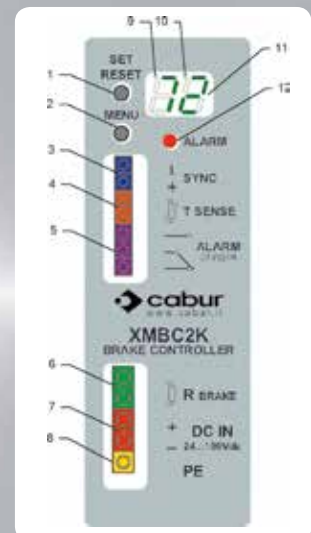
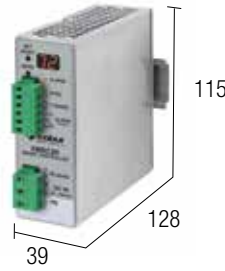

Figure 2 MBC2K - Front view

# Motor brake controller

- 20 automatically activated threshold levels
- Each module can handle a braking power of 2 kW
- Connect up to 4 cards in parallel to run a braking power of 8 kW
- Simple function programming
- Braking resistor temperature control



Item available until supplies last

## NOTES

The depth measurement includes terminal block and rail clamp clearance.

## BLOCK DIAGRAM

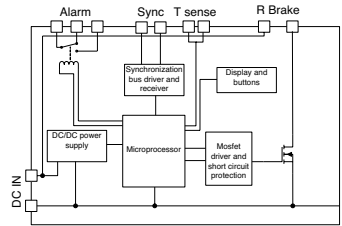

## VERSIONS

## Code XMBC2K

<b>MBC2K</b>

## APPLICATIONS

MBC2K is a microprocessor-controlled device designed for braking DC bus-powered engines. It is activated by the surge generated by the engine when its drive requires braking.

When the MBC2K is connected on the DC bus powering the engine drive (see diagram in fig. 1), the device activates automatically when the DC bus voltage exceeds the set threshold and transfers the power generated by the engine to the braking resistor, where it is dissipated. MBC2k is equipped with protection against short circuit, overload and over temperature in order to guarantee reliable operation. MBC2K can be connected to any DC bus power supply with a voltage within 24 and 100 Vdc. The simplified application is illustrated in the block diagram in Figure 1, the front view of the unit with all controls and functions is shown in Figure 2. Connect up to 4 units in parallel to increase the peak braking power up to 8 kW. MBC2K also has a 7-segment display and an LED for instantly viewing the DC bus voltage (accuracy +/- 1 V) which helps the user during set-up and in displaying error messages.

## INPUT TECHNICAL DATA

DC bus range	<b>24...100 Vdc</b>
Maximum braking current	50 A for 1 s
Operating voltage when braking	<b>27...106 V</b> , threshold adjustable in 20 steps
Threshold hysteresis	3 V or 6 V switchable
User interface	2 setup buttons (SET/RESET and MENU) Two 7-segment displays 1 LED alarm status indicator (general) 1 SPDT remote failure contact (general)
Protections	Under DC bus voltage (< 22 Vdc) Over DC bus voltage (> 110 Vdc) Braking resistor overtemperature (only where a thermostat is connected to the resistor) Module internal over temperature (temp. > 90°C) Braking resistor interrupted or not connected Short-circuit (or braking current > 80A) Overload (or braking time > 1 s)
Parallel connection	Up to 4 MBC2Ks can be connected in parallel and synchronised through the bus to obtain a total peak braking power of 8 kW (with four 2 kW braking resistors).

## Code XMBC2K

Maximum braking current	50 A for 1 s
Operating voltage when braking	<b>27...106 V</b> , threshold adjustable in 20 steps
Threshold hysteresis	3 V or 6 V switchable
User interface	2 setup buttons (SET/RESET and MENU) Two 7-segment displays 1 LED alarm status indicator (general) 1 SPDT remote failure contact (general)
Protections	Under DC bus voltage (< 22 Vdc) Over DC bus voltage (> 110 Vdc) Braking resistor overtemperature (only where a thermostat is connected to the resistor) Module internal over temperature (temp. > 90°C) Braking resistor interrupted or not connected Short-circuit (or braking current > 80A) Overload (or braking time > 1 s)
Parallel connection	Up to 4 MBC2Ks can be connected in parallel and synchronised through the bus to obtain a total peak braking power of 8 kW (with four 2 kW braking resistors).

## GENERAL TECHNICAL DATA

Dissipated power	<b>20 W</b>
Operating temperature range	0...+70°C
Input/output isolation	—
Input/PE isolation	500 Vac / 60s
Output/PE isolation	—
Safety standards	IEC950, EN60950 for SELV use up to 60 Vdc; use at higher voltages is not SELV classifiable
Electromagnetic compatibility	EN55011 Class B
Overvoltage category / Pollution degree	I / 2
Protection degree	IP 20 IEC 529, EN60529
Connection type	1.5 and 2.5 mm <sup>2</sup> removable screw terminal blocks
Housing material	aluminium
Approximate weight	200 g
Mounting information	vertical on rail, allow 10 mm spacing between adjacent components
Approximate weight	120 g
Mounting information	vertical on rail, side by side

## Code XMBC2K

Dissipated power	<b>20 W</b>
Operating temperature range	0...+70°C
Input/output isolation	—
Input/PE isolation	500 Vac / 60s
Output/PE isolation	—
Safety standards	IEC950, EN60950 for SELV use up to 60 Vdc; use at higher voltages is not SELV classifiable
Electromagnetic compatibility	EN55011 Class B
Overvoltage category / Pollution degree	I / 2
Protection degree	IP 20 IEC 529, EN60529
Connection type	1.5 and 2.5 mm <sup>2</sup> removable screw terminal blocks
Housing material	aluminium
Approximate weight	200 g
Mounting information	vertical on rail, allow 10 mm spacing between adjacent components
Approximate weight	120 g
Mounting information	vertical on rail, side by side

## MOUNTING ACCESSORIES

Mounting rail type according to IEC60715/TH35-7.5	<b>PR/3/AC, PR/3/AC/ZB, PR/3/AS, PR/3/AS/ZB</b>
Mounting rail type according to IEC60715/G32	—

## Code XMBC2K

Mounting rail type according to IEC60715/TH35-7.5	<b>PR/3/AC, PR/3/AC/ZB, PR/3/AS, PR/3/AS/ZB</b>
Mounting rail type according to IEC60715/G32	—



# Adjustable electronic overcurrent protection from 1...10 A / 24 Vdc

According to the new EN60204-1, it is **compulsory** to protect wires on SELV-PELV lines from overcurrent. The standard requires that 24 Vdc overcurrent protections intervene by cutting out the failure before the control and command 24 Vdc falls below 21.6V, cutting off power to the controls and preventing the emergency and safety features from activating.

Under EN 60204-1 and EN 61131-1 and -2, overcurrent protection on SELV/PELV lines must be capable of isolating shorts within 10 ms and hazardous overcurrents within 5 s. The use of power supplies with a high output overcurrent capacity and fast, accurate protections facilitates fault isolation before the 24 V falls below 21.6 V, leaving the controls without power.

Fuses and magneto-thermal switches inserted on 24 Vdc lines have characteristic intervention I/ts that are not suitable for isolating faults with the required speed and accuracy, while the fuses may be replaced with different types, affecting the behaviour of the protection and the safety of the system.

The proper coordination of the circuit in which the overcurrent protection is inserted must consider the total R of the line as: R connections + R wires + R protection + R residual malfunctioning load. The total R must always allow a safe current to circulate in the circuit once the protection is triggered and the protection should neither be undersized, to prevent undesirable bursts at peak load, nor oversized, to prolong its intervention t.

The entire circuit, including power supply, protection, wiring and connections, must be designed such that all overcurrents can be cut-off within 5 s before the 24 Vdc falls below 21.6 Vdc. This requirement can be met with Cabur's CSF and CSG series power supplies, designed to provide a high output overcurrent (nom. I >+50% for > 5s) and CEP System electronic overcurrent protections with an accuracy and speed far superior to magneto-thermal switches and fuses, whose trigger t is independent of ambient T and can be reset locally or remotely.

## Protection features

MGTs have two different intervention curves: Thermal and magnetic. The magnetic relay only triggers in the event of a short with different I/t curves; thermal relays all have the same intervention curve regardless of the MGT curve and in the event of an overload they behave as shown in figure 2: overload currents of  $1.13 \times I_n$  are cut in >1h, and at overcurrent  $> 1.45 \times I_n$ , the trigger occurs in several minutes. The disconnection of short-circuit currents is activated by the magnetic relay whose trigger t ranges from 0.01 to 0.1 s, and it occurs at very high currents which the power supply used may not be able to deliver: a C5 MGT used in DC has a safe trigger of > 70 A, a current which only (but not all) power supplies with a far higher nom. I, e.g. 40 A, are capable of providing, but which is not deliverable by 10 A power supplies. Using MGT as an overcurrent protection, if the power supply used has an overload I 1.2 times greater than its nominal I, disconnection will occur after 20...60 minutes, while with a current 2.5 times higher than the nominal I it will trigger after 25 s to 2 min., depending on the  $T_{amb}$ , times which are too long to guarantee stability at 24V to protect wiring and protection selectivity. In case of malfunction, until the protection triggers, the power supply remains in overload in excess of  $x 1.5 \times 5$  s and the 24 V falls below 21.6 V, leaving normal functions and particularly the safety functions without power.

## Protection selectivity

In case of an overload or short, only the malfunctioning circuit is isolated from its protection without any effects on the power to the other loads. This feature is obtained using power supplies with a high overcurrent capacity and quick and precise protections.

## CEP system – the smart current control system

CEP “recognises” overcurrent at the lowest and most precise threshold and isolates the malfunctioning circuit in the fastest possible time. For maximum flexibility of use, the CEP system allows you to set 10 trigger currents from 1 A to 10 A in 1 A increments, and has 3 intervention curves: “Rapid – Normal – Delayed” (see fig. 3).

The protection status is indicated by two LEDs and a remote alarm transistor output, while the load can be activated/deactivated using the button on the front (fig. 5) or controlled remotely by PLC. The ability to control individual channels separately is useful during installation since various components can be activated and tested individually, while in large plants, the remote control feature can be used to gradually activate the various loads, preventing multiple simultaneous overloads at system start-up. An additional safety feature is manual disconnection, with which even when reactivating the protections remotely the load will remain inactive, preventing hazardous operating conditions.



Figure 1



Figure 3



Figure 4



Figure 5

# Adjustable electronic overcurrent protection from 1...10 A / 24 Vdc

- Programmable from 1 A to 10 A in 1 A increments
- 3 programmable characteristic curves
- Remote or local ON/OFF control
- Green ON/red OFF status LED and remote signalling
- Slide contact for manual disconnection
- Sealable front cover for programming protection



- 1) sealable cover
- 2) programming current
- 3) identification tag
- 4) programming intervention curve
- 5) replacing the fuse

## NOTES

- (2) Remote control is through 24 Vdc pulses. Such pulse durations should be: = impulse > 1 s / OFF = impulse > 100 ms and < 800 ms
- (3) The 3 standard characteristic curves are shown in the diagrams; the CEP-D3 version also has a software-programmable curve.

## BLOCK DIAGRAM

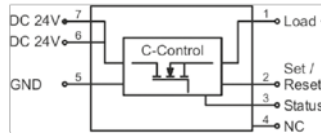

## VERSIONS

With overload indication

Code XCEPD1

Code XCEPD2

Code XCEPD3

CEP-D1

## INPUT TECHNICAL DATA

Nominal voltage
Nominal current
Max. system current
Protection
Remote ON/OFF control

24 Vdc (range 18...32 Vdc)
10 A DC max
40 A DC with CEP-RCC distribution bar
internal electronic reverse polarity
external 24 Vdc pulse

## OUTPUT TECHNICAL DATA

Nominal voltage
Min./max. current
Default trip curves
Max. connectable output capacity
Status indicator
Status display

24 Vdc (voltage drop <170 mV at Un / In)
1...10 A DC programmable in 1 A increments
slow, medium and fast
10,000 µF
Green LED: constant = OK, flashing = lout at 90% of nominal, red LED: constant = output manually switched off, flashing slowly = overcurrent, flashing quickly = error transistor for overload detection

## GENERAL TECHNICAL DATA

Operating temperature range
Input/output isolation
Protection degree
Reference Standards
Connection type
Housing material
Approximate weight
Mounting information

-25...+60°C, derating Imax. 8 A over 40°C
3 kVac / 60 s SELV output
IP 20 IEC 529, EN60529
EN60950-1, EN61131-1, EN61131-2, EN60898, EN60947-4-1, EN50081
0.25...2.5 mm² fixed-clamp spring terminal blocks
PA 6.6 (UL94V-0, NFF I2, F2)
120 g
vertical or horizontal on rail, side-by-side, use of end brackets advised

## MOUNTING ACCESSORIES

Mounting rail type according to IEC60715/TH35-7.5
Mounting rail type according to IEC60715/G32
Power supply kit (terminal block + closure)
Distribution bar
Isolating distribution bar cover
Cross connection bridge
Identification tag

PR/3/AC, PR/3/AG/ZB, PR/3/AS, PR/3/AS/ZB
CEP-SS (code XCEPSS)
CEP-RCC (code XCEPRCC)
CEP-RCP (code XCEPRCP)
CEP-BCR (code XCEPBCR) (8 poles)
CEP-BCB (code XCEPBCB) (8 poles)
CEP-MTW (code XCEPMTW) (table with 50 tags)

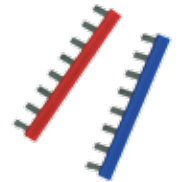

CEP-BCR and CEP-BCB



CEP-MTW



CEP-SS

Characteristic curve:  
1) fast  
2) medium  
3) slow

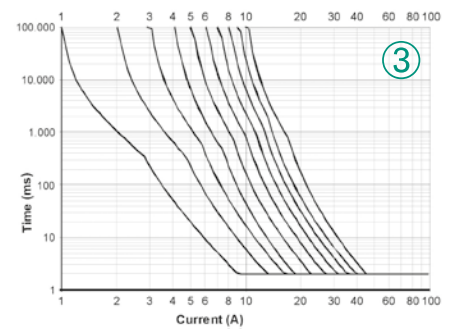
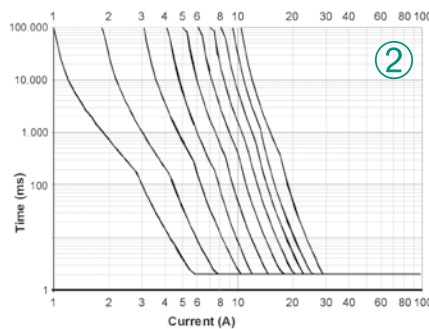
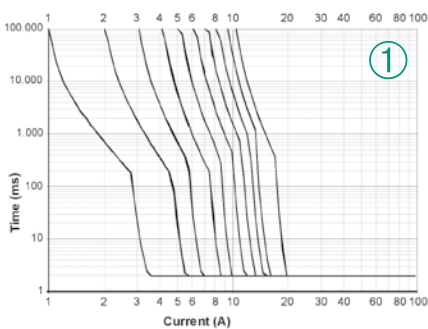

# EMI filter quick selection table

These tables are used for quickly identifying items and verifying whether all of the product's technical details satisfy the set requirements.

## 3-phase filter without neutral 400-480 Vac

Current	Common mode (L / PE) attenuation (dB)						Differential mode (L / L) attenuation (dB)						Cat. No.	Page
	0.15 MHz	0.5 MHz	1 MHz	5 MHz	10 MHz	30 MHz	0.15 MHz	0.5 MHz	1 MHz	5 MHz	10 MHz	30 MHz		
7 A	20	60	60	60	50	35	25	60	65	60	55	40	XF07TDVST2	55
16 A	15	50	55	60	50	35	25	55	60	60	55	40	XF16TDVST2	55
30 A	15	50	55	60	50	35	25	55	60	60	55	40	XF30TDVST2	55
42 A	55	70	70	45	35	20	45	45	45	45	45	30	XF42TDVST2	55
55 A	15	55	55	55	50	35	25	55	60	60	50	40	XF55TDVST2	55
75 A	15	55	55	55	50	30	20	50	50	50	55	40	XF75TDVST2	55
100 A	35	50	45	25	15	7	30	35	35	35	30	7	XF100TDVST2	55
150 A	20	30	40	45	40	30	30	40	40	45	40	25	XF150TDS84C	56
180 A	20	30	40	45	40	30	30	40	40	45	40	25	XF180TDS84C	56
200 A	55	60	55	30	20	–	45	30	25	10	10	5	XF200TDDS84C	57
300 A	30	30	23	10	8	5	35	30	25	14	10	5	XF300TDS84C	58
400 A	30	30	20	10	5	2	30	30	20	10	8	2	XF400TDS84C	58

## 3-phase filter with neutral 400-480 Vac

Current	Common mode (L / PE) attenuation (dB)						Differential mode (L / L) attenuation (dB)						Cat. No.	Page
	0.15 MHz	0.5 MHz	1 MHz	5 MHz	10 MHz	30 MHz	0.15 MHz	0.5 MHz	1 MHz	5 MHz	10 MHz	30 MHz		
10 A	10	20	20	20	30	25	10	20	25	25	30	30	XF10TYG9	60
16 A	25	50	50	50	45	30	35	55	60	60	40	30	XF16TYT8	59
20 A	10	15	20	35	40	25	10	15	20	20	25	20	XF20TYS9	60
25 A	25	50	50	50	45	30	35	55	60	60	40	30	XF25TYT8	59
36 A	25	50	50	50	40	25	30	50	55	50	40	30	XF36TYT8	59
50 A	25	45	45	40	40	25	30	50	50	40	40	30	XF50TYT8	59
100 A	10	20	25	30	30	20	30	40	40	35	35	25	XF100TYT8	59

## Single-cell single-phase filter 120-250 Vac

Current	Common mode (L / PE) attenuation (dB)						Differential mode (L / L) attenuation (dB)						Cat. No.	Page
	0.15 MHz	0.5 MHz	1 MHz	5 MHz	10 MHz	30 MHz	0.15 MHz	0.5 MHz	1 MHz	5 MHz	10 MHz	30 MHz		
3 A	20	30	35	45	50	45	7	35	50	45	45	45	XF03DKBG5B	61
6 A	15	20	25	40	45	45	10	20	45	45	50	45	XF06DKBG5B	61
12 A	10	20	22	35	45	40	10	20	40	45	45	45	XF12DKBG5B	61
16 A	10	18	20	35	45	30	10	18	40	40	40	35	XF16DKCG5B	61
20 A	10	18	20	30	35	35	10	12	35	35	40	40	XF20DKCG5B	61
30 A	10	25	30	45	50	35	12	40	50	50	50	45	XF30DKCS5B	61

## Double-cell single-phase filter 120-250 Vac

Current	Common mode (L / PE) attenuation (dB)						Differential mode (L / L) attenuation (dB)						Cat. No.	Page
	0.15 MHz	0.5 MHz	1 MHz	5 MHz	10 MHz	30 MHz	0.15 MHz	0.5 MHz	1 MHz	5 MHz	10 MHz	30 MHz		
3 A	45	60	60	55	45	45	12	45	45	45	45	45	XF03DPCG5C	62
6 A	30	50	60	55	50	35	8	45	45	45	45	45	XF06DPCG5C	62
12 A	15	25	35	55	55	35	12	40	40	35	35	40	XF12DPCG5C	62
16 A	20	35	45	60	50	35	12	40	40	45	45	50	XF16DPCG5C	62
20 A	15	40	45	50	50	40	12	45	45	45	35	50	XF20DPCG5C	62
30 A	10	30	35	55	45	30	18	45	50	40	40	40	XF30DPGS5C	62

# 3-phase filter without neutral TDV series

- Models from 7 to 130 A
- Elevated attenuation from 150 kHz to 30 MHz
- Elevated attenuation even on long cables
- Minimum surface occupied on the panel

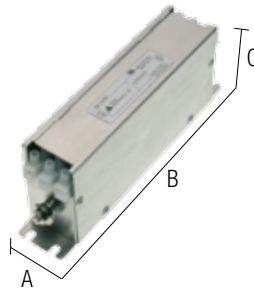

## NOTES

The dimensions and diagrams are purely indicative, for more detailed information see the product's technical data.

(1) The capacitors between phase and neutral, requires that the isolation tests are carried out in DC in accordance with EN60950

(2) Version made to order (not kept in stock); contact our sales office for availability.

## BLOCK DIAGRAM

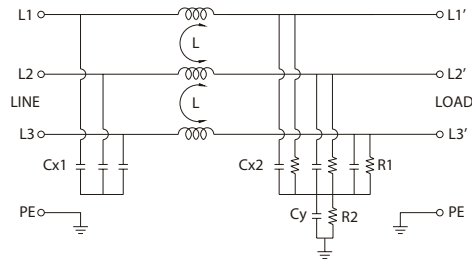

## VERSIONS

Nominal current	Type	Cat. No.
7 A	<b>F 07 TDV ST2</b>	XF07TDVST2 (2)
16 A	<b>F 16 TDV ST2</b>	XF16TDVST2 (2)
30 A	<b>F 30 TDV ST2</b>	XF30TDVST2 (2)
42 A	<b>F 42 TDV ST2</b>	XF42TDVST2 (2)
55 A	<b>F 55 TDV ST2</b>	XF55TDVST2 (2)
75 A	<b>F 75 TDV ST2</b>	XF75TDVST2 (2)
100 A	<b>F 100 TDV ST2</b>	XF100TDVST2 (2)

## Dimensions

A	B	C	Weight (kg)
42	192	72	
47	252	72	
52	272	87	
52	312	87	
87	252	92	
92	272	137	
90	270	150	

## GENERAL TECHNICAL DATA

Nominal voltage	480 Vac $\pm$ 10%
Nominal current	See table for versions
Frequency	50...60 Hz
Leakage current at 480 Vac 60 Hz	30 mA
Operating temperature range	-25...+85°C
Isolation L/L	1.45 KVdc / 60 s (1)
Isolation L/PE	2.25 KVdc / 60 s (1)
Overvoltage category / Pollution degree	—
Protection degree	IP 20 IEC 529, EN60529
Connection type	fixed screw terminal blocks
Housing material	metallic
Approximate weight	See table for versions
Mounting information	on panels by means of anchorage screws

Type	Common mode (L / PE) attenuation (dB)						Differential mode (L / L) attenuation (dB)					
	0.15 MHz	0.5 MHz	1 MHz	5 MHz	10 MHz	30 MHz	0.15 MHz	0.5 MHz	1 MHz	5 MHz	10 MHz	30 MHz
<b>F 07 TDV ST2</b>	20	60	60	60	50	35	25	60	65	60	55	40
<b>F 16 TDV ST2</b>	15	50	55	60	50	35	25	55	60	60	55	40
<b>F 30 TDV ST2</b>	15	50	55	60	50	35	25	55	60	60	55	40
<b>F 42 TDV ST2</b>	55	70	70	45	35	20	45	45	45	45	45	30
<b>F 55 TDV ST2</b>	15	55	55	55	50	35	25	55	60	60	50	40
<b>F 75 TDV ST2</b>	15	55	55	55	50	30	20	50	50	50	55	40
<b>F 100 TDV ST2</b>	35	50	45	25	15	7	30	35	35	35	30	7

## 3-phase filter without neutral TDS series

- Models from 150 to 180 A
- Elevated attenuation from 150 kHz to 30 MHz
- Elevated attenuation even on long cables

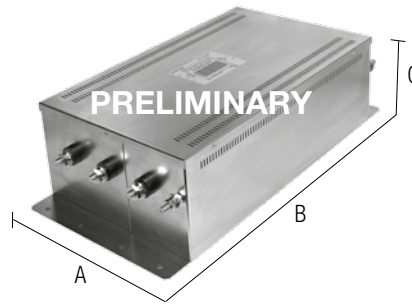

### NOTES

The dimensions and diagrams are purely indicative, for more detailed information see the product's technical data.

(1) Version made to order (not kept in stock); contact our sales office for availability.

(2) The capacitors between phase and neutral, requires that the isolation tests are carried out in DC in accordance with EN60950.

### BLOCK DIAGRAM

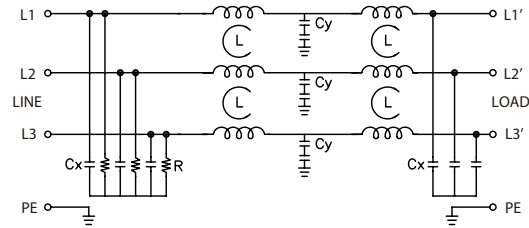

### VERSIONS

Nominal current	Type	Cat. No.
150 A	<b>F 150 TDS 84C</b>	XF150TDS84C (1)
180 A	<b>F 180 TDS 84C</b>	XF180TDS84C (1)

### Dimensions

A	B	C	Weight (kg)
202	390	122	
202	390	122	

### Weight (kg)

### GENERAL TECHNICAL DATA

Nominal voltage	480 Vac $\pm$ 10%
Nominal current	See table for versions
Frequency	50...60 Hz
Leakage current at 480 Vac 60 Hz	500 mA
Operating temperature range	-25...+85°C
Line/line isolation	1 KVdc / 60 s (2)
Line/PE isolation	1 KVdc / 60 s (150A) – 2.25 KVdc / 60 s (180A) (2)
Overvoltage category / Pollution degree	—
Protection degree	IP 20 IEC 529, EN60529
Connection type	self-blocking nut
Housing material	metallic
Approximate weight	See table for versions
Mounting information	on panels by means of anchorage screws

# 3-phase filter without neutral TDDS series

- Elevated attenuation from 150 kHz to 30 MHz
- Elevated attenuation even on long cables

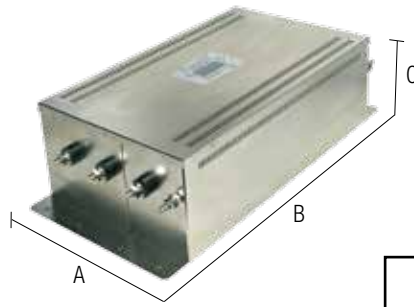

Item available until supplies last

## NOTES

The dimensions and diagrams are purely indicative, for more detailed information see the product's technical data.

- (1) Item available until supplies last.
- (2) The capacitors between phase and neutral, requires that the isolation tests are carried out in DC in accordance with EN60950.

## BLOCK DIAGRAM

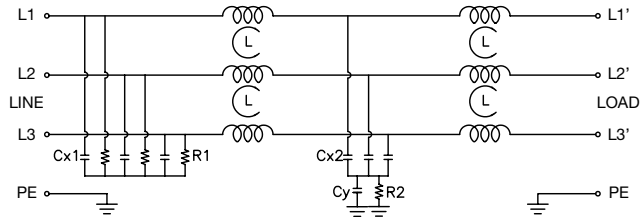

VERSIONS			
Nominal current	Type	Cat. No.	
200 A	<b>F 200 TDDS 84C</b>	XF200TDDS84C	(1)

Dimensions			Weight (kg)
A	B	C	
240	477	140	

## GENERAL TECHNICAL DATA

Nominal voltage	480 Vac ± 10%
Nominal current	200 A
Frequency	50...60 Hz
Leakage current at 480 Vac 60 Hz	500 mA
Operating temperature range	-25...+85°C
Line/line isolation	1 KVdc / 60 s (2)
Line/PE isolation	1.8 KVdc / 60 s (2)
Overvoltage category / Pollution degree	—
Protection degree	IP 20 IEC 529, EN60529
Connection type	self-blocking nut
Housing material	metallic
Approximate weight	See table for versions
Mounting information	on panels by means of anchorage screws

Type	Common mode (L / PE) attenuation (dB)						Differential mode (L / L) attenuation (dB)					
	0.15 MHz	0.5 MHz	1 MHz	5 MHz	10 MHz	30 MHz	0.15 MHz	0.5 MHz	1 MHz	5 MHz	10 MHz	30 MHz
<b>F 200 TDDS 84C</b>	55	60	55	30	20	/	45	30	25	10	10	5



## 3-phase filter without neutral TDSS series

- Models from 300 to 600 A
- Elevated attenuation from 150 kHz to 30 MHz
- Elevated attenuation even on long cables

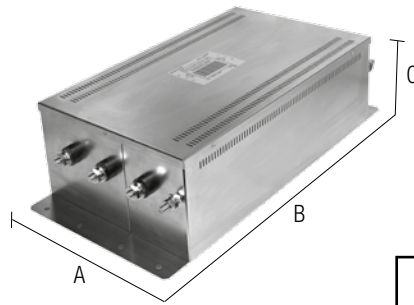

Item available until supplies last

### NOTES

The dimensions and diagrams are purely indicative, for more detailed information see the product's technical data.

- (1) Item available until supplies last.
- (2) The capacitors between phase and neutral, requires that the isolation tests are carried out in DC in accordance with EN60950.

### BLOCK DIAGRAM

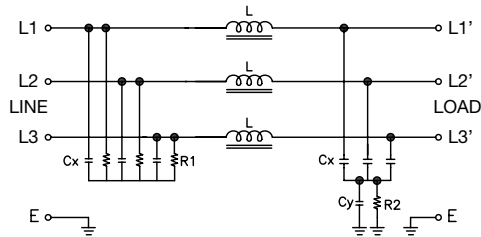

VERSIONS			
Nominal current	Type	Cat. No.	
300 A	<b>F 300 TDSS 84C</b>	XF300TDSS84C	(1)
400 A	<b>F 400 TDSS 84C</b>	XF400TDSS84C	(1)

Dimensions			Weight (kg)
A	B	C	
242	525	142	
242	525	142	

GENERAL TECHNICAL DATA	
Nominal voltage	480 Vac $\pm$ 10%
Nominal current	See table for versions
Frequency	50...60 Hz
Leakage current at 480 Vac 60 Hz	1000 mA
Operating temperature range	-25...+85°C
Line/line isolation	0.6 KVdc / 60 s (2)
Line/PE isolation	1 KVdc / 60 s (2)
Overvoltage category / Pollution degree	—
Protection degree	IP 20 IEC 529, EN60529
Connection type	flat plug
Housing material	metallic
Approximate weight	See table for versions
Mounting information	on panels by means of anchorage screws

## 3-phase filter with neutral TYT series

- Models from 16 to 100 A
- Elevated attenuation from 150 kHz to 30 MHz
- Elevated attenuation even on long cables

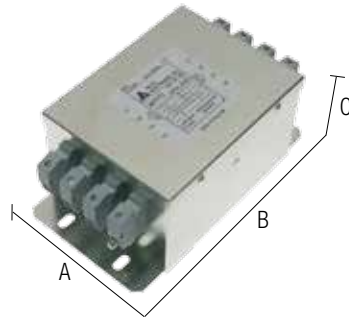

### NOTES

The dimensions and diagrams are purely indicative, for more detailed information see the product's technical data.

- (1) The capacitors between phase and neutral, requires that the isolation tests are carried out in DC in accordance with EN60950.
- (2) Version made to order (not kept in stock); contact our sales office for availability.

### BLOCK DIAGRAM

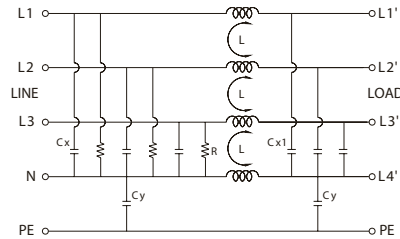

### VERSIONS

Nominal current	Type	Cat. No.
36 A	<b>F 36 TYT8</b>	XF36TYT8 (2)
50 A	<b>F 50 TYT8</b>	XF50TYT8 (2)
100 A	<b>F 100 TYT8</b>	XF100TYT8 (2)

### Dimensions

A	B	C	Weight (kg)
107	191.5	82	
124	194	104	
162	252	132	

### GENERAL TECHNICAL DATA

Nominal voltage	440 Vac $\pm$ 10%		
Nominal current	See table for versions		
Frequency	50...60Hz		
Leakage current at 480 Vac 60 Hz	3 mA		
Operating temperature range	-25...+85°C		
Line/line isolation	1.45 KVdc / 60 s	(1)	
Line/PE isolation	2.25 KVdc / 60 s	(1)	
Overvoltage category / Pollution degree	—		
Protection degree	IP 20 IEC 529, EN60529		
Connection type	fixed screw terminal blocks		
Housing material	metallic		
Approximate weight	See table for versions		
Mounting information	on panels by means of anchorage screws		

Type	Common mode (L / PE) attenuation (dB)						Differential mode (L / L) attenuation (dB)					
	0.15 MHz	0.5 MHz	1 MHz	5 MHz	10 MHz	30 MHz	0.15 MHz	0.5 MHz	1 MHz	5 MHz	10 MHz	30 MHz
<b>F 36 TYT8</b>	25	50	50	50	40	25	30	50	55	50	40	30
<b>F 50 TYT8</b>	25	45	45	40	40	25	30	50	50	40	40	30
<b>F 100 TYT8</b>	10	20	25	30	30	20	30	40	40	35	35	25

# Compact 3-phase filter with neutral TY series

- Models from 10 to 20 A
- Elevated attenuation from 150 kHz to 30 MHz
- Elevated attenuation even on long cables
- Excellent quality/price/performance ratio



## NOTES

The dimensions and diagrams are purely indicative, for more detailed information see the product's technical data.

(1) The capacitors between phase and neutral, requires that the isolation tests are carried out in DC in accordance with EN60950.

(2) Version made to order (not kept in stock); contact our sales office for availability.

## BLOCK DIAGRAM

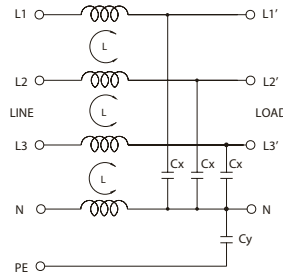

## VERSIONS

Nominal current	Type	Cat. No.
10 A	<b>F 10 TYG9</b>	XF10TYG9 (2)
20 A	<b>F 20 TYS9</b>	XF20TYS9 (2)

## Dimensions

A	B	C	Weight (kg)
50	85	44	
50	97	44	

## GENERAL TECHNICAL DATA

Nominal voltage	440 Vac $\pm$ 10%		
Nominal current	See table for versions		
Frequency	50...60Hz		
Leakage current at 480 Vac 60 Hz	0.5 mA		
Operating temperature range	-25...+85°C		
Line/line isolation	1.45 KVdc / 60 s	(1)	
Line/PE isolation	2.25 KVdc / 60 s	(1)	
Overtoltage category / Pollution degree	—		
Protection degree	IP 20 IEC 529, EN60529		
Connection type	flat plug (10 A) and screw (20 A)		
Housing material	metallic		
Approximate weight	See table for versions		
Mounting information	on panels by means of anchorage screws		

Type	Common mode (L / PE) attenuation (dB)						Differential mode (L / L) attenuation (dB)					
	0.15 MHz	0.5 MHz	1 MHz	5 MHz	10 MHz	30 MHz	0.15 MHz	0.5 MHz	1 MHz	5 MHz	10 MHz	30 MHz
<b>F 10T YG9</b>	10	20	20	20	30	25	10	20	25	25	30	30
<b>F 20 TYS9</b>	10	15	20	20	25	20	10	15	20	20	25	20

# Single-cell single-phase filter DK series

- Models from 3 to 30 A
- Elevated attenuation from 150 kHz to 30 MHz
- Elevated attenuation even on long cables
- Minimum surface occupied on the panel



## NOTES

The dimensions and diagrams are purely indicative, for more detailed information see the product's technical data.

- (1) 0.25 mA at 115 Vac and 0.45 mA at 250 Vac for 3...20 A - 1 mA at 115 Vac models and 2 mA at 250 Vac for 30 A models.
- (2) Version made to order (not kept in stock); contact our sales office for availability.
- (3) Flat plug for 3...20 A models; self-blocking nut for 30 A model.
- (4) The capacitors between phase and neutral, requires that the isolation tests are carried out in DC in accordance with EN60950.

## BLOCK DIAGRAM

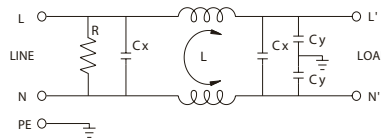

## VERSIONS

Nominal current	Type	Cat. No.
3 A	<b>F 03 DK BG5B</b>	XF03DKBG5B (2)
6 A	<b>F 06 DK BG5B</b>	XF06DKBG5B (2)
12 A	<b>F 12 DK BG5B</b>	XF12DKBG5B (2)
16 A	<b>F 16 DK CG5B</b>	XF16DKCG5B (2)
20 A	<b>F 20 DK CG5B</b>	XF20DKCG5B (2)
30 A	<b>F 30 DK CS5B</b>	XF30DKCS5B (2)

Dimensions			Weight (kg)
A	B	C	
64.5	34	30	
64.5	34	30	
64.5	34	30	
45.5	71.5	30	
51.8	84.8	30	
56.5	114	46.4	

## GENERAL TECHNICAL DATA

Nominal voltage	115–250 Vac $\pm$ 10%		
Nominal current	See table for versions		
Frequency	50...60 Hz		
Leakage current at 480 Vac 60 Hz	0.25...1 mA / 0.45...2 mA	(1)	
Operating temperature range	-25...+85°C		
Line/line isolation	1.45 KVdc / 60 s	(4)	
Line/PE isolation	2.25 KVdc / 60 s	(4)	
Overtoltage category / Pollution degree	—		
Protection degree	IP 20 IEC 529, EN60529		
Connection type	flat plug (from 3 to 20 A) / self-blocking nut (30 A) (3)		
Housing material	metallic		
Approximate weight	See table for versions		
Mounting information	on panels by means of anchorage screws		

Type	Common mode (L / PE) attenuation (dB)						Differential mode (L / L) attenuation (dB)					
	0.15 MHz	0.5 MHz	1 MHz	5 MHz	10 MHz	30 MHz	0.15 MHz	0.5 MHz	1 MHz	5 MHz	10 MHz	30 MHz
<b>F 03 DK BG5B</b>	20	30	35	45	50	45	7	35	50	45	45	45
<b>F 06 DK BG5B</b>	15	20	25	40	45	45	10	20	45	45	50	45
<b>F 12 DK BG5B</b>	10	20	22	35	45	40	10	20	40	45	45	45
<b>F 16 DK CG5B</b>	10	18	20	35	45	30	10	18	40	40	40	35
<b>F 20 DK CG5B</b>	10	18	20	30	35	35	10	12	35	35	40	40
<b>F 30 DK CS5B</b>	10	25	30	45	50	35	12	40	50	50	50	45

# Double-cell single-phase filter DP series

- Models from 3 to 30 A
- Elevated attenuation from 150 kHz to 30 MHz
- Elevated attenuation even on long cables
- Minimum surface occupied on the panel

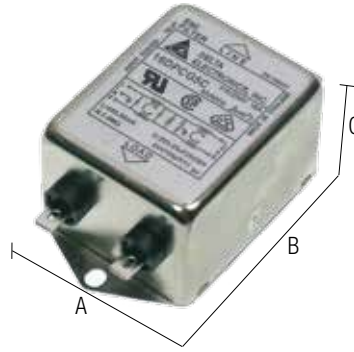

## NOTES

The dimensions and diagrams are purely indicative, for more detailed information see the product's technical data.

- (1) 0.25 mA at 115 Vac and 0.45 mA at 250 Vac for 3...20 A - 1 mA at 115 Vac models and 2 mA at 250 Vac for 30 A models.
- (2) Version made to order (not kept in stock); contact our sales office for availability.
- (3) Flat plug for 3...20 A models; self-blocking nut for 30 A model.
- (4) The capacitors between phase and neutral, requires that the isolation tests are carried out in DC in accordance with EN60950.

## BLOCK DIAGRAM

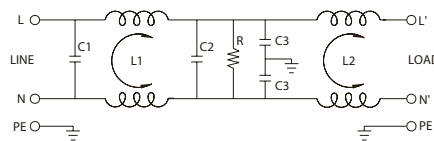

## VERSIONS

Nominal current	Type	Cat. No.
3 A	<b>F 03 DP CG5C</b>	XF03DPCG5C (2)
6 A	<b>F 06 DP CG5C</b>	XF06DPCG5C (2)
12 A	<b>F 12 DP CG5C</b>	XF12DPCG5C (2)
16 A	<b>F 16 DP CG5C</b>	XF16DPCG5C (2)
20 A	<b>F 20 DP CG5C</b>	XF20DPCG5C (2)
30 A	<b>F 30 DP GS5C</b>	XF30DPGS5C (2)

## Dimensions

A	B	C	Weight (kg)
84.8	75	52	
152.9	143	51.3	
84.8	75	52	
56.5		46.4	

## GENERAL TECHNICAL DATA

Nominal voltage	115–250 Vac ± 10%
Nominal current	See table for versions
Frequency	50...60 Hz
Leakage current at 480 Vac 60 Hz	0.25...1 mA / 0.45...2 mA (1)
Operating temperature range	-25...+85°C
Line/line isolation	1.45 KVdc / 60 s (4)
Line/PE isolation	2.25 KVdc / 60 s (4)
Overtoltage category / Pollution degree	—
Protection degree	IP 20 IEC 529, EN60529
Connection type	flat plug (from 3 to 20 A) / self-blocking nut (30 A) (3)
Housing material	metallic
Approximate weight	See table for versions
Mounting information	on panels by means of anchorage screws

Type	Common mode (L / PE) attenuation (dB)						Differential mode (L / L) attenuation (dB)					
	0.15 MHz	0.5 MHz	1 MHz	5 MHz	10 MHz	30 MHz	0.15 MHz	0.5 MHz	1 MHz	5 MHz	10 MHz	30 MHz
<b>F 03 DP CG5C</b>	45	60	60	55	45	45	12	45	45	45	45	45
<b>F 06 DP CG5C</b>	30	50	60	55	50	35	8	45	45	45	45	45
<b>F 12 DP CG5C</b>	15	25	35	55	55	35	12	40	40	35	35	40
<b>F 16 DP CG5C</b>	20	35	45	60	50	35	12	40	40	45	45	50
<b>F 20 DP CG5C</b>	15	40	45	50	50	40	12	45	45	40	35	50
<b>F 30 DP GS5C</b>	10	30	35	55	45	30	18	45	50	40	40	40

# Analogue converters

## Applications of analogue converters and galvanic separation

They convert electrical signals generated by sensors which take physical measurements such as temperature (thermocouples and PT100 resistance thermometers), frequency (proximity, contacts, photocells), current (TA, Hall sensors), resistance (potentiometers), voltage, pressure, level, etc. into standardised electrical signals, adapting them to PLC, DCS and industrial PC (control) outputs, or they convert a given analogue signal into a different one, adapting it to control inputs/outputs or allowing for long-distance signal transmission without interference by means of galvanic separation (fig. 1).

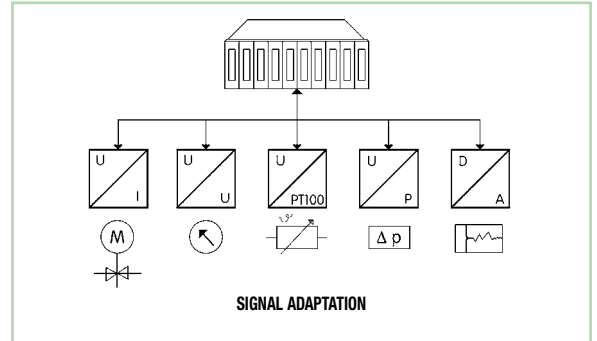

fig. 1

### Adaptation between sensor output signal and control input signal

physical measurement taken	sensor output	converter input		converter output	
Temperature	Normally one of the following signals indicated in the next column	0 – 60 mV	±60 mV	0 – 5 V	±5 V
Frequency		0 – 100 mV	±100 mV	0 – 10 V	±10 V
Current		0 – 500 mV	±500 mV	0 – 20 mA	±20 mA
Resistance		0 – 1 V	±1 V	4 – 20 mA	
Voltage		0 – 5 V	±5 V		
Pressure		0 – 10 V	±10 V		
Level measurement		0 – 5 mA	±5 mA		
		0 – 10 mA	±10 mA		
		0 – 20 mA	±20 mA		
		0 – 20 mA			

### Long-distance signal transmission

Voltage signals can reach a max. distance of 10-20 m, beyond which they lose reliability and become highly sensitive to induced and ground-derived interference, therefore in order to transmit to distances beyond 20 m a voltage signal must be converted into a current signal and galvanically separated (fig. 2).

Current signals can surpass a transmission distance of 300 m and are less sensitive to induced interference. The long-distance transmission of a current signal requires galvanic separation.

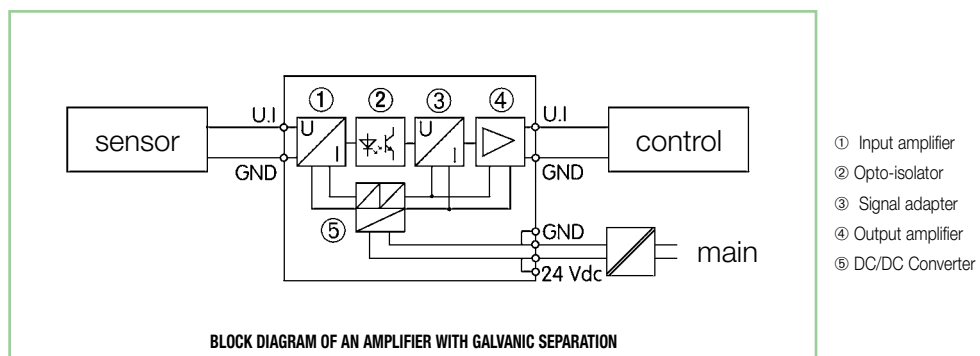

fig. 2



## Galvanic signal separation

### (signal isolation):

- isolates and electrically separates the sensor circuit from the control circuit and from the power supply circuit; each circuit therefore operates in relation to its own zero potential which, being isolated from other circuits, cannot be altered by ever-present potential differences between different ground references (fig.3)

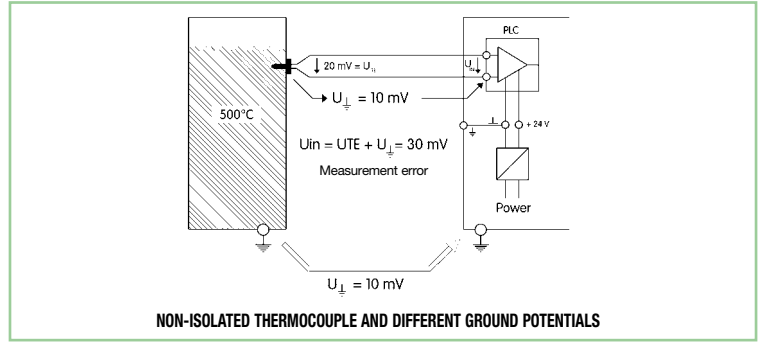

fig. 3

- isolates and separates different ground potentials between power supply, control and sensors/actuators
- allows for signal transmission without errors or interference and with greater reliability
- the higher the isolation (in kV), the greater the security of the transmission in the presence of ground potentials, electromagnetic or temporary interference (lightning, discharge, etc.). (fig 4)

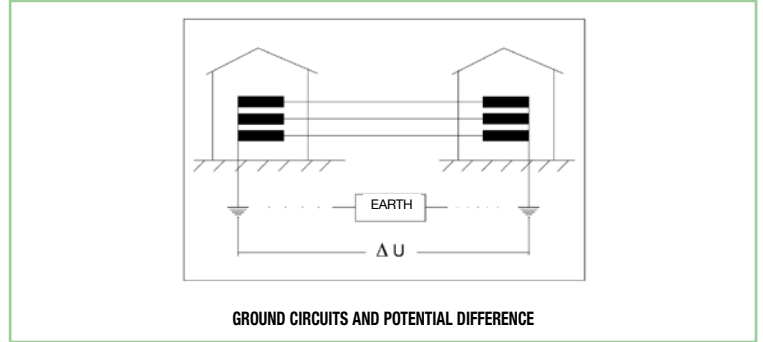

fig. 4

### Galvanic separation is necessary when:

- the distance between control and sensor/actuator is greater than 20 m
- ground or mass references are different
- ground potentials are high, or may become high in case of discharges or currents leaked to ground
- electromagnetic interference is present
- signal cables are wired in ducts with power cables (fig. 5)

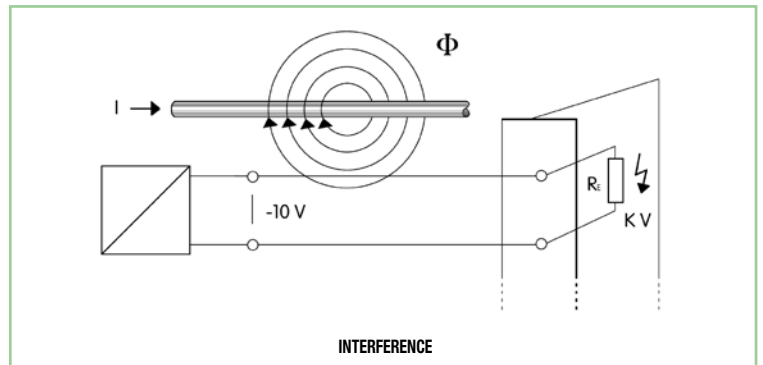

fig. 5

### Connection of analogue converters in series and in parallel

- To obtain signal redundancy or to simply duplicate it, multiple converter inputs can be connected to a single sensor.
- In case of current signals, the converter input will be connected in series (fig. 6)

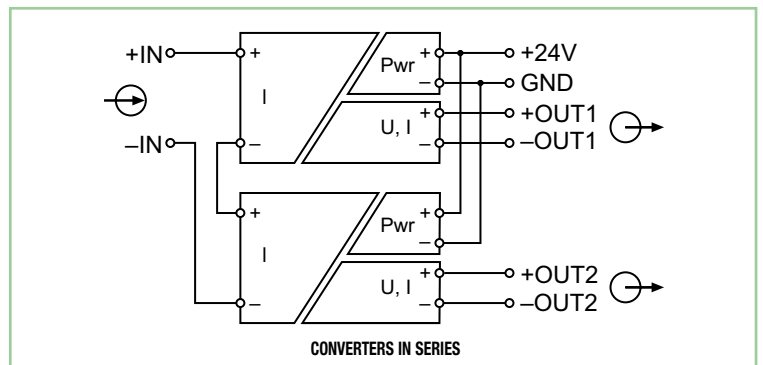

fig. 6

- In case of voltage signals, the converter input will be connected in parallel (fig. 7)

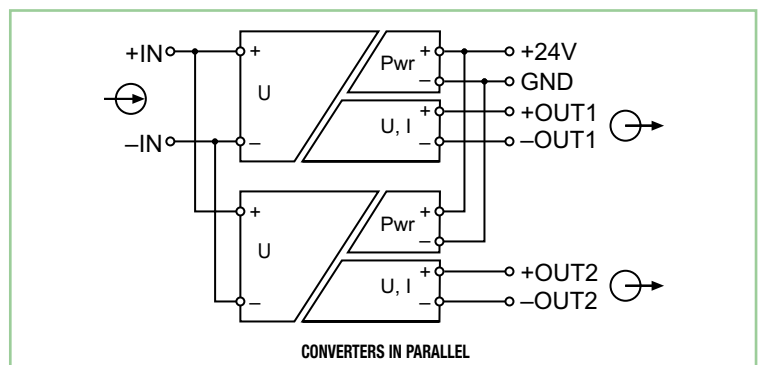

fig. 7

# Analogue quick selection table

These tables are used for quickly identifying items and verifying whether all of the product's technical details satisfy the set requirements.

## Analogue signal converter and separators

Input	Output	Isolation	Power supply	Notes	Type	Cat. No.	Page
0...60 / 0...100 / 0...500 mV ±60 / ±100 / ±500 mV 0...1 / 0...2 / 0...5 / 0...10 V ±1 / ±2 / ±5 / ±10 V 0...5 / 0...10 / 0...20 / 4...20 mA ±5 / ±10 / ±20 mA	0...5 / 0...10 / ±5 / ±10 V 0...20 / 4...20 / ±20 mA	3-way	24 Vdc	(1) (4)	CAIPI03	XCAIPI03	67
0...60 / 0...100 / 0...300 / 0...500 mV 0...1 / 0...10 / 0...20 / 2...20 V 0...5 / 0...10 / 0...20 / 4...20 / ±5 / ±20 mA	0...10 V 0...20 / 4...20 mA	3-way	24 Vac/dc	(1) (4)	CWJAA 6-0516	X756516	68
0...10 V 0...20 / 4...20 mA	0...10 V 0...20 / 4...20 mA	3-way	24 Vac/dc	(1) (4)	CWNA 7-0539	X756539	69
0...10 V	0...10 V	3-way	24 Vac/dc	(2) (4)	CWAA 6-0530	X756530	70
0...10 V	0...20 mA	3-way	24 Vac/dc	(2) (4)	CWAA 6-0531	X756531	70
0...10 V	4...20 mA	3-way	24 Vac/dc	(2) (4)	CWAA 6-0532	X756532	70
0...20 mA	0...10 V	3-way	24 Vac/dc	(2) (4)	CWAA 6-0533	X756533	71
0...20 mA	0...20 mA	3-way	24 Vac/dc	(2) (4)	CWAA 6-0534	X756534	71
0...20 mA	4...20 mA	3-way	24 Vac/dc	(2) (4)	CWAA 6-0535	X756535	71
4...20 mA	0...10 V	3-way	24 Vac/dc	(2) (4)	CWAA 6-0536	X756536	72
4...20 mA	0...20 mA	3-way	24 Vac/dc	(2) (4)	CWAA 6-0537	X756537	72
4...20 mA	4...20 mA	3-way	24 Vac/dc	(2) (4)	CWAA 6-0538	X756538	72
0...20 / 4...20 mA	0...20 / 4...20 mA	2-way	—	(4)	CWPAA 7-0526	X756526	73
0...20 / 4...20 mA	0...20 / 4...20 mA	2-way	—	(3) (4)	CWPAA 7-0527	X756527	73
-30...+30 V / -50...+50 mA / -5...+5 A	2 thresholds (NA contacts)	3-way	24 Vdc	(6) (7)	LCONALSFDI	X756360	74

### Notes

- (1) DIP-switch programmable input and output signals  
 (2) fixed (non-calibratable) input and output signals, version made to order (not kept in stock), for information contact our sales office  
 (3) two-channel version  
 (4) two-way 1.5 k Vac/60 s (input/output) or three-way 1.5 k Vac / 60 s (input/output/power supply) isolation  
 (5) three-way 4 k Vac/60 s (input/output/power supply) isolation  
 (6) DIP-switch and software programmable input and output signals  
 (7) three-way 2.5 k Vac/60 s (input/output/power supply) isolation

## Current converters

Input	Output	Isolation	Power supply	Notes	Type	Cat. No.	Page
0...50 A ac	adjustable threshold 1...30 A	2-way	24 Vdc	(3) (4)	CCIS-2	XCCIS2	79
0...1 A ac/dc	0...10 V 0...20 / 4...20 mA	3-way	24 Vdc	(2)	WAA 7-0540	X756540	80
0...5 A ac/dc	0...10 V 0...20 / 4...20 mA	3-way	24 Vdc	(2)	WAA 7-0541	X756541	80
0...10 A ac/dc	0...10 V 0...20 / 4...20 mA	3-way	24 Vdc	(2)	WAA 7-0542	X756542	80

### Notes

- (1) version with single input and output signals  
 (2) version with three selectable output signals  
 (3) version with open collector threshold output  
 (4) version with threshold output with 1 exchange relay

## Frequency/analogue programmable converters

Input	Output	Isolation	Power supply	Notes	Type	Cat. No.	Page
0...28.8 kHz (21 steps)	0...10 V 0...20 / 4...20 mA	2-way	24 Vac/dc	(1)	CWNFA 6-0524	X756524	82

# Analogue quick selection table

These tables are used for quickly identifying items and verifying whether all of the product's technical details satisfy the set requirements.

## Auxiliary power supply for sensors and potentiometers

Input	Output	Isolation	Power supply	Notes	Type	Cat. No.	Page
24 Vdc	10 Vdc	2-way			CWCV 7-6184	X766184	83

## NPN and PNP signal inverter

Input	Output	Isolation	Power supply	Notes	Type	Cat. No.	Page
NPN (17...30 Vdc)	PNP				CI-NPN/PNP	XNPNPNP	84
PNP (17...30 Vdc)	NPN				CI-NPN/PNP	XNPNPNP	84

## Temperature sensor converters

Sensor type	Input	Output	Isolation	Power supply	Notes	Type	Cat. No.	Page
PT100 and PT1000 (2, 3, 4 wires) Thermocouples B, C, E, J, K, N, R, S, T 0-600 kOhm potentiometers	Programmable -200...+2400°C (-328...+4352°F) based on sensor type	0...10 V / -10...+10 V 0...20 mA / 4...+20 mA	3-way	24 Vdc	(1) (2)	LCONTADFDT	X756340	75
PT100 and PT1000 (2, 3, 4 wires) Thermocouples B, C, E, J, K, N, R, S, T 0-600 kOhm potentiometers	Programmable -200...+2400°C (-328...+4352°F) based on sensor type	2 thresholds (NA contacts)	3-way	24 Vdc	(2)	LCONTLSFDT	X756370	76
PT100 3 wires (RTD)	-50...+50°C (-58...+122°F) -50...+100°C (-58...+212°F) -50...+150°C (-58...+302°F) 0...+100°C (+32...+212°F) 0...+150°C (+32...+302°F) 0...+200°C (+32...+392°F) 0...+300°C (+32...+572°F) 0...+400°C (+32...+752°F)	0...10 V 0...20 / 4...20 mA	3-way	24 Vac/dc	(2)	CWPT 6-0816	X756816	77
Thermocouples J (FeCuNi) and K (NiCrNi)	-50...+200°C (-58...+392°F) -50...+350°C (-58...+662°F) 0...+200°C (+32...+392°F) 0...+400°C (+32...+752°F) 0...+600°C (+32...+1112°F) 0...+800°C (+32...+1472°F) 0...+1000°C (+32...+1832°F) 0...+1200°C (+32...+2192°F)	0...10 V 0...20 / 4...20 mA	3-way	24 Vac/dc	(2)	CWTH 6-0844	X756844	78

### Notes

(1) software programmable input and output signals

(2) DIP-switch programmable input and output signals

# Analogue programmable signal converters

- 19 input steps
- 7 output steps
- 1 failure contact
- Input/Output isolation > 3 kVac
- Auxiliary power supply for loop powered sensors
- Potentiometer input

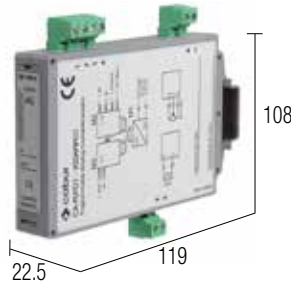

TAB.1 - INPUT SELECTION TABLE

INPUT RANGE		SW1 (INPUT)							
UNIPOLAR	BIPOLAR	1	2	3	4	5	6	7	8
0 - 60mV	± 60 mV								
0 - 100mV	± 100 mV		•						
0 - 500 mV	± 500 mV			•					
0 - 1 V	± 1 V				•				
0 - 2 V	± 2 V						•		
0 - 5 V	± 5 V			•	•	•	•		
0 - 10 V	± 10 V								•
0 - 5 mA	± 5 mA	•		•					
0 - 10 mA	± 10 mA	•			•				
0 - 20 mA	± 20 mA	•						•	
4 - 20 mA	—	•					•		•

## NOTES

Depth measurements include terminal block and rail clamp clearance.

(1) Stock cards are programmed and calibrated with input 0...10 V and output 0...10 V. cards programmed and calibrated for all other possible configurations are available upon request.

## BLOCK DIAGRAM

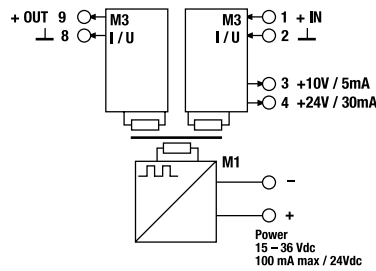

TAB.2 - OUTPUT SELECTION TABLE

OUTPUT RANGE	INPUT TYPE	SW2 (OUTPUT)								SW3	
		1	2	3	4	5	6	7	8		
0 - 5 V	UNIP.	X		•						•	U
	BIP.	X	•	•						•	U
± 5 V	UNIP.	X		•						•	U
	BIP.	X	•	•						•	U
0 - 10 V	UNIP.	X		•							U
	BIP.	X	•	•						•	U
± 10 V	UNIP.	X		•							U
	BIP.	X	•	•							U
0 - 20 mA	UNIP.	X		•					X		I
	BIP.	X	•	•					X	•	I
± 20 mA	UNIP.	X		•					X		I
	BIP.	X	•	•					X	•	I
4 - 20 mA	UNIP.	X			•	•	•	•	X		I
	BIP.	X	•		•	•	•	•	X	•	I

• = ON  
= OFF  
X = ANY

## VERSIONS

Standard

## Cat. No. XCAPI03

CAPI03

## INPUT TECHNICAL DATA

Input signal (1)	19 programmable steps (see tab. 1)
Voltage/current impedance	1 MΩ / 50 Ω
Max. input voltage	15 V
Max. input current	30 mA

## OUTPUT TECHNICAL DATA

Output signal (1)	7 programmable steps (see tab. 2)
Voltage/current output load	≥ 10 kΩ / ≤ 500 Ω
Max. output voltage	12 V
Max. outrush current	25 mA

## GENERAL TECHNICAL DATA

Power supply voltage	15...36 Vdc
Power consumption	100 mA max. at 24 Vdc
Max. auxiliary voltage I	10 Vdc 5 mA / 24 Vdc 30 mA
Gain error	< 0.1% FS
Offset error	< 0.05% FS
Linearity error	< 0.1% FS
Zero adjustment/span adj.	± 10% FS / ± 10% FS
Conversion frequency	400Hz...1kHz depending on full scale
Rise time	150 mV / μs
Bandwidth	1 kHz at -6 dB
Phase delay	< 10 μs
Input/Output/Power supply isolation	> 3 kVac / 60 s
Permanent voltage isolation	800 Vac max.
Reference Standards	IEC 664-1, DIN VDE0110.1
Overvoltage category / Pollution degree	III / 2
Operating temperature range	-10... +65°C
Δ T	5°C
Protection degree	IP 20 IEC 529, EN60529
EMC standards	EN 50081-2, EN 50082-2
Connection type	2.5 mm <sup>2</sup> removable screw terminal blocks
Housing material	UL94V-0 polyamide
Approximate weight	150 g
Mounting information	vertical on rails, space 5 mm from adjacent components

## MOUNTING ACCESSORIES

Mounting rail type according to IEC60715/TH35-7.5	PR/3/AC, PR/3/AC/ZB, PR/3/AS, PR/3/AS/ZB
Mounting rail type according to IEC60715/G32	—
Jumper	red white blue

## INPUT STAGE

The module can manage single-pole and two-pole inputs selecting between steps (see TAB. 1):

- 0...60 mV ± 60 mV
- 0...100 mV ± 100 mV
- 0...500 mV ± 500 mV
- 0...1 V ± 1 V
- 0...5 V ± 5 V
- 0...10 V ± 10 V
- 0...5 mA ± 5 mA
- 0...10 mA ± 10 mA
- 0...20 mA ± 20 mA
- 4...20 mA

The input stage provides two power supplies (10 V and 24 V) for remote sensors. It is possible to run potentiometers and directly power 4...20 mA two-wire loop sensors.

Connection examples:

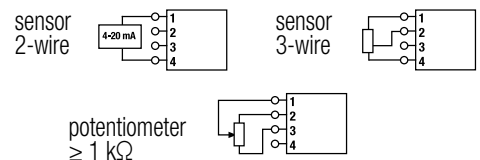

## OUTPUT STAGE

The module provides single-pole and two-pole output signals with the following steps (see Tab. 2):

- 0...5 V ± 5 V
- 0...10 V ± 10 V
- 0...20 mA ± 20 mA
- 4...20 mA

# Programmable analogue signal converter

- 3-way galvanic separation
- 14 programmable input ranges
- 3 programmable output ranges
- Simplified programming
- Version available with 24-240 Vac/dc power supply



## NOTES

Depth measurements include terminal block and rail clamp clearance.

- (1) settable using a rotary switch
- (2) settable using a DIP-switch
- (3) range 16.8...30 Vdc / 19.2...28.8 Vac
- (4) range 16.8...264 Vdc / 19.2...264 Vac
- (5) 3-way, IN/OUT/power supply
- (6) Version made to order (not kept in stock); contact our sales office for availability.

## BLOCK DIAGRAM

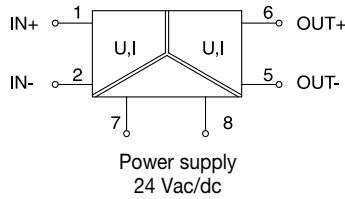

## VERSIONS

Cat. No. X756516

CWUAA 6-0516

## APPLICATIONS

Converts and galvanically isolates the main standardised analogue signals; input programmable with 14 signal ranges and output with the three most used standardised signals. Configuration is obtained by setting the DIP-switches on the side.

This module offers multiple in/out signal combinations, allowing for significant savings in terms of costs, time and storage space and in the management of spare parts.

3-way galvanic separation ensures total isolation between input, output and power supply which, together with automatic signal calibration, ensures excellent precision without the need for calibration.

Where multiple output channels are needed for a single signal source, multiple converters may be used connecting the signal inputs in parallel, in the case of voltage signals, or in series, in the case of current signals.

## INPUT TECHNICAL DATA

Input signal (1)

**0...60 / 0...100 / 0...300 / 0...500 mV**  
**0...1 / 0...10 / 0...20 / 2...20 V**  
**0...5 / 0...10 / 0...20 / 4...20 / ±5 / ±20 mA**  
 330 kΩ with voltage input  
 100 kΩ with current input

Input resistance

## OUTPUT TECHNICAL DATA

Output signal (2)

**0...10 V**  
**0...20 / 4...20 mA**  
 >1 kΩ with voltage output  
 <400 Ω with current output

Applicable load

## GENERAL TECHNICAL DATA

Power supply voltage

**24 Vac/dc** (3)

Power consumption

≤ 35 mA ± 10% at 24 Vdc

Accuracy

0.1% at 23°C FS

Conversion frequency

< 30 Hz

Temperature coefficient

0.02% / K FS

Isolation

1.5 kVac / 60 s (5)

EMC standards

EN 50081-2, EN 50082-2

Reference Standards

IEC 664-1, DIN VDE

Overvoltage category / Pollution degree

III / 2

Protection degree

IP 20 IEC 529, EN60529

Operating temperature range

-25...+60°C

Connection type

2.5 mm<sup>2</sup> fixed screw terminal blocks

Housing material

UL94V-0 Noryl

Approximate weight

65 g

Mounting information

vertical on rails, side by side

## MOUNTING ACCESSORIES

Mounting rail type according to IEC60715/TH35-7.5

**PR/3/AC, PR/3/AC/ZB, PR/3/AS, PR/3/AS/ZB**

Mounting rail type according to IEC60715/G32

Jumper

red

(16 poles, 16 A)

white

blue

# Programmable analogue signal converters

- 1.5 kV 3-way input/output/power supply isolation
- 3 programmable input ranges
- 3 programmable output ranges
- Simplified, self-adjusting programming
- Version available with 24-240 Vac/dc power supply



## NOTES

Depth measurements include terminal block and rail clamp clearance.

- (1) range 16.8...30 Vdc / 19.2...28.8 Vac
- (2) range 16.8...264 Vdc / 19.2...264 Vac
- (3) 3-way, IN/OUT/power supply

## BLOCK DIAGRAM

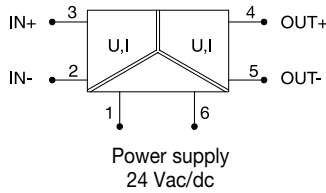

## VERSIONS

Cat. No. X756539

CWNAA-7-0539

## APPLICATIONS

Convert and galvanically isolate the main standardised analogue signals; input programmable with 3 signal ranges and output with the 3 most used standard signals. Configuration is obtained by setting the DIP-switches on the side. Programmable in the most used signal combinations, these cards allow for a significant cost saving over the more complex 14 range version. Where multiple output channels are needed for a single signal source, multiple converters may be used connecting the signal inputs in parallel (with voltage signals) or in series (with current signals).

## INPUT TECHNICAL DATA

Input signal

Input resistance

0...10 V

0...20 / 4...20 mA

330 k $\Omega$  with voltage input  
100  $\Omega$  with current input

## OUTPUT TECHNICAL DATA

Output signal

Applicable load

0...10 V

0...20 / 4...20 mA

>1 k $\Omega$  with voltage output  
<400  $\Omega$  with current output

## GENERAL TECHNICAL DATA

Power supply voltage

Power consumption

Accuracy

Conversion frequency

Temperature coefficient

Isolation

EMC standards

Reference Standards

Overvoltage category / Pollution degree

Protection degree

Operating temperature range

Connection type

Housing material

Approximate weight

Mounting information

24 Vac/dc (1)

$\leq 35$  mA  $\pm 10\%$  at 24 Vdc

0.1% at 23°C FS

< 30 Hz

0.02% / K FS

1.5 kVac / 60 s (3)

EN 61000-6-2, EN 61000-6-4

IEC 664-1, DIN VDE

III / 2

IP 20 IEC 529, EN60529

-25...+60°C

2.5 mm<sup>2</sup> fixed screw terminal blocks

UL94V-0 Noryl

40 g

vertical on rails, side by side

## MOUNTING ACCESSORIES

Mounting rail type according to IEC60715/TH35-7.5

Mounting rail type according to IEC60715/G32

Jumper

(16 poles, 16 A)

red

white

blue

PR/3/AC, PR/3/AC/ZB, PR/3/AS, PR/3/AS/ZB

CWBK 7-0802 Cat. No. X766802

CWBK 7-0803 Cat. No. X766803

CWBK 7-0804 Cat. No. X766804



# Analogue signal converters

- 1.5 kV 3-way input/output/power supply isolation
- Fixed value
- Compact size, 6.2 mm thick



## NOTES

Depth measurements include terminal block and rail clamp clearance.

(1) range 16.8...30 Vdc / 19.2...28.8 Vac

(2) 3-way, IN/OUT/power supply

## BLOCK DIAGRAM

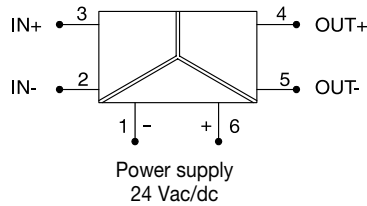

## VERSIONS

IN: 0...10 V / OUT: 0...10 V

IN: 0...10 V / OUT: 0...20 mA

IN: 0...10 V / OUT: 4...20 mA

### INPUT TECHNICAL DATA

Input signal

Input resistance

### OUTPUT TECHNICAL DATA

Output signal

Applicable load

### GENERAL TECHNICAL DATA

Power supply voltage

Power consumption

Accuracy

Conversion frequency

Temperature coefficient

Isolation

EMC standards

Reference Standards

Overvoltage category / Pollution degree

Protection degree

Operating temperature range

Connection type

Housing material

Approximate weight

Mounting information

Cat. No. X756530

Cat. No. X756531

Cat. No. X756532

CWAA 7-0530

CWAA 7-0531

CWAA 7-0532

0...10 V

330 k $\Omega$

0...10 V

330 k $\Omega$

0...10 V

330 k $\Omega$

0...10 V

>1 k $\Omega$

0...20 mA

<400  $\Omega$

4...20 mA

<400  $\Omega$

24 Vac/dc (1)

$\leq 13$  mA  $\pm 10\%$

0.1% at 23°C FS

< 30 Hz

0.02% / K FS

1.5 kVac / 60 s (2)

EN 61000-6-2, EN 61000-6-4

IEC 664-1, DIN VDE

III / 2

IP 20 IEC 529, EN60529

-25...+60°C

2.5 mm<sup>2</sup> fixed screw terminal blocks

PPE

40 g

vertical on rails, side by side

24 Vac/dc (1)

$\leq 13$  mA  $\pm 10\%$

0.1% at 23°C FS

< 30 Hz

0.02% / K FS

1.5 kVac / 60 s (2)

EN 61000-6-2, EN 61000-6-4

IEC 664-1, DIN VDE

III / 2

IP 20 IEC 529, EN60529

-25...+60°C

2.5 mm<sup>2</sup> fixed screw terminal blocks

PPE

40 g

vertical on rails, side by side

24 Vac/dc (1)

$\leq 13$  mA  $\pm 10\%$

0.1% at 23°C FS

< 30 Hz

0.02% / K FS

1.5 kVac / 60 s (2)

EN 61000-6-2, EN 61000-6-4

IEC 664-1, DIN VDE

III / 2

IP 20 IEC 529, EN60529

-25...+60°C

2.5 mm<sup>2</sup> fixed screw terminal blocks

PPE

40 g

vertical on rails, side by side

## APPLICATIONS

Convert and galvanically isolate the main analogue signals into a proportional signal; each model is designed to convert a single analogue signal providing a substantial reduction in components and costs, making it the perfect solution for large plants and applications which use multiple signals of the same type, where programmable cards would drive up costs. Equipped with 3-way galvanic separation between input, output and power supply. Where multiple output channels are needed for a single signal source, multiple converters may be used connecting the signal inputs in parallel (with voltage signals) or in series (with current signals).

## MOUNTING ACCESSORIES

Mounting rail type according to IEC60715/TH35-7.5

Mounting rail type according to IEC60715/G32

Jumper red  
(16 poles, 16 A) white  
blue

## PR/3/AC, PR/3/AC/ZB, PR/3/AS, PR/3/AS/ZB

CWBK 7-0802 Cat. No. X766802

CWBK 7-0803 Cat. No. X766803

CWBK 7-0804 Cat. No. X766804

# Analogue signal converters

- 1.5 kV 3-way input/output/power supply isolation
- Fixed value
- Compact size, 6.2 mm thick



## NOTES

Depth measurements include terminal block and rail clamp clearance.

- (1) range 16.8...30 Vdc / 19.2...28.8 Vac
- (2) 3-way, IN/OUT/power supply
- (3) Version made to order (not kept in stock); contact our sales office for availability.

## BLOCK DIAGRAM

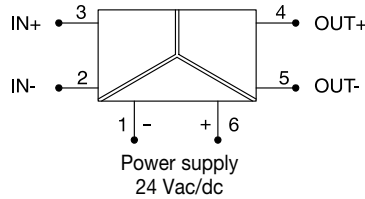

## VERSIONS

IN: 0...20 mA / OUT: 0...10 V

IN: 0...20 mA / OUT: 0...20 mA

IN: 0...20 mA / OUT: 4...20 mA

Cat. No. X756533

CWAA 7-0533 (3)

Cat. No. X756534

CWAA 7-0534 (3)

Cat. No. X756535

CWAA 7-0535 (3)

## INPUT TECHNICAL DATA

Input signal

Input resistance

0...20 mA

100 Ω

0...20 mA

100 Ω

0...20 mA

100 Ω

## OUTPUT TECHNICAL DATA

Output signal

Applicable load

0...10 V

>1 kΩ

0...20 mA

<400 Ω

4...20 mA

<400 Ω

## GENERAL TECHNICAL DATA

Power supply voltage

Power consumption

Accuracy

Conversion frequency

Temperature coefficient

Isolation

EMC standards

Reference Standards

Overvoltage category / Pollution degree

Protection degree

Operating temperature range

Connection type

Housing material

Approximate weight

Mounting information

24 Vac/dc (1)

≤ 13 mA ± 10%

0.1% at 23°C FS

< 30 Hz

0.02% / K FS

1.5 kVac / 60 s (2)

EN 61000-6-2, EN 61000-6-4

IEC 664-1, DIN VDE

III / 2

IP 20 IEC 529, EN60529

-25...+60°C

2.5 mm<sup>2</sup> fixed screw terminal blocks

PPE

40 g

vertical on rails, side by side

24 Vac/dc (1)

≤ 13 mA ± 10%

0.1% at 23°C FS

< 30 Hz

0.02% / K FS

1.5 kVac / 60 s (2)

EN 61000-6-2, EN 61000-6-4

IEC 664-1, DIN VDE

III / 2

IP 20 IEC 529, EN60529

-25...+60°C

2.5 mm<sup>2</sup> fixed screw terminal blocks

PPE

40 g

vertical on rails, side by side

24 Vac/dc (1)

≤ 13 mA ± 10%

0.1% at 23°C FS

< 30 Hz

0.02% / K FS

1.5 kVac / 60 s (2)

EN 61000-6-2, EN 61000-6-4

IEC 664-1, DIN VDE

III / 2

IP 20 IEC 529, EN60529

-25...+60°C

2.5 mm<sup>2</sup> fixed screw terminal blocks

PPE

40 g

vertical on rails, side by side

## APPLICATIONS

Convert and galvanically isolate the main analogue signals into a proportional signal; each model is designed to convert a single analogue signal providing a substantial reduction in components and costs, making it the perfect solution for large plants and applications which use multiple signals of the same type, where programmable cards would drive up costs. Equipped with 3-way galvanic separation between input, output and power supply. Where multiple output channels are needed for a single signal source, multiple converters may be used connecting the signal inputs in parallel (with voltage signals) or in series (with current signals).

## MOUNTING ACCESSORIES

Mounting rail type according to IEC60715/TH35-7.5

Mounting rail type according to IEC60715/G32

Jumper  
(16 poles, 16 A)

red  
white  
blue

PR/3/AC, PR/3/AC/ZB, PR/3/AS, PR/3/AS/ZB

CWBK 7-0802 Cat. No. X766802  
CWBK 7-0803 Cat. No. X766803  
CWBK 7-0804 Cat. No. X766804

# Analogue signal converters

- 1.5 kV 3-way input/output/power supply isolation
- Fixed value
- Compact size, 6.2 mm thick



## NOTES

Depth measurements include terminal block and rail clamp clearance.

(1) range 16.8...30 Vdc / 19.2...28.8 Vac

(2) 3-way, IN/OUT/power supply

(3) Version made to order (not kept in stock); contact our sales office for availability.

## BLOCK DIAGRAM

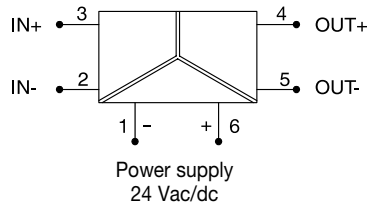

## VERSIONS

IN: 4...20 mA / OUT: 0...10 V

IN: 4...20 mA / OUT: 0...20 mA

IN: 4...20 mA / OUT: 4...20 mA

## INPUT TECHNICAL DATA

Input signal

Input resistance

## OUTPUT TECHNICAL DATA

Output signal

Applicable load

## GENERAL TECHNICAL DATA

Power supply voltage

Power consumption

Accuracy

Conversion frequency

Temperature coefficient

Isolation

EMC standards

Reference Standards

Overvoltage category / Pollution degree

Protection degree

Operating temperature range

Connection type

Housing material

Approximate weight

Mounting information

Cat. No. X756536

Cat. No. X756537

Cat. No. X756538

CWAA 7-0536

CWAA 7-0537 (3)

CWAA 7-0538

4...20 mA

100 Ω

4...20 mA

100 Ω

4...20 mA

100 Ω

0...10 V

>1 kΩ

0...20 mA

<400 Ω

4...20 mA

<400 Ω

24 Vac/dc (1)

≤ 13 mA ± 10%

0.1% at 23°C FS

< 30 Hz

0.02% / K FS

1.5 kVac / 60 s (2)

EN 61000-6-2, EN 61000-6-4

IEC 664-1, DIN VDE

III / 2

IP 20 IEC 529, EN60529

-25...+60°C

2.5 mm<sup>2</sup> fixed screw terminal blocks

PPE

40 g

vertical on rails, side by side

24 Vac/dc (1)

≤ 13 mA ± 10%

0.1% at 23°C FS

< 30 Hz

0.02% / K FS

1.5 kVac / 60 s (2)

EN 61000-6-2, EN 61000-6-4

IEC 664-1, DIN VDE

III / 2

IP 20 IEC 529, EN60529

-25...+60°C

2.5 mm<sup>2</sup> fixed screw terminal blocks

PPE

40 g

vertical on rails, side by side

24 Vac/dc (1)

≤ 13 mA ± 10%

0.1% at 23°C FS

< 30 Hz

0.02% / K FS

1.5 kVac / 60 s (2)

EN 61000-6-2, EN 61000-6-4

IEC 664-1, DIN VDE

III / 2

IP 20 IEC 529, EN60529

-25...+60°C

2.5 mm<sup>2</sup> fixed screw terminal blocks

PPE

40 g

vertical on rails, side by side

## APPLICATIONS

Convert and galvanically isolate the main analogue signals into a proportional signal; each model is designed to convert a single analogue signal providing a substantial reduction in components and costs, making it the perfect solution for large plants and applications which use multiple signals of the same type, where programmable cards would drive up costs. Equipped with 3-way galvanic separation between input, output and power supply. Where multiple output channels are needed for a single signal source, multiple converters may be used connecting the signal inputs in parallel (with voltage signals) or in series (with current signals).

## MOUNTING ACCESSORIES

Mounting rail type according to IEC60715/TH35-7.5

Mounting rail type according to IEC60715/G32

Jumper red  
(16 poles, 16 A) white  
blue

## PR/3/AC, PR/3/AC/ZB, PR/3/AS, PR/3/AS/ZB

—  
CWBK 7-0802 Cat. No. X766802  
CWBK 7-0803 Cat. No. X766803  
CWBK 7-0804 Cat. No. X766804

# Passive galvanic isolators

- Do not require power supply
- Adapted to loop powered sensors
- 500 V 2-way input/output isolation
- One- and two-channel versions
- Compact size, 6,2 mm thick

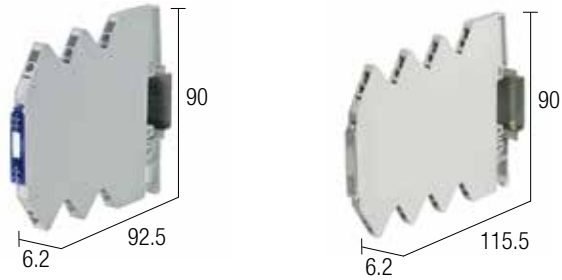

## NOTES

Depth measurements include terminal block and rail clamp clearance.

(1) Input voltage must be greater than that taken from the formula, where  $R_b$  is the resistance of the applied load (see figure 1); to make things easier we have provided a graph of the minimum input voltage based on the variation in applied output load (see figure 2); only this value is able to ensure the maximum output current of 20 mA

(2) 2-way, IN/OUT

(3) Version made to order (not kept in stock); contact our sales office for availability.

## BLOCK DIAGRAM

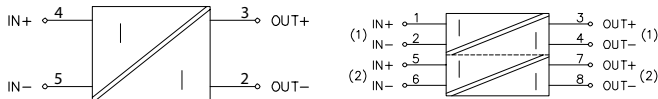

## VERSIONS

Single channel  
Double channel

### INPUT TECHNICAL DATA

Input signal	1 channel 0...20 mA, 4...20 mA
Input current	—
Input voltage (1)	2.7 + (20 mA x $R_b$ )
Input resistance	100 $\Omega$

### OUTPUT TECHNICAL DATA

Output signal	1 channel 0...20 / 4...20 mA, (max 21 mA)
Applicable load	<400 $\Omega$ with current output

### GENERAL TECHNICAL DATA

Power supply voltage	—
Power consumption	12 mA
Accuracy	0.1 FS (23°C)
Rise time (10..90%)	10 ms
Conversion frequency	30 Hz at 3 dB
Temperature coefficient	0.02% FS
Isolation	1.5 kVac / 60 s (2)
EMC standards	EN 61000-6-2, EN 61000-6-4
Reference Standards	IED 664-1, DIN VDE
Overvoltage category / Pollution degree	III / 2
Protection degree	IP 20 IEC 529 EN60529
Operating temperature range	-25...+60°C
Connection type	1.5 mm <sup>2</sup> fixed screw terminal blocks
Housing material	Luranyl
Approximate weight	35 g
Mounting information	vertical on rails, side by side

### MOUNTING ACCESSORIES

Mounting rail type according to IEC60715/TH35-7.5	—
Mounting rail type according to IEC60715/G32	—
Jumper (16 poles, 16 A)	red white blue

## Cat. No. X756526

CWPAA 7-0526

## Cat. No. X756527

CWPAA 7-0527 (3)

1 channel 0...20 mA, 4...20 mA

2 channels 0...20 mA, 4...20 mA

2.7 + (20 mA x  $R_b$ )  
100  $\Omega$

2.7 + (20 mA x  $R_b$ )  
100  $\Omega$

1 channel 0...20 / 4...20 mA, (max 21 mA)  
<400  $\Omega$  with current output

2 channels 0...20 / 4...20 mA, (max 21 mA)  
<400  $\Omega$  with current output

PR/3/AC, PR/3/AG/ZB, PR/3/AS, PR/3/AS/ZB

CWBK 7-0802 Cat. No. X766802

CWBK 7-0803 Cat. No. X766803

CWBK 7-0804 Cat. No. X766804

## APPLICATIONS

Passive galvanic isolators are used to separate signals generated by active (i.e. powered) sensors, and are also referred to as current loop or loop powered. The load applied to them must have a resistance of below 400  $\Omega$  at 20 mA, including the resistance of the conductors. The input voltage delivered must be 2.7 V higher than the output voltage (see note 1).

When these use conditions are met, passive converters are able to reduce wiring costs for power supply cables and prevent the need for external power supplies; they are not suitable for long connection wiring since they can heavily influence the output signal level.

fig. 1

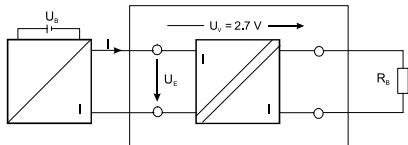
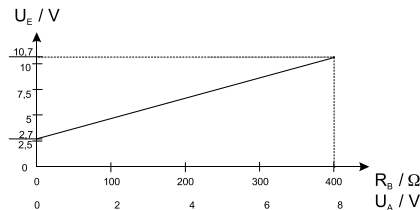
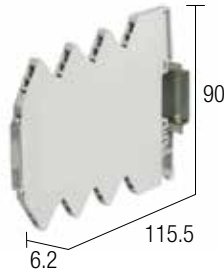

fig. 2



# Monitor module for analogue signal

- 3-way galvanic separation
- Dip-switch and FDT/DTM software programmable input ranges
- FDT/DTM software programmable output thresholds
- Simplified programming



Programming kit X756894



## NOTES

The depth measurement includes rail clamp clearance.  
 (1) Version made to order (not kept in stock); contact our sales office for availability.  
 (3) 2-way, IN/OUT

## BLOCK DIAGRAM

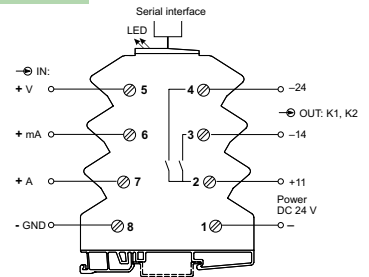
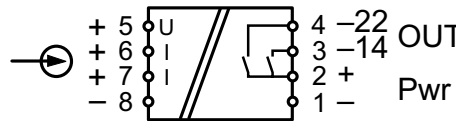

## VERSIONS

With screw terminal blocks (standard)

With spring terminal blocks

Programming kit

## INPUT TECHNICAL DATA

Input signal (1)

Input resistance

Zero / Spam

## OUTPUT TECHNICAL DATA

Threshold adjustment

Contact type

Max. switchable voltage and current

Status display

Operating mode

## GENERAL TECHNICAL DATA

Power supply voltage

Power consumption

Accuracy

Data processing

Linearity error

Temperature coefficient

Response time

Isolation

EMC standards

Reference Standards

Surge category / Degree of pollution

Protection degree

Operating temperature range

Connection type

Housing material

Approximate weight

Mounting information

## MOUNTING ACCESSORIES

Mounting rail type according to IEC60715/TH35-7.5

Mounting rail type according to IEC60715/G32

Jumper  
 (16 poles, 16 A)

red  
 white  
 blue

Cat. No. X756360

LCONALS (1)

Cat. No. X756894

LCONZBUSB (1)

-30...+30 V

330 kΩ

-50...+50 mA

30 Ω

-5...+5 A

10 mΩ

adjustable using FDT/DTM software

programmable using FDT/DTM software

2 NA contacts (solid state relay)

30 Vdc / 100 mA

2 yellow LEDs

limit value, window, trend, inversion and memory

24 Vdc (16.8...30 Vdc)

18 mA ± 10% at 24 Vdc

0.1% FS

24 Bit

< 100 ppm FS

<100 ppm/°C

1...500 ms (adjustable, default 30 ms)

2.5 kVac / 60 s (3)

EN 50081-2, EN 50082-2

IEC 664-1, DIN VDE

III / 2

IP20

-40...+70°C

1.5 mm<sup>2</sup> fixed screw terminal blocks

UL94V-0 Noryl

600 g

vertical on rails, side by side

PR/3/AC, PR/3/AG/ZB, PR/3/AS, PR/3/AS/ZB

CWBK 7-0802 cat. no. X766802

CWBK 7-0803 cat. no. X766803

CWBK 7-0804 cat. no. X766804

## APPLICATIONS

CWTPR 7-0360 is a "universal" converter for a wide range of analogue signals that can be used with the most popular models of analogue sensors on the market. Both input ranges and output thresholds can be changed using FDT/DTM software and a USB interface.

The normally open contacts of the two output thresholds are managed by two solid state relays.

# Programmable temperature/analogue converter

- For PT100 and PT1000 sensors, thermocouples, potentiometers
- 2.5 kV 3-way input/output isolation
- 145 DIP-switch selectable input ranges, customisable using FDT/DTM software
- 5 DIP-switch selectable output ranges, customisable using FDT/DTM software
- Compact size, 6.2 mm thick

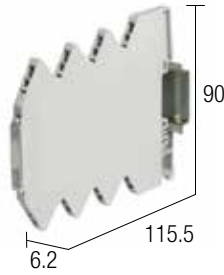

Programming kit X756894

## NOTES

- Depth measurements include terminal block and rail clamp clearance.
- (1) Version made to order (not kept in stock); contact our sales office for availability.
  - (2) Input temperature range and output signal range can be selected using a DIP-switch or customised using FDT/DTM software.
  - (3) 3-way, IN/OUT/power supply

## BLOCK DIAGRAM

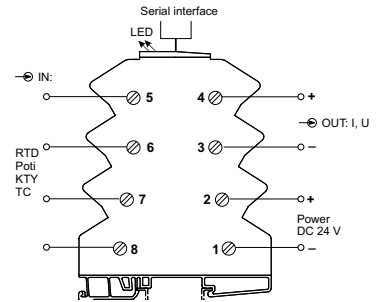
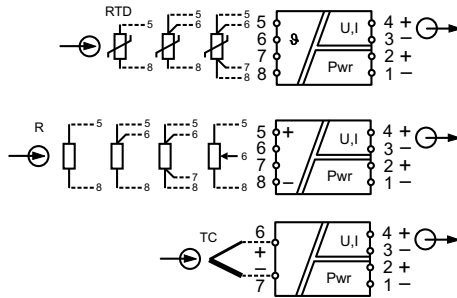

## VERSIONS

With screw terminal blocks (standard)

With spring terminal blocks

Programming kit

### INPUT TECHNICAL DATA

Input signal

Temperature range

### OUTPUT TECHNICAL DATA

Output signal

Applicable load

Warnings

Cat. No. X756340

Cat. No. X756894

LCONTAD (1)

(1)

LCONZBUSB (1)

PT100, PT1000, potentiometer 0...600k $\Omega$   
Thermocouples types B, C, E, J, K, N, R, S, T  
-200...+2400°C, based on sensor (2)

0...10 / -10...+10 V, (max. 10.25 V)  
0...20 / 4...20 mA, (max 21 mA) (2)  
>2 k $\Omega$  with voltage output  
<650  $\Omega$  with current output  
Green LED = OK, flashing red LED = error

## APPLICATIONS

CWTPR 7-0340 is a "universal" transducer for a wide range of temperature sensors that can be used for precise temperature measurement with the most popular models of temperature sensors on the market. Measurements can be taken in low and high temperature ranges (e.g. in air conditioners) and in process control. The flexibility of the system allows it to be used from -200 to 1400°C. With resistive sensors, the connection method may be based on 2, 3 or 4 wire technologies. Both input and output ranges can be changed using FDT/DTM software and a USB interface.

## GENERAL TECHNICAL DATA

Power supply voltage	24 Vdc (16.8...30 Vdc)
Power consumption	18 mA max. at 24 Vdc
Accuracy	10K/span(K) + 0.2% FS (for PT) / 10K/span(K) + 0.4% FS (for TC)
Data processing	24 bit
Linearity error	$\pm 0.05\%$ FS (for PT and potentiometer) / $\pm 0.1\%$ FS (for TC)
Temperature coefficient	<100 ppm/°C
Response time	5...500 ms (adjustable, default 30 ms)
Isolation	2.5 kVac / 60 s (3)
EMC standards	EN 61000-6-2, EN 61000-6-4
Reference Standards	IEC 664-1, DIN VDE
Surge category / Degree of pollution	III / 2
Protection degree	IP 20 IEC 529 EN60529
Operating temperature range	-40...+70°C
Connection type	1.5 mm <sup>2</sup> fixed screw terminal block
Housing material	PA
Approximate weight	40 g
Mounting information	vertical on rails, side by side

## MOUNTING ACCESSORIES

Mounting rail type according to IEC60715/TH35-7.5		<b>PR/3/AC, PR/3/AC/ZB, PR/3/AS, PR/3/AS/ZB</b>
Mounting rail type according to IEC60715/G32		—
Jumper	red white blue	CWBK 7-0802 Cat. No. X766802 CWBK 7-0803 Cat. No. X766803 CWBK 7-0804 Cat. No. X766804

Range*	S1			S2						
Start	7	8	12	End	3	4	5	6	7	8
-200°C	●			0°C	●					
-150°C	●			50°C	●					
-100°C	●	●		100°C	●					
-50°C	●	●		150°C	●	●				
0°C	●	●	●	200°C	●	●	●			
Sensor*	S1	1	2	3	250°C	●	●	●	●	
PT100	●			300°C	●	●	●	●	●	
PT1000	●			350°C	●	●	●	●	●	
TE J	●	●		400°C	●	●	●	●	●	
TE K	●	●	●	450°C	●	●	●	●	●	
R	●	●	●	500°C	●	●	●	●	●	
	●	●	●	550°C	●	●	●	●	●	
Output*	S1	4	5	6	600°C	●	●	●	●	
0-20mA	●			650°C	●	●	●	●	●	
4-20mA	●			700°C	●	●	●	●	●	
0-10V	●	●		750°C	●	●	●	●	●	
$\pm 10V$	●	●	●	800°C	●	●	●	●	●	
	●	●	●	850°C	●	●	●	●	●	
S1-S2 1-8 off:				900°C	●	●	●	●	●	
FDT/DTM				950°C	●	●	●	●	●	
				1000°C	●	●	●	●	●	
				1050°C	●	●	●	●	●	
				1100°C	●	●	●	●	●	
				1150°C	●	●	●	●	●	
				1200°C	●	●	●	●	●	
				1250°C	●	●	●	●	●	
				1300°C	●	●	●	●	●	
				1350°C	●	●	●	●	●	
				1400°C	●	●	●	●	●	
					●	→	Switch On			



# Monitor module for temperature sensor

- For PT100 and PT1000 sensors, thermocouples, potentiometers
- 2.5 kV 3-way input/output isolation
- 145 DIP-switch selectable input ranges, customisable using FDT/DTM software
- Two FDT/DTM software programmable output thresholds
- Compact size, 6.2 mm thick

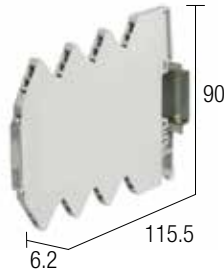

Programming kit X756894



## NOTES

Depth measurements include terminal block and rail clamp clearance.

- (1) Version made to order (not kept in stock); contact our sales office for availability.
- (2) The input temperature range and output thresholds can be selected using a DIP-switch or customised using FDT/DTM software.
- (3) 3-way, IN/OUT/power supply

## BLOCK DIAGRAM

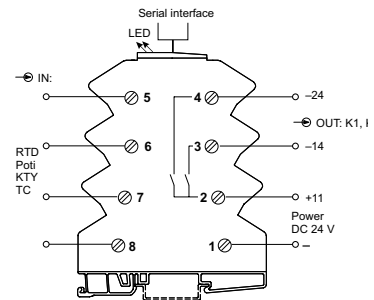
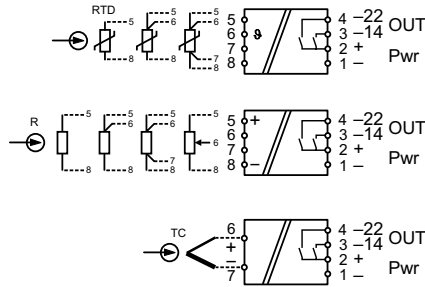

## VERSIONS

With screw terminal blocks (standard)

With spring terminal blocks

Programming kit

## INPUT TECHNICAL DATA

Input signal

Temperature range

## OUTPUT TECHNICAL DATA

Threshold adjustment

Contact type

Max. switchable voltage and current

Status display

Operating mode

## GENERAL TECHNICAL DATA

Power supply voltage

Power consumption

Accuracy

Data processing

Linearity error

Temperature coefficient

Response time

Isolation

EMC standards

Reference Standards

Surge category / Degree of pollution

Protection degree

Operating temperature range

Connection type

Housing material

Approximate weight

Mounting information

## MOUNTING ACCESSORIES

Mounting rail type according to IEC60715/TH35-7.5

Mounting rail type according to IEC60715/G32

Jumper

red

white

blue

Cat. No. X756370

Cat. No. X756894

LCONTLS (1)

(1)

LCONZBUSB (1)

PT100, PT1000,  
potentiometer 0...600k $\Omega$   
Thermocouples types B, C, E, J, K, N, R, S, T  
-200...+2400°C, based on sensor (2)

programmable using FDT/DTM software

2 NA contacts (solid state relay)

30 Vdc / 100 mA

2 yellow LEDs

limit value, window, trend, inversion and memory

24 Vdc (16.8...30 Vdc)

18 mA max. at 24 Vdc

10K/span(K) + 0.2% FS (for PT) / 10K/span(K) + 0.4% FS (for TC)

24 bit

$\pm 0.05\%$  FS (for PT and potentiometer) /  $\pm 0.1\%$  FS (for TC)

<100 ppm/°C

5...500 ms (adjustable, default 30 ms)

2.5 kVac / 60 s (3)

EN 61000-6-2, EN 61000-6-4

IEC 664-1, DIN VDE

III / 2

IP 20 IEC 529 EN60529

-40...+70°C

1.5 mm<sup>2</sup> fixed screw terminal block

PA

40 g

on rails, side by side

PR/3/AC, PR/3/AC/ZB, PR/3/AS, PR/3/AS/ZB

CWBK 7-0802 Cat. No. X766802

CWBK 7-0803 Cat. No. X766803

CWBK 7-0804 Cat. No. X766804

## APPLICATIONS

CWTPR 7-0370 is a "universal" transducer for a wide range of temperature sensors that can be used for precise temperature measurement with the most popular models of temperature sensors on the market.

Measurements can be taken in low and high temperature ranges (e.g. in air conditioners) and in process control. The flexibility of the system allows it to be used from -200 to 1400°C. With resistive sensors, the connection method may be based on 2, 3 or 4 wire technologies. Both input ranges and output thresholds can be changed using FDT/DTM software and a USB interface.

The normally open contacts of the two output thresholds are managed by two solid state relays.

# Programmable temperature sensor converters

- Converters for PT100 sensors
- 3-way galvanic separation
- 8 programmable input ranges
- 3 programmable output ranges
- Simplified programming
- Version with 24-240 Vac/dc power supply

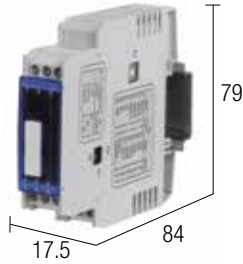

## NOTES

Depth measurements include terminal block and rail clamp clearance.

- (1) Settable using a rotary switch
- (2) Settable using a DIP-switch
- (3) May also be used with the 2-wire PT100, connecting terminal blocks 1 and 4 together
- (4) range 16.8...30 Vdc / 19.2...28.8 Vac
- (5) 3-way, IN/OUT/power supply

## BLOCK DIAGRAM

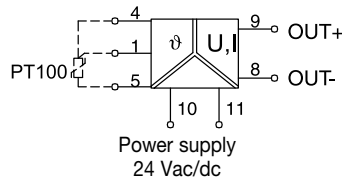

## VERSIONS

Cat. No. X756816

## APPLICATIONS

CWPT 6-0816

## INPUT TECHNICAL DATA

Input signal

Programmable temperatures (1)

Three-wire PT100 (3)

-50...+50°C (-58...+122°F)  
 -50...+100°C (-58...+212°F)  
 -50...+150°C (-58...+302°F)  
 0...+100°C (+32...+212°F)  
 0...+150°C (+32...+302°F)  
 0...+200°C (+32...+392°F)  
 0...+300°C (+32...+572°F)  
 0...+400°C (+32...+752°F)

0.5 mA

Power supply current

## OUTPUT TECHNICAL DATA

Output signal (2)

Applicable load

0...10 V  
 0...20 / 4...20 mA  
 >1 kΩ with voltage output  
 <400 Ω with current output

## GENERAL TECHNICAL DATA

Power supply voltage

Power consumption

Accuracy

Conversion frequency

Temperature coefficient

Isolation

EMC standards

Reference Standards

Overvoltage category / Pollution degree

Protection degree

Operating temperature range

Connection type

Housing material

Approximate weight

Mounting information

24 Vac/dc (4)  
 ≤ 35 mA ± 10% at 24 Vdc  
 <0.3% FS  
 <30 Hz  
 0.015% / K FS  
 1.5 kVac / 60 s (5)  
 EN 50081-2, EN 50082-2  
 IEC 664-1, DIN VDE  
 III / 2  
 IP20  
 -20...+60°C  
 2.5 mm<sup>2</sup> fixed screw terminal blocks  
 UL94V-0 Noryl  
 75 g  
 vertical on rails, side by side

## MOUNTING ACCESSORIES

Mounting rail type according to IEC60715/TH35-7.5

Mounting rail type according to IEC60715/G32

Jumper

(16 poles, 16 A)

red  
 white  
 blue

PR/3/AC, PR/3/AC/ZB, PR/3/AS, PR/3/AS/ZB

# Programmable temperature sensor converters

- Converters for type J and K thermocouple sensors
- 3-way galvanic separation
- 8 programmable input ranges
- 3 programmable output ranges
- Simplified programming
- Version with 24-240 Vac/dc power supply

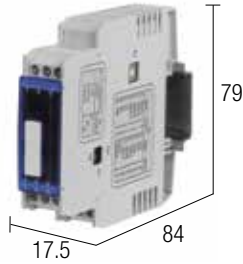

## NOTES

Depth measurements include terminal block and rail clamp clearance.

- (1) Settable using a rotary switch
- (2) Settable using a DIP-switch
- (3) range 16.8...30 Vdc / 19.2...28.8 Vac
- (4) 3-way, IN/OUT/power supply

## BLOCK DIAGRAM

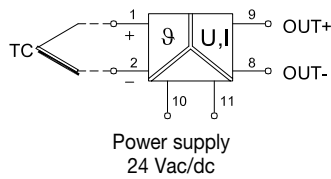

## VERSIONS

Cat. No. X756844

CWTH 6-0844

## APPLICATIONS

The module converts and isolates signals deriving from type J (FeCuNi) or K (NiCrNi) thermocouples into a proportional analogue signal and is programmable in eight input temperature ranges and into the three main standard output signals. Configuration is obtained by setting the DIP-switches located on the side. The converters are galvanically isolated, which ensures more precise signal reading, and can be used both with isolated and non-isolated thermocouples.

## INPUT TECHNICAL DATA

Input signal

FeCuNi (type J) and NiCrNi (type K) thermocouple  
compliant with DIN/IEC584-1  
-50...+200°C (-58...+392°F)  
-50...+350°C (-58...+662°F)  
0...+200°C (+32...+392°F)  
0...+400°C (+32...+752°F)  
0...+600°C (+32...+1112°F)  
0...+800°C (+32...+1472°F)  
0...+1000°C (+32...+1832°F)  
0...+1200°C (+32...+2192°F)

Programmable temperatures (1)

Power supply current

—

## OUTPUT TECHNICAL DATA

Output signal (2)

0...10 V  
0...20 / 4...20 mA  
>1 kΩ with voltage output  
<400 Ω with current output

Applicable load

## GENERAL TECHNICAL DATA

Power supply voltage

24 Vac/dc (3)

Power consumption

≤ 35 mA ± 10% at 24 Vdc

Accuracy

<0.5% FS

Conversion frequency

<30 Hz

Temperature coefficient

0.015% / K FS

Isolation

1.5 kVac / 60 s (4)

EMC standards

EN 50081-2, EN 50082-2

Reference Standards

IEC 664-1, DIN VDE

Overvoltage category / Pollution degree

III / 2

Protection degree

IP20

Operating temperature range

-20...+60°C

Connection type

2.5 mm<sup>2</sup> fixed screw terminal blocks

Housing material

UL94V-0 Noryl

Approximate weight

65 g

Mounting information

vertical on rails, side by side

## MOUNTING ACCESSORIES

Mounting rail type according to IEC60715/TH35-7.5

PR/3/AC, PR/3/AC/ZB, PR/3/AS, PR/3/AS/ZB

Mounting rail type according to IEC60715/G32

Jumper red  
(16 poles, 16 A) white  
blue

# Monitor module for current signal

- For measuring AC currents
- Adjustable threshold value
- With transistor and relay output
- 3 kV Input/Output isolation

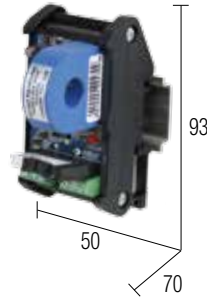

## NOTES

Depth measurements include terminal block and rail clamp clearance.

(1) Isolation refers to non-isolated (bare) measurement conductor in contact with the wall of the toroid. Using isolated conductors, the isolation value of the conductor is added to the isolation value of the converter

## BLOCK DIAGRAM

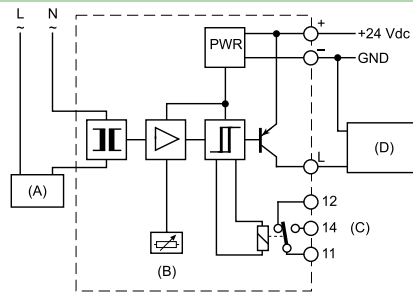

- (A) AC Load
  - (B) Control threshold
  - (C) Exchange output contact
  - (D) Transistor-controlled digital input
- 24 Vac/dc power supply

## VERSIONS

Cat. No. XCCIS2
CCIS-2

## APPLICATIONS

Inserted into a current circuit, the card can be used to set (using a precision potentiometer) the desired current value for the relay or transistor switch, obtaining a current threshold above or below which the switch occurs. The cable carrying the current must be passed through the module's toroidal sensor. The relay or the transistor switches when the set current threshold is surpassed.

## INPUT TECHNICAL DATA

Max. measurement current	50 A (AC)
Max. measurement voltage	600 Vac (1)
Frequency	50...60 Hz
Connection of current conductor	with Ø 13 mm through cable

50 A (AC)
600 Vac (1)
50...60 Hz
with Ø 13 mm through cable

## OUTPUT TECHNICAL DATA

Threshold adjustment	2...40 A
Hysteresis threshold	± 10%
Max. outrush current	100 mA PNP open collector
Output stage	"high" 24 V (transistor) and powered relay with I below the threshold "low" 0 V (transistor) and non-powered relay with I above the threshold
Reaction time	20 ms

2...40 A
± 10%
100 mA PNP open collector
"high" 24 V (transistor) and powered relay with I below the threshold "low" 0 V (transistor) and non-powered relay with I above the threshold
20 ms

## GENERAL TECHNICAL DATA

Power supply voltage	24 Vdc ± 10%
Max. power consumption	100 mA
Operating temperature range	0...60°C
Input/output isolation	> 3 kVac /60 s
Connection type	2.5 mm <sup>2</sup> fixed screw terminal blocks
Housing material	UL94V-03 polyamide
Approximate weight	100 g
Mounting information	vertical on rails, side by side

24 Vdc ± 10%
100 mA
0...60°C
> 3 kVac /60 s
2.5 mm <sup>2</sup> fixed screw terminal blocks
UL94V-03 polyamide
100 g
vertical on rails, side by side

## MOUNTING ACCESSORIES

Mounting rail compliant with IEC60715/TH35	
Mounting rail type according to IEC60715/G32	
Jumper (16 poles, 16 A)	red white blue

PR/3/AC, PR/3/AS
PR/DIN/AC, PR/DIN/AS, PR/DIN/AL
—
—
—

# Current transducer

- For AC and DC current measurements
- Protected from transients
- LED power supply indicator
- 3 programmable output ranges

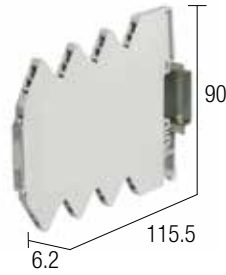

## NOTES

Depth measurements include guide rail and front connector clearance, given together with the product, but not indicated in the photo.

(1) Do not connect directly to a 400 V line

## BLOCK DIAGRAM

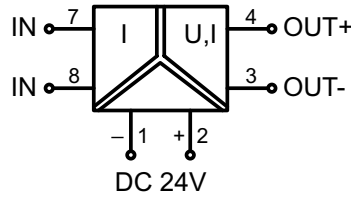

## VERSIONS

- Input 0...1 A
- Input 0...5 A
- Input 0...10 A

Cat. No. X756540	Cat. No. X756541	Cat. No. X756542
------------------	------------------	------------------

WAA 7-0540	WAA 7-0541	WAA 7-0542
------------	------------	------------

## INPUT TECHNICAL DATA

Input signal	0...1 A AC/DC	0...5 A AC/DC	0...10 A AC/DC
Max. input voltage	400 V (1)	400 V (1)	400 V (1)
Connection of current conductor	1.5 mm <sup>2</sup> screw-on terminal block	1.5 mm <sup>2</sup> screw-on terminal block	1.5 mm <sup>2</sup> screw-on terminal block

	VOLTAGE	CURRENT
Output signal	0...10 V	0...20 mA / 4...20 mA
Max. output signal	11 V	21 mA
Applicable load	>1 kΩ	<400 Ω

## OUTPUT TECHNICAL DATA

Output signal	0...10 V	0...20 mA / 4...20 mA
Max. output signal	11 V	21 mA
Applicable load	>1 kΩ	<400 Ω

## GENERAL TECHNICAL DATA

Power supply voltage	24 Vdc (16.8...30 Vdc)	24 Vdc (16.8...30 Vdc)	24 Vdc (16.8...30 Vdc)
Power consumption	13 mA	13 mA	13 mA
Operating temperature range	-25...+60°C	-25...+60°C	-25...+60°C
Linearity error	< 0.1% FS (23°C)	< 0.1% FS (23°C)	< 0.1% FS (23°C)
Offset error	< 0.5% FS (23°C)	< 0.5% FS (23°C)	< 0.5% FS (23°C)
Temperature coefficient	< 150 ppm / K FS	< 150 ppm / K FS	< 150 ppm / K FS
Response time	150 ms	150 ms	150 ms
Protection degree	IP20	IP20	IP20
Connection type	1.5 mm <sup>2</sup> screw-on terminal block	1.5 mm <sup>2</sup> screw-on terminal block	1.5 mm <sup>2</sup> screw-on terminal block
Approximate weight	55 g	55 g	55 g
Mounting information	on rails, side by side	on rails, side by side	on rails, side by side

Power supply voltage	24 Vdc (16.8...30 Vdc)	24 Vdc (16.8...30 Vdc)	24 Vdc (16.8...30 Vdc)
Power consumption	13 mA	13 mA	13 mA
Operating temperature range	-25...+60°C	-25...+60°C	-25...+60°C
Linearity error	< 0.1% FS (23°C)	< 0.1% FS (23°C)	< 0.1% FS (23°C)
Offset error	< 0.5% FS (23°C)	< 0.5% FS (23°C)	< 0.5% FS (23°C)
Temperature coefficient	< 150 ppm / K FS	< 150 ppm / K FS	< 150 ppm / K FS
Response time	150 ms	150 ms	150 ms
Protection degree	IP20	IP20	IP20
Connection type	1.5 mm <sup>2</sup> screw-on terminal block	1.5 mm <sup>2</sup> screw-on terminal block	1.5 mm <sup>2</sup> screw-on terminal block
Approximate weight	55 g	55 g	55 g
Mounting information	on rails, side by side	on rails, side by side	on rails, side by side

## MOUNTING ACCESSORIES

Mounting rail type according to IEC60715/TH35-7.5	
Mounting rail type according to IEC60715/G32	
Jumper (16 poles, 16 A)	red white blue

## PR/3/AC, PR/3/AC/ZB, PR/3/AS, PR/3/AS/ZB

CWBK 7-0802 Cat. No. X766802	
CWBK 7-0803 Cat. No. X766803	
CWBK 7-0804 Cat. No. X766804	

## APPLICATIONS

Used for measuring an AC or DC current value by means of a "HALL" sensor. The presence of current in a circuit indicates not only that voltage is present, but that the circuit is closed and the load connected is active, as well as indicating the operating conditions of the control circuit. The module guarantees galvanic separation between the current conductor and the analogue output.

● → Switch On	S1				
Input	Output 1 2 3 4				
0-1A	0-10V				
0-1A	0-20mA	●			
0-1A	4-20mA	●			

Range WAA7-0540

● → Switch On	S1				
Input	Output 1 2 3 4				
0-5A	0-10V				
0-5A	0-20mA	●			
0-5A	4-20mA	●			

Range WAA7-0541

● → Switch On	S1				
Input	Output 1 2 3 4				
0-10A	0-10V				
0-10A	0-20mA	●			
0-10A	4-20mA	●			

Range WAA7-0542

# Current / analogue converters

- For AC and DC current measurements
- Protected from transients
- LED power supply indicator
- Three available output signals

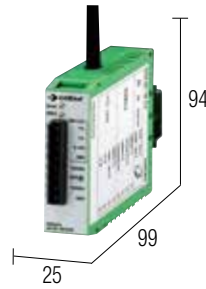

Item available until supplies last

## NOTES

Depth measurements include guide rail and front connector clearance, given together with the product, but not indicated in the photo.

## BLOCK DIAGRAM

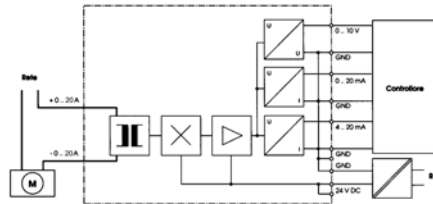

## VERSIONS

Input 0...20 A  
Input 0...50 A

## Cat. No. XW000932

-  
SW50VA

## APPLICATIONS

Used for measuring an AC or DC current value by means of a "HALL" sensor. The presence of current in a circuit indicates not only that voltage is present, but that the circuit is closed and the load connected is active, as well as indicating the operating conditions of the control circuit. The module guarantees galvanic separation between current conductor and analogue output and, since it is not connected in series to the controlled current, it cannot be damaged by overcurrents or short-circuits.

## INPUT TECHNICAL DATA

Input signal  
Max. input voltage  
Connection of current conductor

0...50 A AC/DC  
380 V  
with Ø 8 mm through cable

## OUTPUT TECHNICAL DATA

Output signal  
Max. output signal  
Applicable load

VOLTAGE	CURRENT
0...10 V	0...20 mA / 4...20 mA
11 V	22 mA
>2 kΩ	<500 Ω

## GENERAL TECHNICAL DATA

Power supply voltage  
Power consumption  
Operating temperature range  
Linearity error  
Offset error  
Amplification error  
Temperature coefficient  
Transistor immunity  
Response time  
Protection degree  
Connection type  
Approximate weight  
Mounting information

24 Vdc ± 10%  
60 mA  
0...55°C  
< 0.5%  
< 0.5%  
< 0.2%  
< 0.02%/K  
200 V  
10 mS  
IP20  
2.5 mm<sup>2</sup> removable screw terminal blocks  
100 g  
vertical on rails, side by side

## MOUNTING ACCESSORIES

Mounting rail compliant with IEC60715/TH35  
Mounting rail type according to IEC60715/G32  
Jumper  
(16 poles, 16 A)

PR/3/AC, PR/3/AS  
PR/DIN/AC, PR/DIN/AS, PR/DIN/AL  
—  
—  
—



# Frequency / analogue programmable converters

- Programmable frequency range 0...28.8 KHz
- 3 programmable analogue output signal ranges
- 2.5 kV 3-way input/output isolation

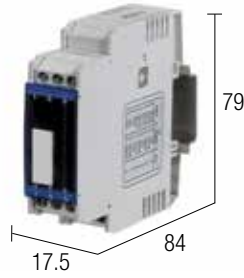

## NOTES

Depth measurements include terminal block and rail clamp clearance.

- (1) range 16.8...30 Vdc / 19.2...28.8 Vac  
 (2) 3 way, IN/OUT/power supply

## BLOCK DIAGRAM

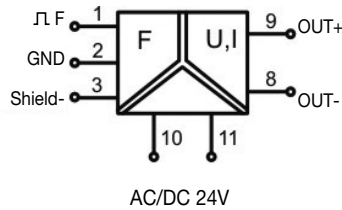

## VERSIONS

Cat. No. X756524

CWNFA 6-0524

## INPUT TECHNICAL DATA

Input signal (range)	0...28.8 kHz settable by DIP switch
Signal type	AC/DC 0.6...30 Vpp
Input resistance	50 kΩ
Hysteresis	0.5 Vpp or 5 Vpp settable by DIP switch

## OUTPUT TECHNICAL DATA

Output signal	0...10 V, (max. 10.6 V)
Applicable load	0...20 / 4...20 mA, (max 21 mA)
Ripple	>1 kΩ with voltage output <400 Ω with current output < 5 mVeff

## GENERAL TECHNICAL DATA

Power supply voltage	24 Vac/dc (1)
Power consumption	20 mA
Accuracy	0.1 FS (23°C)
Linearity error	0.02%
Ripple	0.1%
Setting time (1% precision)	200 ms
Temperature coefficient	70 ppm/K
Isolation	1.5 kVac / 60 s (2)
EMC standards	EN 61000-6-2, EN 61000-6-4
Reference Standards	IED 664-1, DIN VDE
Surge category	III
Degree of pollution	2
Protection degree	IP 20 IEC 529 EN60529
Operating temperature range	-25...+60°C
Connection type	1.5 mm <sup>2</sup> fixed screw terminal blocks
Housing material	PPE
Approximate weight	70 g
Mounting information	vertical on rails, side by side

## MOUNTING ACCESSORIES

Mounting rail type according to IEC60715/TH35-7.5	PR/3/AC, PR/3/AC/ZB, PR/3/AS, PR/3/AS/ZB
Mounting rail type according to IEC60715/G32	—
Jumper	red — white — blue —

## APPLICATIONS

This module is used to convert a sinusoid or rectangular frequency signal into a standard analogue signal (e.g. 0...10 V, 0...20 mA or 4...20 mA). A microprocessor detects the signal and calculates the output value, ensuring extremely high precision and stability. Measurement range is set using a DIP switch: the device offers 64 calibrated ranges from 0...100 Hz to 0...28.8 kHz.

S2 ● → Switch On														
Range*	1	2	3	4	5	6	8	Range*	1	2	3	4	5	6
0-100Hz	●	●	●	●	●	●	●	0-5kHz	●	●	●	●	●	●
0-200Hz	●	●	●	●	●	●	●	0-6kHz	●	●	●	●	●	●
0-250Hz	●	●	●	●	●	●	●	0-8kHz	●	●	●	●	●	●
0-400Hz	●	●	●	●	●	●	●	0-10kHz	●	●	●	●	●	●
0-500Hz	●	●	●	●	●	●	●	0-12kHz	●	●	●	●	●	●
0-750Hz	●	●	●	●	●	●	●	0-16kHz	●	●	●	●	●	●
0-1kHz	●	●	●	●	●	●	●	0-20kHz	●	●	●	●	●	●
0-1.5kHz	●	●	●	●	●	●	●	0-24kHz	●	●	●	●	●	●
0-2kHz	●	●	●	●	●	●	●	0-28.8kHz	●	●	●	●	●	●
0-2.5kHz	●	●	●	●	●	●	●							
0-3kHz	●	●	●	●	●	●	●							
0-4kHz	●	●	●	●	●	●	●							
Hysteresis	0.5Vpp						5Vpp							

● → Switch On	S1
Output	1 2 3
0-10V	●
0-20mA	●
4-20mA	●

# Auxiliary power supply for sensors and potentiometers

- Stabilised switching converter
- IN 16.8...20 Vdc / 9...11 Vdc 60 mA
- Suitable for powering potentiometers and sensors

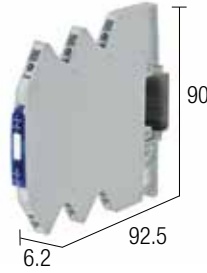

## NOTES

Depth measurements include terminal block and rail clamp clearance.  
(1) range 16.8...30 Vdc

## BLOCK DIAGRAM

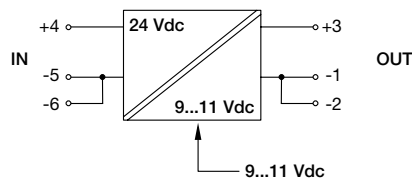

## APPLICATION EXAMPLES

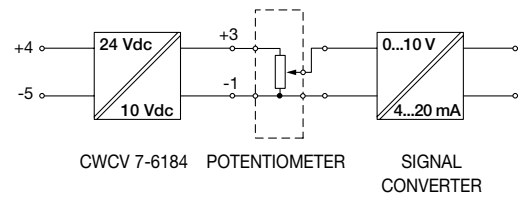

## VERSIONS

- With screw connection (standard)
- With spring connection

Cat. No. X766184

CWCV 7-6184

## INPUT TECHNICAL DATA

Nominal voltage	24 Vdc (1)
Current with max lout	30 mA at 10 Vdc
Safety fuse	T 1 A (external)

## OUTPUT TECHNICAL DATA

Voltage	10 Vdc (9...11 Vdc adjustable)
Maximum current	60 mA
Permanent current	60 mA
Load regulation	< 1%
Ripple at nominal U-I	≤ 50 mVpp
Protection against short circuit/overload	yes
Output signal	Yellow LED Power OK
Parallel connection	possible with external diode

## GENERAL TECHNICAL DATA

Operating temperature range	-25...+60°C
Input/output isolation	50 Vac / 60 s
Protection degree	IP 20 IEC529, EN60529
Electromagnetic compatibility	EN 50081-1, EN 50082-2, EN 61000-3-2
Transistor immunity	EN61000-4-2, EN61000-4-4
Connection type	1.5 mm <sup>2</sup> screw/1.5 mm <sup>2</sup> spring
Housing material	UL94V-0 Noryl
Approximate weight	35 g
Mounting information	vertical on rails, side by side

## MOUNTING ACCESSORIES

Mounting rail type according to IEC60715/TH35-7.5	<b>PR/3/AC, PR/3/AC/ZB, PR/3/AS, PR/3/AS/ZB</b>
Mounting rail type according to IEC60715/G32	—
Jumper	red white blue
	CWBK 7-0802 Cat. No. X766802 CWBK 7-0803 Cat. No. X766803 CWBK 7-0804 Cat. No. X766804

## APPLICATIONS

A constant voltage is often required in process control in order to supply power or reference values. A constant voltage source is very often used in digital technology, especially with analogue position sensors (linear potentiometers). This is due to their extremely economical and effective measurements of absolute position, routes, angles and thicknesses. Moreover, the linear potentiometer requires only one continuous voltage and one analogue control or position indicator input.

# Signal inverters NPN and PNP

- Converts NPN sensors to PNP and vice versa
- Reduced overall dimensions

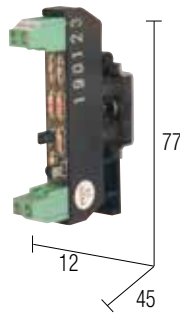

## NOTES

(1) range 17...30 Vdc

## BLOCK DIAGRAM

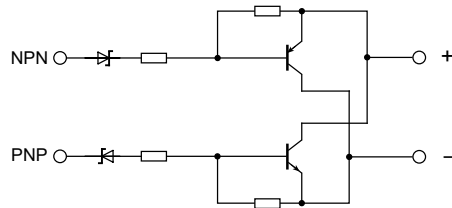

## VERSIONS

Cat. No. XNPNPNP  
CI-NPN/PNP

## APPLICATIONS

Converts PNP sensor signals to NPN and vice versa. It is able to adapt all sensors on the market to any PLC input regardless of output polarity, and it is highly useful in maintenance operations where the correct replacement sensor is unavailable.

## INPUT TECHNICAL DATA

Input voltage	24 Vdc (1)
Max. current	200 mA
Max. frequency	120 kHz

## GENERAL TECHNICAL DATA

Current set to OFF	—
EMC standards	EN 61000-6-2, EN 61000-6-4
Reference Standards	IEC 664-1, DIN VDE
Surge category	II
Degree of pollution	2
Protection degree	IP 20 IEC 529 EN60529
Operating temperature range	0...55°C
Connection type	2.5 mm <sup>2</sup> fixed screw terminal blocks
Housing material	UL94V-0 polyamide
Approximate weight	20 g
Mounting information	vertical on rails, side by side

## MOUNTING ACCESSORIES

Mounting rail type according to IEC60715/TH35-7.5	PR/3/AC, PR/3/AS
Mounting rail type according to IEC60715/G32	PR/DIN/AC - PR/DIN/AS - PR/DIN/AL
Jumper	red — white — blue —

## CONNECTION EXAMPLES

Conversion from PNP to NPN

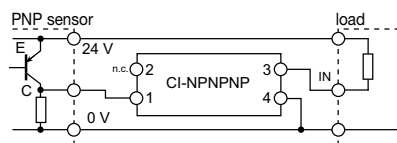

Conversion from NPN to PNP

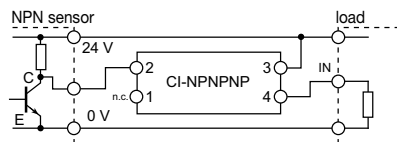

# Single relay modules quick selection table

These tables are used for quickly identifying items and verifying whether all of the product's technical details satisfy the set requirements.

Number of relays	Input rated voltage	Output		Notes	Type	Cat. No.	Page
		type/no. of contacts	contact current				
1	12 Vdc	1 SC	10A	(1)	CM1C012	XCM1C012	88
1	12 Vdc	2 SC	5A	(1)	CM2C012	XCM2C012	89
1	12 Vac	1 SC	10A	(1)	CM1A012	XCM1A012	91
1	12 Vac	2 SC	5A	(1)	CM2A012	XCM2A012	92
1	12 Vac/dc	1 SC	6A	(1)	CWRE7-0848	X766848	95
1	24 Vdc	1 NA	5A	(2)	RFA024D	XRFA024D	86
1	24 Vdc	1 SC	16A	(1)	RE1024D	XRE1024D	86
1	24 Vdc	1 SC	16A	(2)	RF1024D	XRF1024D	86
1	24 Vdc	1 SC	12A	(1)	CM1C024	XCM1C024	88
1	24 Vdc	1 SC	12A	(1)	RE1824D	XRE1824D	86
1	24 Vdc	1 SC	12A	(2)	RF1824D	XRF1824D	86
1	24 Vdc	2 SC	8A	(1)	CM2C024	XCM2C024	89
1	24 Vdc	4 SC	3A	(1)	CM4C024	XCM4C024	90
1	24 Vac/dc	1 SC	6A	(1)	CWRE7-0842	X766842	95
1	24 Vac/dc	1 SC	6A	(2) (3)	CKR16	XCKR16	94
1	24 Vac/dc	2 SC	8A	(1)	RE2024D	XRE2024D	87
2	24 Vac/dc	2 NA	5A	(2)	CKR25	XCKR25	94
1	24 Vac	1 SC	12A	(1)	CM1A024	XCM1A024	91
1	24 Vac	2 SC	8A	(1)	CM2A024	XCM2A024	92
1	48 Vdc	1 SC	10A	(1)	CM1C048	XCM1C048	88
1	48 Vdc	2 SC	5A	(1)	CM2C048	XCM2C048	89
1	48 Vac/dc	1 SC	6A	(1)	CWRE7-0845	X766845	95
1	110 Vdc	1 SC	10A	(1)	CM1C110	XCM1C110	88
1	110 Vdc	2 SC	5A	(1)	CM2C110	XCM2C110	89
1	110...120 Vac/dc	1 SC	6A	(1)	CWRE7-0846	X766846	95
1	120 Vac	1 SC	10A	(1)	CM1A120	XCM1A120	91
1	120 Vac	2 SC	5A	(1)	CM2A120	XCM2A120	92
1	230 Vac	1 SC	6A	(1)	CWRE7-0847	X766847	95
1	230 Vac	1 SC	10A	(1)	CM1A230	XCM1A230	91
1	230 Vac	2 SC	5A	(1)	CM2A230	XCM2A230	92

## Notes

- (1) version with pluggable relay
- (2) version with fixed relay
- (3) safety fuse on contact
- (4) no light alarm and protection diode

# Single relay modules R series

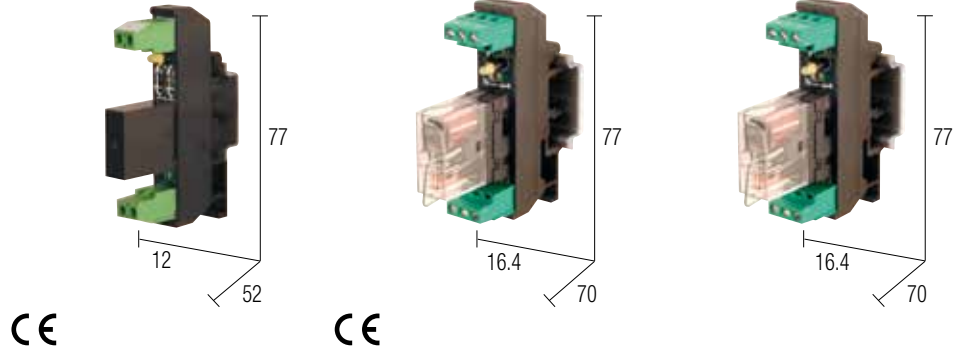

## NOTES

- (1) Relay make and model are not final and may be replaced without notice. The technical details shown are to be considered typical.
- (2) Version made to order (not kept in stock); contact our sales office for availability.

## BLOCK DIAGRAM

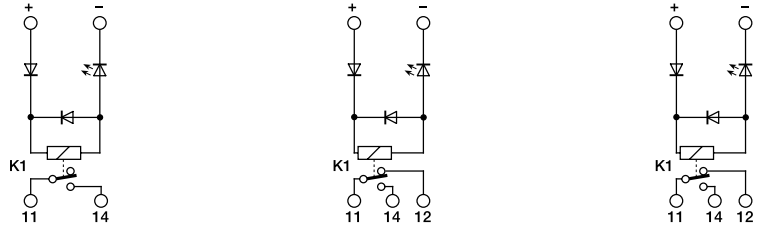

## VERSIONS

Pluggable relay  
Fixed relay

Cat. No. XRFA024D

Cat. No. XR\_1824D

Cat. No. XR\_1024D

—  
RFA024D (2)

RE1824D  
RF1824D

RE1024D  
RF1024D (2)

## INPUT TECHNICAL DATA

Nominal voltage  
Power consumption (1 channel)  
Turn ON time  
Turn OFF time  
Protection circuit

**24 Vdc ± 10%**  
15 mA ± 10%  
15 ms  
5 ms  
damping diode

**24 Vdc ± 10%**  
22 mA ± 10%  
15 ms  
5 ms  
damping diode

**24 Vdc ± 10%**  
27 mA ± 10%  
15 ms  
5 ms  
damping diode

## OUTPUT TECHNICAL DATA

Contact type  
Nominal current (resistive load)  
Max. cut-off capacity  
Max. fuse current

1 NA AgSnO<sub>2</sub>  
5 A / 250 Vac  
**5 A**  
—

1 exchange AgSnO<sub>2</sub>  
12 A / 250 Vac  
**12 A**  
—

1 exchange AgSnO<sub>2</sub>  
16 A / 250 Vac  
**16 A**  
—

## GENERAL TECHNICAL DATA

Operating temperature range  
Coil isolation / contacts  
Isolation between output terminal blocks  
Protection degree  
Overvoltage category / Pollution degree  
Reference Standards  
Power/status indicator  
Connection type

−10...+50°C  
2.5 kVac / 60 s  
0.5 kVac / 60 s (between open contact poles)  
IP 00 IEC529, EN60529  
III / 2  
IEC 664-1, DIN VDE 0110.1  
Green LED  
AWG26-14 2.5 mm<sup>2</sup> screw clamp terminal blocks

−10...+50°C  
2.5 kVac / 60 s  
0.5 kVac / 60 s (between open contact poles)  
IP 00 IEC529, EN60529  
III / 2  
IEC 664-1, DIN VDE 0110.1  
Green LED  
AWG26-14 2.5 mm<sup>2</sup> screw clamp terminal blocks

−10...+50°C  
2.5 kVac / 60 s  
0.5 kVac / 60 s (between open contact poles)  
IP 00 IEC529, EN60529  
III / 2  
IEC 664-1, DIN VDE 0110.1  
Green LED  
AWG26-14 2.5 mm<sup>2</sup> screw clamp terminal blocks

Housing material  
Approximate weight  
Mounting information

UL94V-0 plastic  
30 g  
on rails, side by side

UL94V-0 plastic  
44 g  
on rails, side by side

UL94V-0 plastic  
44 g  
on rails, side by side

## MOUNTING ACCESSORIES

Mounting rail compliant with IEC60715/TH35  
Mounting rail type according to IEC60715/G32

**PR/3/AC, PR/3/AC/ZB, PR/3/AS, PR/3/AS/ZB  
PR/DIN/AC - PR/DIN/AS - PR/DIN/AL**

Spare part relay (1)  
Jumper black

Cat. No. 8904000  
—

Cat. No. 8904001  
—

Cat. No. 8904058  
—

# Single relay modules R series

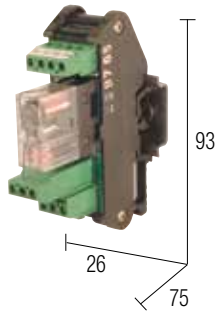

## NOTES

- (1) Relay make and model are not final and may be replaced without notice. The technical details shown are to be considered typical.
- (2) Product made to order (not kept in stock).

## BLOCK DIAGRAM

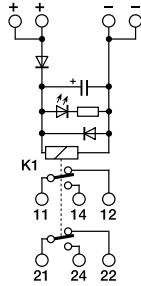

## VERSIONS

Pluggable relay  
Fixed relay

Cat. No. XRE2024D

RE2024D

-

## INPUT TECHNICAL DATA

Nominal voltage  
Power consumption (1 channel)  
Turn ON time  
Turn OFF time  
Protection circuit

**24 Vac / dc ± 10%**  
22 mA ± 10%  
15 ms  
5 ms  
damping diode

## OUTPUT TECHNICAL DATA

Contact type  
Nominal current (resistive load)  
Max. cut-off capacity  
Max. fuse current

2 exchanges AgSnO<sub>2</sub>  
8 A / 250 Vac  
**8 A**  
—

## GENERAL TECHNICAL DATA

Operating temperature range  
Coil isolation / contacts  
Isolation between output terminal blocks  
Protection degree  
Overvoltage category / Pollution degree  
Reference Standards  
Power/status indicator  
Connection type

-10...+50°C  
2.5 kVac / 60 s  
0.5 kVac / 60 s (between open contact poles)  
IP 00 IEC529, EN60529  
III / 2  
IEC 664-1, DIN VDE 0110.1  
Green LED  
AWG26-14 2.5 mm<sup>2</sup> screw clamp terminal blocks

Housing material  
Approximate weight  
Mounting information

UL94V-0 plastic  
76 g  
on rails, side by side

## MOUNTING ACCESSORIES

Mounting rail compliant with IEC60715/TH35  
Mounting rail type according to IEC60715/G32

**PR/3/AC, PR/3/AC/ZB, PR/3/AS, PR/3/AS/ZB**  
**PR/DIN/AC - PR/DIN/AS - PR/DIN/AL**

Spare part relay (1)  
Jumper black

Cat. No. 8904002

—



# Single relay modules CM series

- Pluggable relay
- Installation on omega rail or panel using centre screw
- Compact dimensions
- Cross and slotted screw
- Available plug-in jumper for potential distribution

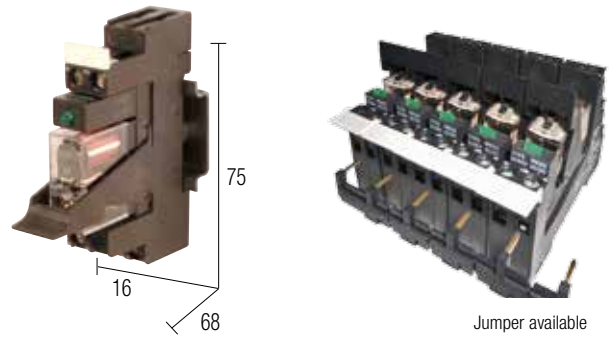

## NOTES

Measurements include rail clamp clearance.

- (1) Relay make and model are not final and may be replaced without notice. The technical details shown are to be considered typical.
- (2) Versions without indicators or safety circuits are available upon request; to order, add the suffix "Z" to the Cat. No. (e.g. XCM1C024Z).
- (3) Gold contact versions are available upon request; to order, add the suffix "U" to the Cat. No. (e.g. XCM1C024U).

## BLOCK DIAGRAM

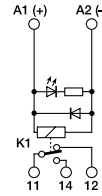

## VERSIONS

- 12 Vdc
- 24 Vdc
- 48 Vdc
- 110 Vdc

## INPUT TECHNICAL DATA

	Cat. No. XCM1C012	Cat. No. XCM1C024	Cat. No. XCM1C048	Cat. No. XCM1C110
Nominal voltage	12 Vdc ±10%	24 Vdc ±10%	48 Vdc ±10%	110 Vdc ±10%
Power consumption (1 channel)	44 mA ±10%	22 mA ±10%	12 mA ±10%	11 mA ±10%
Turn ON time	15 ms	15 ms	15 ms	15 ms
Turn OFF time	5 ms	5 ms	5 ms	20 ms
Protection circuit	damping diode		(2)	

## OUTPUT TECHNICAL DATA

Contact type	1 exchange AgSnO <sub>2</sub> (3)			
Nominal current (resistive load)	12 A / 250 Vac			
Max. cut-off capacity	12 A			
Max. fuse current	—			

## GENERAL TECHNICAL DATA

Operating temperature range	-10...+50°C			
Coil isolation / contacts	4 kVac / 60 s			
Isolation between output terminal blocks	1 kVac / 60 s (between open contact poles)			
Protection degree	IP 20 IEC 529, EN60529			
Overvoltage category / Pollution degree	III / 2			
Reference Standards	IEC 664-1, DIN VDE 0110.1			
Power/status indicator	Green LED (2)			
Connection type	AWG26-14 2.5 mm <sup>2</sup> screw clamp terminal blocks			
Housing material	UL94V-0 plastic			
Approximate weight	54 g			
Mounting information	rail, side by side or panel using centre screw			

## MOUNTING ACCESSORIES

	PR/3/AC, PR/3/AC/ZB, PR/3/AS, PR/3/AS/ZB			
Mounting rail type according to IEC60715/TH35-7.5	—			
Mounting rail type according to IEC60715/G32	—			
Spare part relay	(1) Cat. No. 8904039	Cat. No. 8904001	Cat. No. 8904008	Cat. No. 8904047
Jumper	black	Cat. No. XCMB16B	—	—
	white	—	—	—
	blue	—	—	—



Jumper

# Single relay modules CM series

- Pluggable relay
- Installation on omega rail or panel using centre screw
- Compact dimensions
- Cross and slotted screw
- Available plug-in jumper for potential distribution

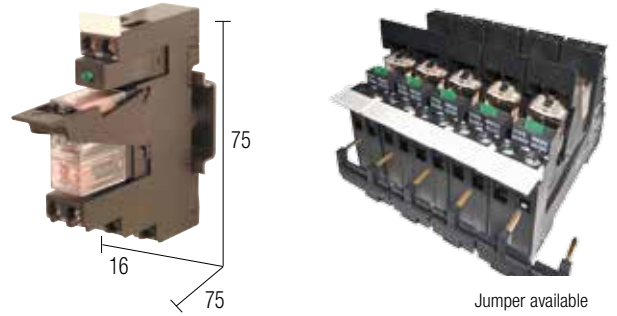

CE

Jumper available

## NOTES

Measurements include rail clamp clearance.

(1) Relay make and model are not final and may be replaced without notice. The technical details shown are to be considered typical.

## BLOCK DIAGRAM

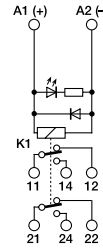

## VERSIONS

12 Vdc  
24 Vdc  
48 Vdc  
110 Vdc

Cat. No. XCM2C012	Cat. No. XCM2C024	Cat. No. XCM2C048	Cat. No. XCM2C110
CM2C012	CM2C024	CM2C048	CM2C0110

## INPUT TECHNICAL DATA

	12 Vdc ±10%	24 Vdc ±10%	48 Vdc ±10%	110 Vdc ±10%
Nominal voltage	12 Vdc ±10%	24 Vdc ±10%	48 Vdc ±10%	110 Vdc ±10%
Power consumption (1 channel)	44 mA ±10%	22 mA ±10%	24 mA ±10%	11 mA ±10%
Turn ON time	15 ms	15 ms	15 ms	15 ms
Turn OFF time	5 ms	5 ms	5 ms	20 ms
Protection circuit	damping diode			

## OUTPUT TECHNICAL DATA

Contact type	2 exchanges AgSnO <sub>2</sub>
Nominal current (resistive load)	8 A / 250 Vac
Max. cut-off capacity	8 A
Max. fuse current	—

## GENERAL TECHNICAL DATA

Operating temperature range	-10...+50°C
Coil isolation / contacts	4 kVac / 60 s
Isolation between output terminal blocks	1 kVac / 60 s (between open contact poles)
Protection degree	IP 20 IEC 529, EN60529
Overvoltage category / Pollution degree	III / 2
Reference Standards	IEC 664-1, DIN VDE 0110.1
Power/status indicator	Green LED
Connection type	AWG26-14 2.5 mm <sup>2</sup> screw clamp terminal blocks
Housing material	UL94V-0 plastic
Approximate weight	67 g
Mounting information	rail, side by side or panel using centre screw

## MOUNTING ACCESSORIES

	PR/3/AC, PR/3/AC/ZB, PR/3/AS, PR/3/AS/ZB
Mounting rail type according to IEC60715/TH35-7.5	—
Mounting rail type according to IEC60715/G32	—
Spare part relay	(1) Cat. No. 8904040   Cat. No. 8904002   Cat. No. 8904009   Cat. No. 8904054
Jumper	Cat. No. XCMB16B   —   —



Jumper

# Single relay modules

## CM series

- Pluggable relay
- Installation on omega rail or panel using centre screw
- Compact dimensions
- Cross and slotted screw
- Available plug-in jumper for potential distribution

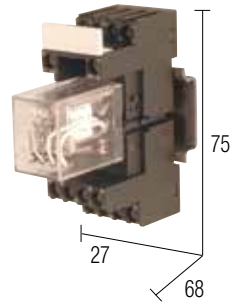

### NOTES

Measurements include rail clamp clearance.

(1) Relay make and model are not final and may be replaced without notice. The technical details shown are to be considered typical

### BLOCK DIAGRAM

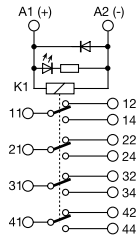

### VERSIONS

- 12 Vdc
- 24 Vdc
- 48 Vdc
- 110 Vdc

Cat. No. XCM4C024

CM4C024

### INPUT TECHNICAL DATA

- Nominal voltage
- Power consumption (1 channel)
- Turn ON time
- Turn OFF time
- Protection circuit

24 Vdc  $\pm 10\%$   
38 mA  $\pm 10\%$   
20 ms  
20 ms

damping diode

### OUTPUT TECHNICAL DATA

- Contact type
- Nominal current (resistive load)
- Max. cut-off capacity
- Max. fuse current

4 exchanges AgSnO<sub>2</sub>  
3 A / 250 Vac  
**3 A**  
—

### GENERAL TECHNICAL DATA

- Operating temperature range
- Coil isolation / contacts
- Isolation between output terminal blocks
- Protection degree
- Overvoltage category / Pollution degree
- Reference Standards
- Power/status indicator
- Connection type
- Housing material
- Approximate weight
- Mounting information

−10...+50°C  
4 kVac / 60 s  
1 kVac / 60 s (between open contact poles)  
IP 20 IEC 529, EN60529  
III / 2  
IEC 664-1, DIN VDE 0110.1  
Green LED  
AWG26-14 2.5 mm<sup>2</sup> screw clamp terminal blocks  
UL94V-0 plastic  
rail, side by side or panel using centre screw

### MOUNTING ACCESSORIES

- Mounting rail type according to IEC60715/TH35-7.5
- Mounting rail type according to IEC60715/G32

PR/3/AC, PR/3/AC/ZB, PR/3/AS, PR/3/AS/ZB

- Spare part relay (1)
- Jumper black
- white
- blue

Cat. No. 8904030

Cat. No. XCMB27B



Jumper

# Single relay modules CM series

- Pluggable relay
- Installation on omega rail or panel using centre screw
- Compact dimensions
- Cross and slotted screw
- Available plug-in jumper for potential distribution

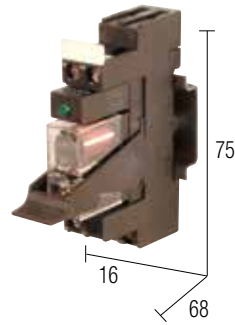

Jumper available



## NOTES

Measurements include rail clamp clearance.

- (1) Relay make and model are not final and may be replaced without notice. The technical details shown are to be considered typical
- (2) Version made to order (not kept in stock); contact our sales office for availability.

## BLOCK DIAGRAM

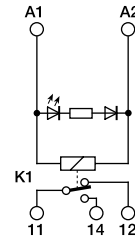

## VERSIONS

- 12 Vdc
- 24 Vdc
- 120 Vdc
- 230 Vdc

Cat. No. XCM1A012	Cat. No. XCM1A024	Cat. No. XCM1A120	Cat. No. XCM1A230
CM1A012 (2)	CM1A024	CM1A120 (2)	CM1A230

## INPUT TECHNICAL DATA

	12 Vac ±10%	24 Vac ±10%	120 Vac ±10%	230 Vac ±10%
Nominal voltage	12 Vac ±10%	24 Vac ±10%	120 Vac ±10%	230 Vac ±10%
Power consumption (1 channel)	95 mA ±10%	48 mA ±10%	10.5 mA ±10%	6 mA ±10%
Turn ON time	15 ms	15 ms	15 ms	15 ms
Turn OFF time	10 ms	10 ms	10 ms	10 ms
Protection circuit	—			

## OUTPUT TECHNICAL DATA

Contact type	1 exchange AgSnO <sub>2</sub>
Nominal current (resistive load)	12 A / 250 Vac
Max. cut-off capacity	12 A
Max. fuse current	—

## GENERAL TECHNICAL DATA

Operating temperature range	-10...+50°C
Coil isolation / contacts	4 kVac / 60 s
Isolation between output terminal blocks	1 kVac / 60 s (between open contact poles)
Protection degree	IP 20 IEC 529, EN60529
Overvoltage category / Pollution degree	III / 2
Reference Standards	IEC 664-1, DIN VDE 0110.1
Power/status indicator	Green LED
Connection type	AWG26-14 2.5 mm <sup>2</sup> screw clamp terminal blocks
Housing material	UL94V-0 plastic
Approximate weight	54 g
Mounting information	rail, side by side or panel using centre screw

## MOUNTING ACCESSORIES

	PR/3/AC, PR/3/AC/ZB, PR/3/AS, PR/3/AS/ZB			
Mounting rail type according to IEC60715/TH35-7.5	—			
Mounting rail type according to IEC60715/G32	—			
Spare part relay	(1) Cat. No. 8904016	Cat. No. 8904048	Cat. No. 8904049	Cat. No. 8904050
Jumper	black	XCMB16B	—	—
	white	—	—	—
	blue	—	—	—



Jumper

# Single relay modules CM series

- Pluggable relay
- Installation on omega rail or panel using centre screw
- Compact dimensions
- Cross and slotted screw
- Available plug-in jumper for potential distribution

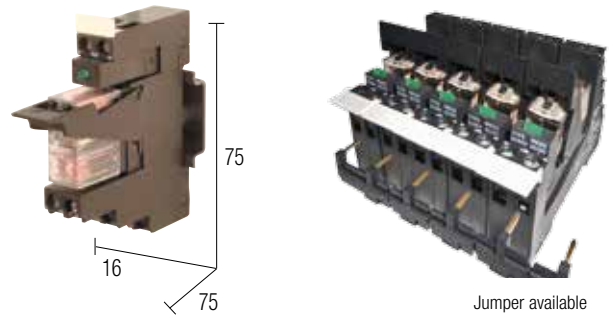

## NOTES

Measurements include rail clamp clearance.

- (1) Relay make and model are not final and may be replaced without notice. The technical details shown are to be considered typical.
- (2) Version made to order (not kept in stock); contact our sales office for availability.

## BLOCK DIAGRAM

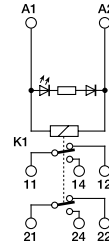

## VERSIONS

12 Vac
24 Vac
120 Vac
230 Vac

Cat. No. XCM2A012	Cat. No. XCM2A024	Cat. No. XCM2A120	Cat. No. XCM2A230
CM2A012 (2)	CM2A024	CM2A120 (2)	CM2A230

## INPUT TECHNICAL DATA

Nominal voltage
Power consumption (1 channel)
Turn ON time
Turn OFF time
Protection circuit

12 Vac $\pm 10\%$	24 Vac $\pm 10\%$	120 Vac $\pm 10\%$	230 Vac $\pm 10\%$
95 mA $\pm 10\%$	48 mA $\pm 10\%$	10.5 mA $\pm 10\%$	6 mA $\pm 10\%$
15 ms	15 ms	15 ms	15 ms
10 ms	10 ms	10 ms	10 ms
		—	

## OUTPUT TECHNICAL DATA

Contact type
Nominal current (resistive load)
Max. cut-off capacity
Max. fuse current

2 exchanges AgSnO <sub>2</sub>
8 A / 250 Vac
<b>8 A</b>
—

## GENERAL TECHNICAL DATA

Operating temperature range
Coil isolation / contacts
Isolation between output terminal blocks
Protection degree
Overvoltage category / Pollution degree
Reference Standards
Power/status indicator
Connection type
Housing material
Approximate weight
Mounting information

-10...+50°C
4 kVac / 60 s
1 kVac / 60 s (between open contact poles)
IP 20 IEC 529, EN60529
III / 2
IEC 664-1, DIN VDE 0110.1
Green LED
AWG26-14 2.5 mm <sup>2</sup> screw clamp terminal blocks
UL94V-0 plastic
67 g
rail, side by side or panel using centre screw

## MOUNTING ACCESSORIES

Mounting rail type according to IEC60715/TH35-7.5
Mounting rail type according to IEC60715/G32
Spare part relay
Jumper

PR/3/AC, PR/3/AC/ZB, PR/3/AS, PR/3/AS/ZB			
Cat. No. 8904017	Cat. No. 8904055	Cat. No. 8904056	Cat. No. 8904057
	Cat. No. XCMB16B		



Jumper

## “CK” series interface system

This series of automation interfaces comprises a range of electromechanical relay modules, solid state relays and passive interfaces in modular cases just 6 mm thick.

All of these products are housed in the new CK module (also available as a component holder module) which, with its 6 2.5 mm<sup>2</sup> spring terminal blocks and 4 contacts for insertion of the innovative “easy bridge”, makes it possible to create different, effective compositions with a significant saving in terms of space and time.

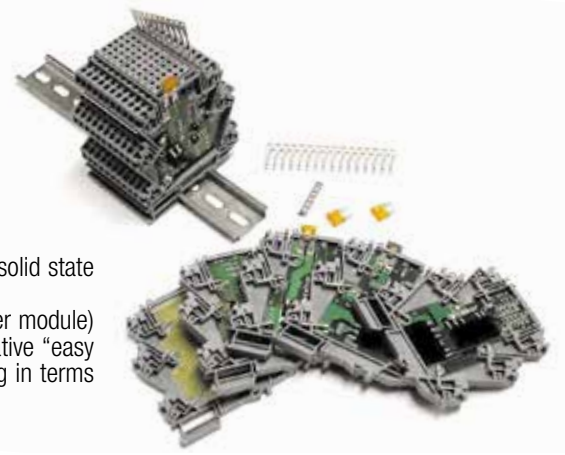

### The range currently comprises a series of products which can all be assembled together:

- Individual electromechanical relays with a single 6 A exchange protected by a replaceable fuse, frontal status LED, AC/DC input and positive or negative coil common.
- Double electromechanical relays with a 5 A NO contact, frontal status LED, AC/DC input and positive or negative coil common.
- Individual solid state relays for 5 A negative common loads protected by a replaceable fuse, frontal status LED and positive or negative input common.
- Double solid state relays for 12-24 Vdc 2.5 A negative common loads with frontal status LED and positive or negative input common.
- Cards with feed-through diode or common anode or cathode.
- Lamp testing modules.
- Distribution modules for common indication and distribution via PTC/CK/42 jumper.

### How to create an interface with the CK system:

- Mount the selected relay modules onto the rail.
- THE **common input and output power supply potentials can be interconnected using PTC/CK/42 quick connector jumpers.**
- For the power supply to relay module inputs and outputs, it is advised to use the **CKF-** module which allows for connection using 24 A spring terminal blocks (2.5mm<sup>2</sup>, AWG26-14), distributing the power to the inputs and outputs of the adjacent modules using quick connection jumpers; the CTF- module may be mounted as the primary module or in a central position in order to divide the current in the jumper into two branches, reducing voltage drops and heating; the CTF- is available with an LED voltage indicator on the input and output for different voltages.
- THE final module must always be protected with the **CK/PT** terminal wall to ensure protection degree IP20.
- Each relay module comes with technical data sheets and a connection diagram; terminal blocks may be marked with NU0851 series tags, to be applied with a pen, plotter or with the Cabur Jet printer.
- Relay input/output power supply cables can be connected directly to relay terminal blocks, connecting two cables (power supply and load input) with a cross section of less than 2.5mm<sup>2</sup> into one terminal block, which reduces the applicable current and the number of relay modules that may be powered; this problem is resolved using the supply distribution module as illustrated in point three.

### Easy Bridge System

The **PTC/CK/42** quick connector jumper comprises a 42 pole comb with capacity for a maximum current of 32 A, limited to the capacity of the 24 A terminal block, therefore in a plug-in jumper of e.g. 11 poles (1 common and 10 distribution) 2.4 A can be distributed per pole.

The jumper is designed to be extremely simple and economical, with an innovative terminal block that isolates the jumper and a connection system that is not only fast, but requires no specific tools to use.

- the jumper should be divided as required simply using nail clippers, close to the pole to maintain a protection degree IP20 (1 and 2),
- insert the jumper into the relevant terminal block hole (3),
- use a screwdriver to push the jumper in until it locks. The jumper will now be completely isolated (4),
- to remove the jumper simply insert a screwdriver into the jumper slot, lift it and slide it out (5 and 6).

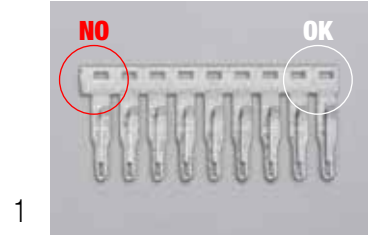

1

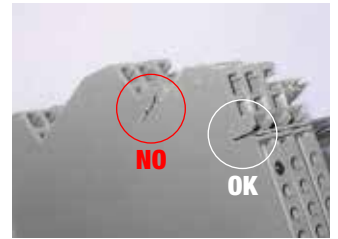

2



3



4

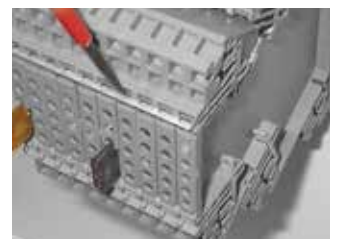

5



6



# Single relay modules

## CKR series

- Replaceable contact safety fuse
- Positive or negative common AC/DC input
- Frontal status LED, reverse polarity protection, coil damping diode
- Width 6 mm
- Available plug-in jumper for potential distribution

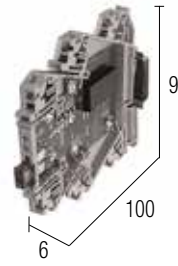
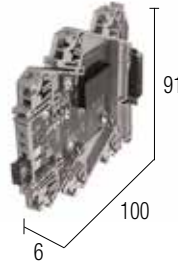

### NOTES

- (1) The XCKR16 module is equipped with a 7.5 A automobile-type quick replaceable contact safety fuse, connected in series to contact 11 (common pole); this can be replaced with a fuse of a lesser value to provide compatibility with the load and/or wiring current; a fuse greater than 7.5 A does not protect the contact. The fuse used is suitable for SELV  $\leq 50$  Vac and  $\leq 75$  Vdc voltages; if used with greater voltages it will not guarantee cut-off capability and safe operation.
- (2) Product made to order (not kept in stock).
- (3) the final module must always be protected with the CK/PT terminal wall to ensure protection degree IP20.

### BLOCK DIAGRAM

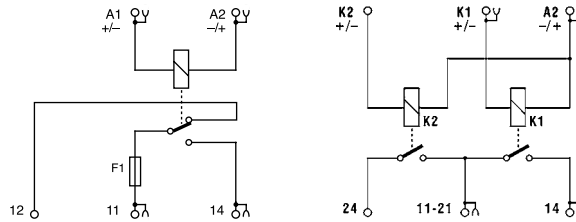

### VERSIONS

- 1 channel
- 2 channels

#### Cat. No. XCKR16

CKR16

#### Cat. No. XCKR25

CKR25 (2)

### INPUT TECHNICAL DATA

- Nominal voltage
- Power consumption (1 channel)
- Turn ON time
- Turn OFF time
- Protection circuit

24 Vac/dc  $\pm 10\%$

$\leq 15$  mA  $\pm 10\%$  at 24 Vdc

5 ms

10 ms

damping diode

24 Vac/dc  $\pm 10\%$

$\leq 13$  mA  $\pm 10\%$  at 24 Vdc

5 ms

10 ms

damping diode

### OUTPUT TECHNICAL DATA

- Contact type
- Nominal current (resistive load)
- Max. cut-off capacity
- Max. fuse current

1 exchange AgSnO<sub>2</sub>

6 A / 250 Vac

30 A

—

2 NA AgSnO<sub>2</sub>

5 A / 250 Vac

30 A

—

### GENERAL TECHNICAL DATA

- Operating temperature range
- Coil isolation / contacts
- Isolation between output terminal blocks
- Protection degree
- Overvoltage category / Pollution degree
- Reference Standards
- Power/status indicator
- Connection type

-20...+60°C

3 kVac / 60 s

—

IP 20 IEC529, EN60529

II / 2

IEC 664-1, DIN VDE 0110.1

Green LED

Fixed AWG26-14 2.5 mm<sup>2</sup> spring terminal blocks

UL94V-0 polyamide

40 g

vertical on rails, side by side

-20...+60°C

3 kVac / 60 s

—

IP 00 IEC529, EN60529

II / 2

IEC 664-1, DIN VDE 0110.1

Green LED

Fixed AWG26-14 2.5 mm<sup>2</sup> spring terminal blocks

UL94V-0 polyamide

43 g

vertical on rails, side by side

### MOUNTING ACCESSORIES

- Mounting rail compliant with IEC60715/TH35
- Mounting rail type according to IEC60715/G32
- Spare part relay (1)
- Jumper —
- Marking tag neutral
- End section

PR/3/AC, PR/3/AC/ZB, PR/3/AS, PR/3/AS/ZB

PR/3/AC, PR/3/AC/ZB, PR/3/AS, PR/3/AS/ZB

—

—

—

—

Cat. No. PTCK42 (42 poles)

Cat. No. PTCK42 (42 poles)

Cat. No. NU0851

Cat. No. NU0851

Cat. No. XCKPT

Cat. No. XCKPT

# Single relay modules CKR series

- Pluggable relay
- Frontal status LED
- Width 6.2 mm
- Available plug-in jumper for potential distribution

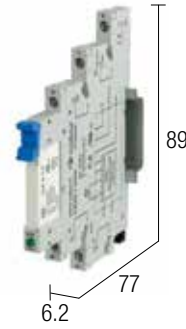

## NOTES

Measurements include rail clamp clearance.

- (1) Made to order (not kept in stock), for information contact our sales office.
- (2) Relay make and model are not final and may be replaced without notice. The technical details shown are to be considered typical.

## APPLICATIONS

The CWRE series is designed for signal switching and is equipped with a pluggable relay to facilitate maintenance procedures. They can also be used in parallel from both the input and output sides using a specific plug-in jumper.

## BLOCK DIAGRAM

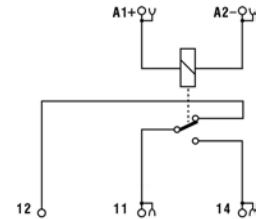

## VERSIONS

12 Vac/dc	(1)
24 Vac/dc	
48 Vac/dc	(1)
115 Vac/dc	
230 Vac/dc	

## INPUT TECHNICAL DATA

Nominal voltage	
Power consumption (1 channel)	
Turn ON time	
Turn OFF time	
Protection circuit	

## OUTPUT TECHNICAL DATA

Contact type	
Nominal current (resistive load)	
Max. cut-off capacity	
Max. fuse current	

## GENERAL TECHNICAL DATA

Operating temperature range	-40...+70°C				
Coil isolation / contacts	4 kVac / 60 s				
Isolation between output terminal blocks	1 kVac / 60 s (between open contact poles)				
Protection degree	IP 20 IEC 529, EN60529				
Overvoltage category / Pollution degree	III / 2				
Reference Standards	IEC 664.1, DIN VDE 0110.1				
Power/status indicator	Green LED				
Connection type	AWG26-14 2.5 mm <sup>2</sup> screw clamp terminal blocks				
Housing material	UL94V-0 plastic				
Approximate weight	35 g				
Mounting information	on rails, side by side				

## MOUNTING ACCESSORIES

Mounting rail type according to IEC60715/TH35-7.5	
Mounting rail type according to IEC60715/G32	
Spare part relay	(2)
Cross connection bridge	black white blue
Marking tag	neutral
End section	

Cat. No. X766848	Cat. No. X766842	Cat. No. X766845	Cat. No. X766846	Cat. No. X766847
<b>CWRE7-0848 (1)</b>				
	<b>CWRE7-0842</b>			
		<b>CWRE7-0845 (1)</b>		
			<b>CWRE7-0846</b>	
				<b>CWRE7-0847</b>
<b>12 Vac/dc ±10%</b>	<b>24 Vac/dc ±10%</b>	<b>48 Vac/dc ±10%</b>	<b>115 Vac/dc ±10%</b>	<b>230 Vac/dc ±10%</b>
10 mA ±10%	7 mA ±10%	5 mA ±10%	4 mA ±10%	4 mA ±10%
8 ms	8 ms	7 ms	8 ms	8 ms
5 ms	5 ms	7 ms	13 ms	13 ms
damping diode, reverse polarity protection diode jumper				
1 exchange AgSnO <sub>2</sub> (3)				
<b>6 A / 250 Vac ; 6 A / 30 Vdc</b>				
DC 13: 24 V / 1A; 115V / 200 mA; 230 V / 100 mA				
—				
PR/3/AC, PR/3/AC/ZB, PR/3/AS, PR/3/AS/ZB				
—				
	Cat. No. 8904027			
—				
CWBK7-0813 (Cat. No. X766813) (20 poles)				
Cat. No. NUPUTUK50				
—				

# Multiple relay quick selection table

These tables are used for quickly identifying items and verifying whether all of the product's technical details satisfy the set requirements.

Number of relays	Nominal voltage input	Output type/no. of contacts	nominal current	Notes	Type	Cat. No.	Page
4	24 Vdc	SPDT	12 A	(1) (4)	R41E24	XR041E24	97
8	24 Vdc	SPDT	12 A	(1) (4)	R81E24	XR081E24	97
16	24 Vdc	SPDT	12 A	(1) (4)	R161E24	XR161E24	97
4	24 Vac/dc	SPDT	12 A	(1) (6)	R41EAD	XR041EAD	98
8	24 Vac/dc	SPDT	12 A	(1) (6)	R81EAD	XR081EAD	98
16	24 Vac/dc	SPDT	12 A	(1) (6)	R161EAD	XR161EAD	98
4	24 Vac/dc	SPDT	12 A	(1) (6) (8)	R41U24F	XR041U24F	99
8	24 Vac/dc	SPDT	12 A	(1) (6) (8)	R81U24F	XR081U24F	99
16	24 Vac/dc	SPDT	12 A	(1) (6) (8)	R161U24F	XR161U24F	99
4	24 Vdc	DPDT	8 A	(1) (4)	R42E24	XR042E24	100
8	24 Vdc	DPDT	8 A	(1) (4)	R82E24	XR082E24	100
16	24 Vdc	DPDT	8 A	(1) (4)	R162E24	XR162E24	100
4	24 Vac/dc	DPDT	8 A	(1) (6)	R42EAD	XR042EAD	101
8	24 Vac/dc	DPDT	8 A	(1) (6)	R82EAD	XR082EAD	101
16	24 Vac/dc	DPDT	8 A	(1) (6)	R162EAD	XR162EAD	101
8	24 Vac/dc	SPDT	12 A	(1) (6) (9) (10)	RMP081CM	XRMP081CM	102
4	110 Vdc/120 Vac	SPDT	10 A	(1) (6)	R41E11A	XR041E1A	103
4	24 Vac/dc	SPDT	8 A	(2) (6)	CR4-1	XCR41	103
4	24 Vac/dc	SPDT	8 A	(1) (6)	CRE4-1	XCRE41	103
8	24 Vac/dc	SPST(NO)	8 A	(1) (6)	CRE8-1	XCRE81	103
8	24 Vac/dc	SPST(NO)	8 A	(2) (6)	CR8-1	XCR81	103
4	24 Vac/dc	DPDT	8 A	(2) (6)	CR4-2SC	XCR42SC	104
4	24 Vac/dc	DPDT	8 A	(1) (6)	CRE4-2SC	XCRE42SC	123

## Notes

- |                                       |  |
|---------------------------------------|--|
| (1) pluggable relay version           | (6) universal common, negative DC control, positive DC, AC |
| (2) fixed relay version               | (7) control via connector                                  |
| (3) base without relay                | (8) safety fuse on contact                                 |
| (4) negative common, positive control | (9) with test button                                       |
| (5) positive common, negative control | (10) with test switch                                      |

# Multi-relay modules

- Control with direct current voltages
- Operation with negative common
- LED status indicator
- Pluggable relay

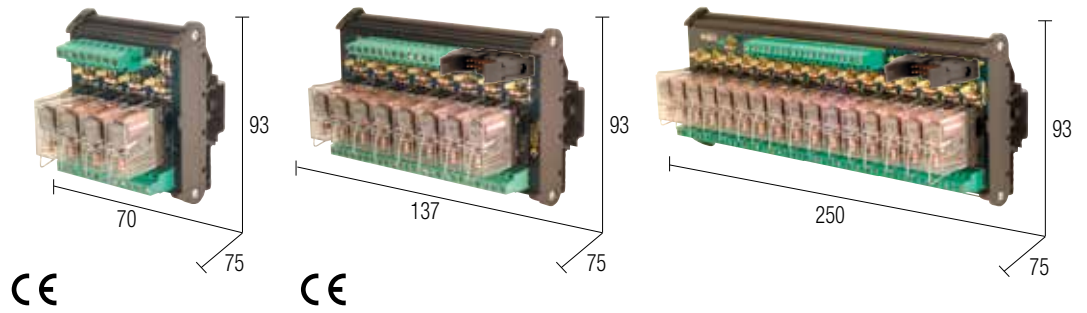

## NOTES

Measurements include rail clamp clearance.  
 (1) Relay make and model are not final and may be replaced without notice. The technical details shown are to be considered typical

## BLOCK DIAGRAM

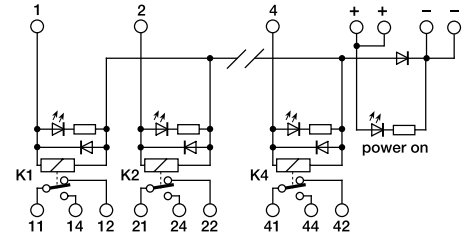

4 relay module

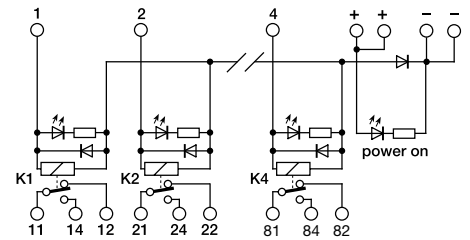

8 relay module

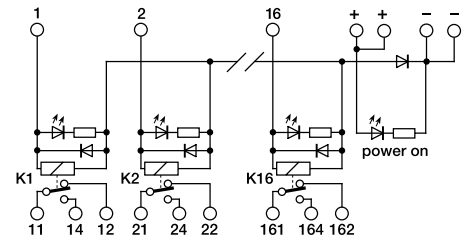

16 relay module

## VERSIONS

4 relay module

8 relay module

16 relay module

Cat. No. XR041E24	Cat. No. XR081E24	Cat. No. XR161E24
R41E24	R81E24	R161E24

## INPUT TECHNICAL DATA

Nominal voltage	24 Vdc ± 10%
Power consumption (1 channel)	22 mA ± 10%
Turn ON time	15 ms
Turn OFF time	5 ms
Protection circuit	damping diode, reverse polarity protection diode

## OUTPUT TECHNICAL DATA

Contact type	1 exchange AgSnO <sub>2</sub>
Nominal load (resistive)	12 A / 250 Vac
Max. cut-off capacity	12 A
Max. fuse current	—

## GENERAL TECHNICAL DATA

Operating temperature range	-10...+50°C
Coil isolation / contacts	2.5 kVac / 60 s
Isolation between output terminal blocks	1 kVac / 60 s (between open contact poles)
Protection degree	IP 20 IEC 529, EN60529
Surge category/degree of pollution	III / 2
Reference Standards	IEC 664-1, DIN VDE 0110.1
Power/status indicator	Green LED / Yellow LED
Connection type	2.5 mm <sup>2</sup> fixed screw terminal blocks and FLAT connector
Housing material	UL94V-0 plastic
Approximate weight	188 g   342 g   657 g
Mounting information	on rails, side by side

## MOUNTING ACCESSORIES

Mounting rail compliant with IEC60715/TH35	PR/3/AC, PR/3/AC/ZB, PR/3/AS, PR/3/AS/ZB
Mounting rail type according to IEC60715/G32	PR/DIN/AC - PR/DIN/AS - PR/DIN/AL
Spare part relay (1)	Cat. No. 8904001
Jumper	red white blue

# Multi-relay modules

- Control with both alternating and direct current voltages
- Operation with both positive and negative common
- LED status indicator
- Pluggable relay

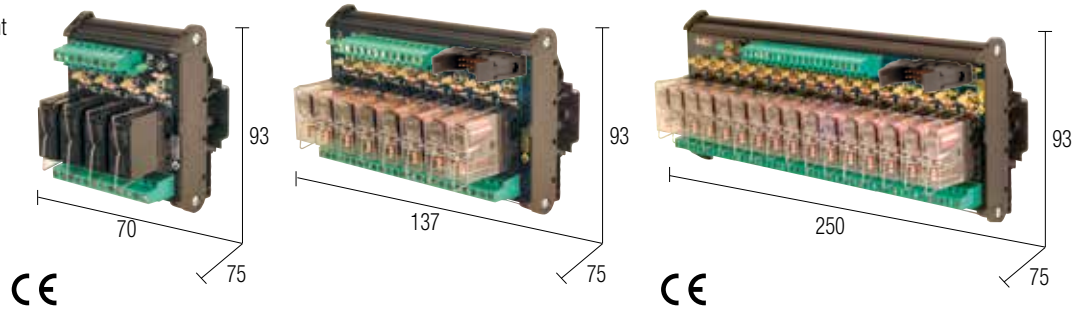

## NOTES

Measurements include rail clamp clearance.  
 (1) Relay make and model are not final and may be replaced without notice. The technical details shown are to be considered typical.  
 (2) Product made to order (not kept in stock).

### POWER SUPPLY COMPATIBILITY

A1 = +	A2 = -	negative common
A1 = -	A2 = +	positive common
A1 = ~	A2 = ~	AC power supply

## BLOCK DIAGRAM

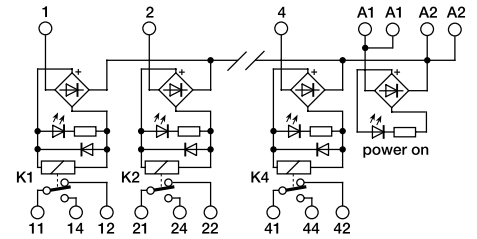

4 relay module

## VERSIONS

4 relay module

8 relay module

16 relay module

Cat. No. XR041EAD	Cat. No. XR081EAD	Cat. No. XR161EAD
R41EAD	R81EAD	R161EAD

## INPUT TECHNICAL DATA

Nominal voltage	24 Vac/dc ± 10%
Power consumption (1 channel)	22 mA ± 10%
Turn ON time	15 ms
Turn OFF time	5 ms
Protection circuit	damping diode, reverse polarity protection diode jumper

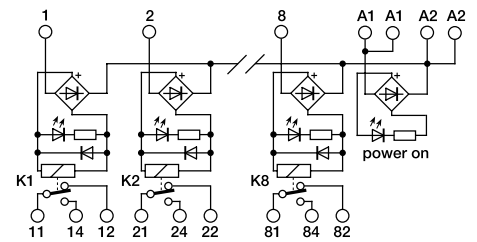

8 relay module

## OUTPUT TECHNICAL DATA

Contact type	1 exchange AgSnO <sub>2</sub>
Nominal load (resistive)	12 A / 250 Vac
Max. cut-off capacity	12 A
Max. fuse current	—

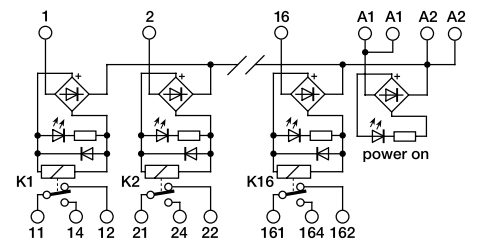

16 relay module

## GENERAL TECHNICAL DATA

Operating temperature range	-10...+50°C
Coil isolation / contacts	2.5 kVac / 60 s
Isolation between output terminal blocks	1 kVac / 60 s (between open contact poles)
Protection degree	IP 00 IEC 529, EN60529
Surge category/degree of pollution	III / 2
Reference Standards	IEC 664-1, DIN VDE 0110.1
Power/status indicator	Green LED / Yellow LED
Connection type	2.5 mm <sup>2</sup> fixed screw terminal blocks and FLAT connector
Housing material	UL94V-0 plastic
Approximate weight	192 g   345 g   688 g
Mounting information	on rails, side by side

## MOUNTING ACCESSORIES

Mounting rail compliant with IEC60715/TH35	PR/3/AC, PR/3/AC/ZB, PR/3/AS, PR/3/AS/ZB
Mounting rail type according to IEC60715/G32	PR/DIN/AC - PR/DIN/AS - PR/DIN/AL
Spare part relay (1)	Cat. No. 8904001
Jumper	red white blue

# Multi-relay modules with fuse

- Control with both alternating and direct current voltages
- Operation with both positive and negative common
- LED status indicator
- Pluggable relay
- Output contact safety fuse

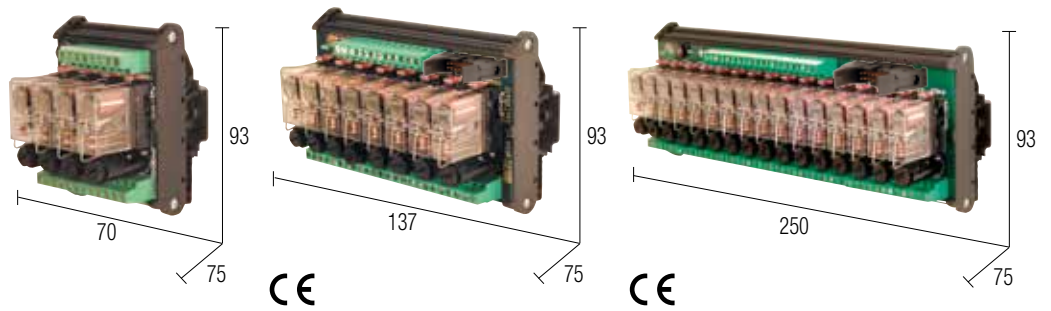

## NOTES

Measurements include rail clamp clearance. (1) Relay make and model are not final and may be replaced without notice. The technical details shown are to be considered typical. (2) The interface is provided without a fuse and the fuse holder cap is in a bag inside the package. The fuse must be of a suitable size for the load. The max. value of 6.3 A refers to fuses compliant with EN60127 and at the nominal approved current of the fuse holder. Larger fuses can cause damage to the fuse holder and to the module.

### POWER SUPPLY COMPATIBILITY

A1 = +	A2 = -	negative common
A1 = -	A2 = +	positive common
A1 = ~	A2 = ~	AC power supply

## BLOCK DIAGRAM

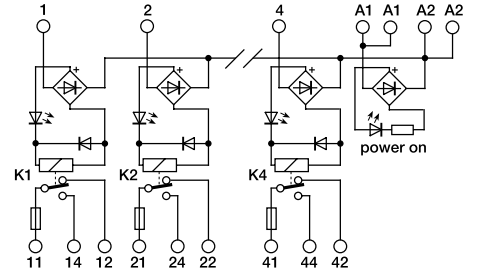

4 relay module

## VERSIONS

4 relay module

8 relay module

16 relay module

Cat. No. XR041U24F	Cat. No. XR081U24F	Cat. No. XR161U24F
R41U24F	R81U24F	R161U24F

## INPUT TECHNICAL DATA

Nominal voltage	24 Vac/dc ± 10%
Power consumption (1 channel)	22 mA ± 10%
Turn ON time	15 ms
Turn OFF time	10 ms
Protection circuit	damping diode, reverse polarity protection diode jumper

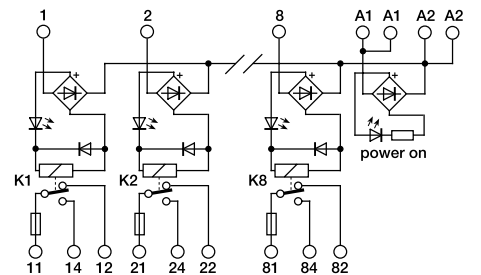

8 relay module

## OUTPUT TECHNICAL DATA

Contact type	1 exchange AgSnO <sub>2</sub>
Nominal load (resistive)	12 A / 250 Vac
Max. cut-off capacity	12 A
Max. fuse current	6.3 A (2)

## GENERAL TECHNICAL DATA

Operating temperature range	-10...+50°C
Coil isolation / contacts	2.5 kVac / 60 s
Isolation between output terminal blocks	1 kVac / 60 s (between open contact poles)
Protection degree	IP 00 IEC 529, EN60529
Surge category/degree of pollution	III / 2
Reference Standards	IEC 664-1, DIN VDE 0110.1
Power/status indicator	Green LED / Yellow LED
Connection type	2.5 mm <sup>2</sup> fixed screw terminal blocks and FLAT connector
Housing material	UL94V-0 plastic
Approximate weight	210 g   326 g   770 g
Mounting information	on rails, side by side

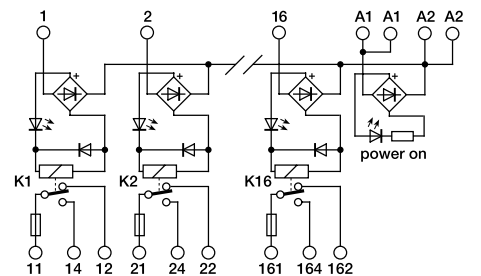

16 relay module

## MOUNTING ACCESSORIES

Mounting rail compliant with IEC60715/TH35	PR/3/AC, PR/3/AC/ZB, PR/3/AS, PR/3/AS/ZB
Mounting rail type according to IEC60715/G32	PR/DIN/AC - PR/DIN/AS - PR/DIN/AL
Spare part relay (1)	Cat. No. 8904001
Jumper	red white blue



# Multi-relay modules

- Control with direct current voltages
- Operation with negative common
- LED status indicator
- Pluggable relay

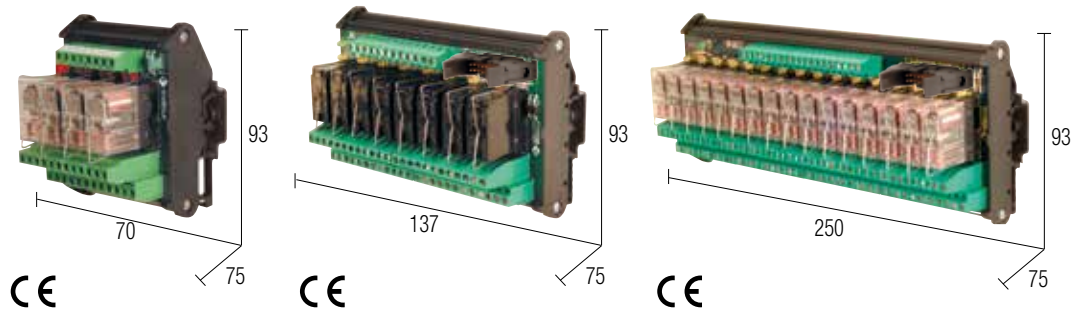

## NOTES

Measurements include rail clamp clearance.  
 (1) Relay make and model are not final and may be replaced without notice. The technical details shown are to be considered typical.

## BLOCK DIAGRAM

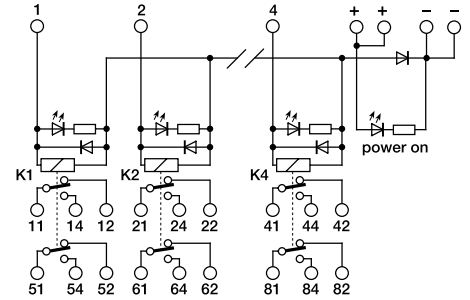

4 relay module

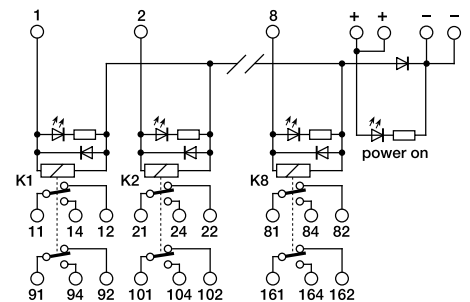

8 relay module

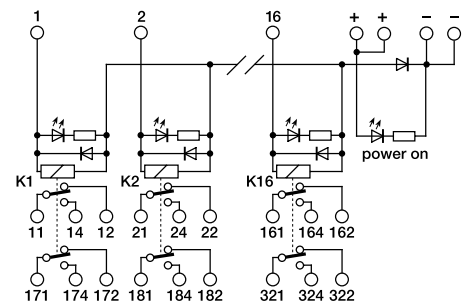

16 relay module

## VERSIONS

4 relay module

8 relay module

16 relay module

Cat. No. XR042E24	Cat. No. XR082E24	Cat. No. XR162E24
R42E24	R82E24	R162E24

## INPUT TECHNICAL DATA

Nominal voltage	24 Vdc ± 10%
Power consumption (1 channel)	22 mA ± 10%
Turn ON time	15 ms
Turn OFF time	10 ms
Protection circuit	damping diode, reverse polarity protection diode

## OUTPUT TECHNICAL DATA

Contact type	2 exchanges AgNi
Nominal load (resistive)	8 A / 250 Vac
Max. cut-off capacity	8 A
Max. fuse current	—

## GENERAL TECHNICAL DATA

Operating temperature range	-10...+50°C
Coil isolation / contacts	2.5 kVac / 60 s
Isolation between output terminal blocks	1 kVac / 60 s (between open contact poles)
Protection degree	IP 00 IEC 529, EN60529
Surge category/degree of pollution	III / 2
Reference Standards	IEC 664-1, DIN VDE 0110.1
Power/status indicator	Green LED / Yellow LED
Connection type	2.5 mm <sup>2</sup> fixed screw terminal blocks and FLAT connector
Housing material	UL94V-0 plastic
Approximate weight	225 g   419 g   811 g
Mounting information	on rails, side by side

## MOUNTING ACCESSORIES

Mounting rail compliant with IEC60715/TH35	PR/3/AC, PR/3/AC/ZB, PR/3/AS, PR/3/AS/ZB
Mounting rail type according to IEC60715/G32	PR/DIN/AC - PR/DIN/AS - PR/DIN/AL
Spare part relay (1)	Cat. No. 8904002
Jumper	red white blue

# Multi-relay modules

- Control with both alternating and direct current voltages
- Operation with both positive and negative common
- LED status indicator
- Pluggable relay

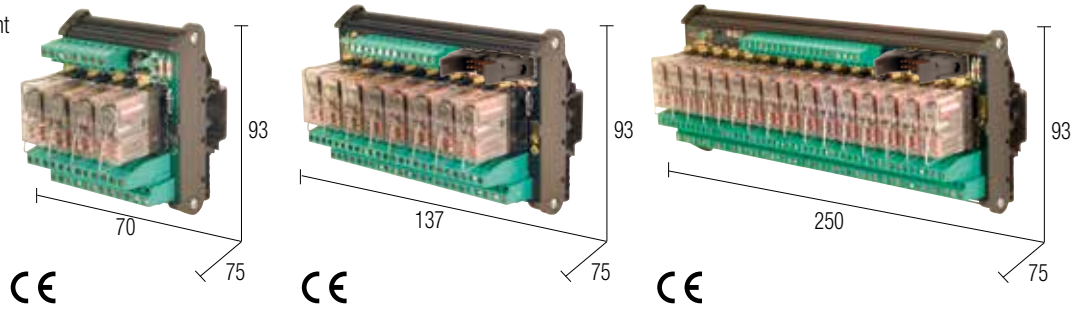

## NOTES

Measurements include rail clamp clearance.  
 (1) Relay make and model are not final and may be replaced without notice. The technical details shown are to be considered typical.  
 (2) Product made to order (not kept in stock).

### POWER SUPPLY COMPATIBILITY

A1 = +	A2 = -	negative common
A1 = -	A2 = +	positive common
A1 = ~	A2 = ~	AC power supply

## BLOCK DIAGRAM

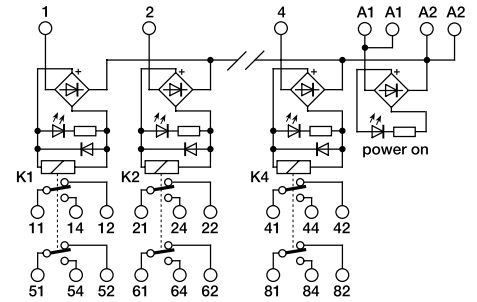

4 relay module

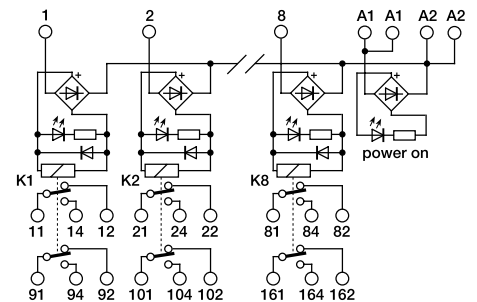

8 relay module

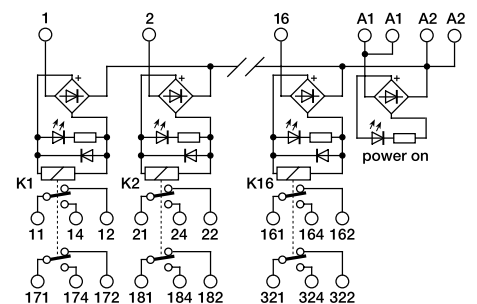

16 relay module

## VERSIONS

4 relay module

8 relay module

16 relay module

Cat. No. XR042EAD	Cat. No. XR082EAD	Cat. No. XR162EAD
R42EAD	R82EAD	R162EAD

## INPUT TECHNICAL DATA

Nominal voltage	24 Vac/dc $\pm$ 10%
Power consumption (1 channel)	22 mA $\pm$ 10%
Turn ON time	15 ms
Turn OFF time	5 ms
Protection circuit	damping diode, reverse polarity protection diode jumper

## OUTPUT TECHNICAL DATA

Contact type	2 exchanges AgNi
Nominal load (resistive)	8 A / 250 Vac
Max. cut-off capacity	8 A
Max. fuse current	—

## GENERAL TECHNICAL DATA

Operating temperature range	-10...+50°C
Coil isolation / contacts	2.5 kVac / 60 s
Isolation between output terminal blocks	1 kVac / 60 s (between open contact poles)
Protection degree	IP 00 IEC 529, EN60529
Surge category/degree of pollution	III / 2
Reference Standards	IEC 664-1, DIN VDE 0110.1
Power/status indicator	Green LED / Yellow LED
Connection type	2.5 mm <sup>2</sup> fixed screw terminal blocks and FLAT connector
Housing material	UL94V-0 plastic
Approximate weight	227 g   427 g   835 g
Mounting information	on rails, side by side

## MOUNTING ACCESSORIES

Mounting rail compliant with IEC60715/TH35	PR/3/AC, PR/3/AC/ZB, PR/3/AS, PR/3/AS/ZB
Mounting rail type according to IEC60715/G32	PR/DIN/AC - PR/DIN/AS - PR/DIN/AL
Spare part relay (1)	Cat. No. 8904002
Jumper	red white blue

# Multi-relay modules with test button

- Control with both alternating and direct current voltages
- Operation with both positive and negative common
- LED status indicator
- Pluggable relay
- Test with buttons and switches

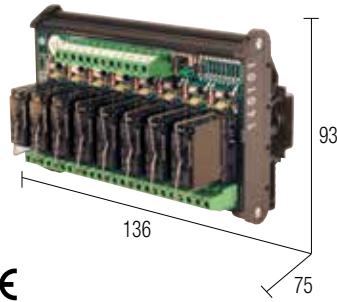

## NOTES

Measurements include rail clamp clearance.  
 (1) Relay make and model are not final and may be replaced without notice. The technical details shown are to be considered typical.  
 (2) Replaces cards XRP08124 and XRD08124.

### POWER SUPPLY COMPATIBILITY

A1 = +	A2 = -	negative common
A1 = -	A2 = +	positive common
A1 = ~	A2 = ~	AC power supply

## BLOCK DIAGRAM

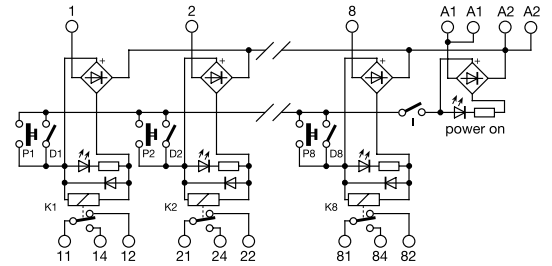

- P = test button
- D = DIP-switch
- IG = general switch for isolating buttons and the DIP-switch

## VERSIONS

With push-button and DIP-switch

Cat. No. XRMP081CM (2)

RMPO81CM

## INPUT TECHNICAL DATA

Nominal voltage	24 Vac/dc ± 10%
Power consumption (1 channel)	22 mA ± 10%
Turn ON time	15 ms
Turn OFF time	5 ms
Protection circuit	damping diode, reverse polarity protection diode jumper

## OUTPUT TECHNICAL DATA

Contact type	1 exchange AgSnO <sub>2</sub> for 8 relays
Nominal load (resistive)	12 A / 250 Vac
Max. cut-off capacity	12 A
Max. fuse current	—

## GENERAL TECHNICAL DATA

Operating temperature range	-10...+50°C
Coil isolation / contacts	2.5 kVac / 60 s
Isolation between output terminal blocks	1 kVac / 60 s (between open contact poles)
Protection degree	IP 00 IEC 529, EN60529
Surge category/degree of pollution	III / 2
Reference Standards	IEC 664-1, DIN VDE 0110.1
Power/status indicator	Green LED / Yellow LED
Connection type	2.5 mm <sup>2</sup> fixed screw terminal blocks
Housing material	UL94V-0 plastic
Approximate weight	350 g
Mounting information	on rails, side by side

This product can be operated in either alternating or direct current. Relay activation can be forced temporarily using the relevant button, or permanently using a DIP-switch.

## MOUNTING ACCESSORIES

Mounting rail compliant with IEC60715/TH35	PR/3/AC, PR/3/AC/ZB, PR/3/AS, PR/3/AS/ZB
Mounting rail type according to IEC60715/G32	PR/DIN/AC - PR/DIN/AS - PR/DIN/AL
Spare part relay (1)	Cat. No. 8904001
Jumper	red white blue

IG P D (not shown)

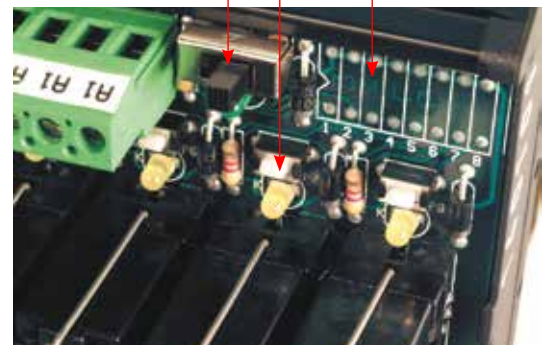

# Super compact relay modules CR & CRE series

- 3 kV Input/Output isolation
- 1 kV isolation between output contacts
- Fast cabling extractable terminal blocks
- Control with both alternating and direct current voltages
- Operation with both positive and negative common

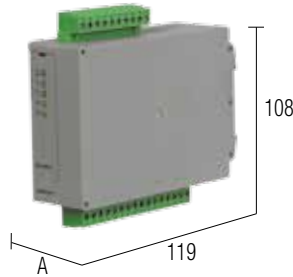

A = 22.5 mm CR version, 35 mm CRE version

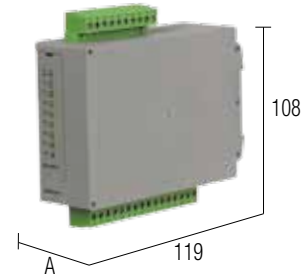

A = 22.5 mm CR version, 35 mm CRE version

## NOTES

Measurements include rail clamp clearance.

(1) Relay make and model are not final and may be replaced without notice. The technical details shown are to be considered typical.

**CR4-1** and **CRE4-1**: 4-relay module with exchange contact, inputs and outputs with removable terminal blocks.

**CR8-1** and **CRE8-1**: 8-relay module with NA contact, inputs and outputs with removable terminal blocks.

## BLOCK DIAGRAM

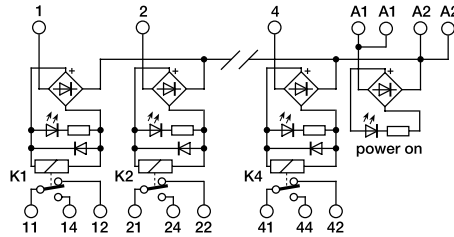

## BLOCK DIAGRAM

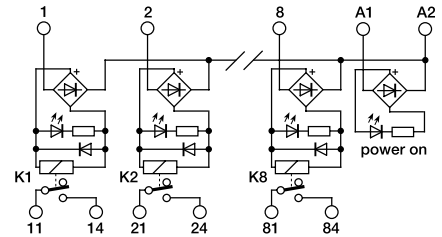

## VERSIONS

Pluggable relay  
Fixed relay

Cat. No. XCRE41

Cat. No. XCR4

Cat. No. XCRE81

Cat. No. XCR81

CRE4-1

CR4-1

CRE8-1

CR8-1

## INPUT TECHNICAL DATA

Nominal voltage	24 Vac/dc ± 10%
Power consumption (1 channel)	16 mA ± 10%
Turn ON time	7 ms
Turn OFF time	3 ms
Protection circuit	damping diode, reverse polarity protection diode jumper

Nominal voltage	24 Vac/dc ± 10%
Power consumption (1 channel)	16 mA ± 10%
Turn ON time	7 ms
Turn OFF time	3 ms
Protection circuit	damping diode, reverse polarity protection diode jumper

## OUTPUT TECHNICAL DATA

Contact type	1 AgNiO exchange for 4 relays
Nominal load (resistive)	8 A / 250 Vac
Max. cut-off capacity	2000 VA
Max. fuse current	—

Contact type	1 NA contact for 8 relays
Nominal load (resistive)	8 A / 250 Vac
Max. cut-off capacity	2000 VA
Max. fuse current	—

## GENERAL TECHNICAL DATA

Operating temperature range	-10...+50°C
Coil isolation / contacts	2.5 kVac / 60 s
Isolation between output terminal blocks	1 kVac / 60 s (between open contact poles)
Protection degree	IP 20 IEC 529, EN60529
Surge category/degree of pollution	III / 2
Reference Standards	IEC 664-1, DIN VDE 0110.1
Power/status indicator	Green LED / Yellow LED
Connection type	2.5 mm <sup>2</sup> fixed screw terminal blocks
Housing material	UL94V-0 plastic
Approximate weight	143 g (180 g removable version)
Mounting information	on rails, side by side

Operating temperature range	-10...+50°C
Coil isolation / contacts	3 kVac / 60 s
Isolation between output terminal blocks	1 kVac / 60 s (between open contact poles)
Protection degree	IP 20 IEC 529, EN60529
Surge category/degree of pollution	III / 2
Reference Standards	IEC 664-1, DIN VDE 0110.1
Power/status indicator	Green LED / Yellow LED
Connection type	2.5 mm <sup>2</sup> removable screw terminal blocks
Housing material	UL94V-0 plastic
Approximate weight	199 g (250 g removable version)
Mounting information	on rails, side by side

## MOUNTING ACCESSORIES

Mounting rail compliant with IEC60715/TH35	PR/3/AC, PR/3/AC/ZB, PR/3/AS, PR/3/AS/ZB
Mounting rail type according to IEC60715/G32	PR/DIN/AC - PR/DIN/AS - PR/DIN/AL
Spare part relay (1)	Cat. No. 8904042
Jumper	red white blue

Mounting rail compliant with IEC60715/TH35	PR/3/AC, PR/3/AC/ZB, PR/3/AS, PR/3/AS/ZB
Mounting rail type according to IEC60715/G32	PR/DIN/AC - PR/DIN/AS - PR/DIN/AL
Spare part relay (1)	Cat. No. 8904042
Jumper	red white blue

# Super compact relay modules CR & CRE series

- 3 kV Input/Output isolation
- 1 kV isolation between output contacts
- Fast cabling extractable terminal blocks
- Control with both alternating and direct current voltages
- Operation with both positive and negative common

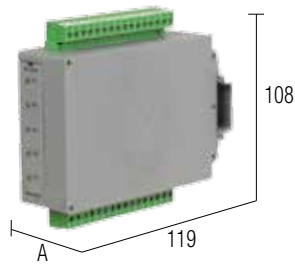

A = 22.5 mm CR version, 35 mm CRE version

## NOTES

- Measurements include rail clamp clearance.
- (1) Relay make and model are not final and may be replaced without notice. The technical details shown are to be considered typical.
- (2) Version made to order (not kept in stock); contact our sales office for availability.

## BLOCK DIAGRAM

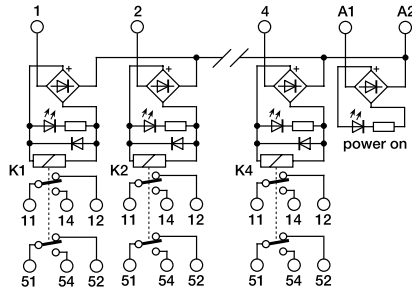

## VERSIONS

- Pluggable relay
- Fixed relay

Cat. No. XCRE42SC	Cat. No. XCR42SC
CRE4-2SC (2)	CR4-2SC (2)

## INPUT TECHNICAL DATA

Nominal voltage	24 Vac/dc $\pm$ 10%
Power consumption (1 channel)	25 mA $\pm$ 10%
Turn ON time	7 ms
Turn OFF time	2 ms
Protection circuit	damping diode, reverse polarity protection diode jumper

## OUTPUT TECHNICAL DATA

Contact type	2 AgNi exchanges for 4 relays
Nominal load (resistive)	8 A / 250 Vac
Max. cut-off capacity	2000 VA
Max. fuse current	—

## GENERAL TECHNICAL DATA

Operating temperature range	-10...+50°C
Coil isolation / contacts	2.5 kVac / 60 s
Isolation between output terminal blocks	1 kVac / 60 s (between open contact poles)
Protection degree	IP 20 IEC 529, EN60529
Surge category/degree of pollution	III / 2
Reference Standards	IEC 664-1, DIN VDE 0110.1
Power/status indicator	Green LED / Yellow LED
Connection type	2.5 mm <sup>2</sup> removable screw terminal blocks
Housing material	UL94V-0 plastic
Approximate weight	137 g (180 g removable version)
Mounting information	on rails, side by side

## MOUNTING ACCESSORIES

Mounting rail compliant with IEC60715/TH35	PR/3/AC, PR/3/AC/ZB, PR/3/AS, PR/3/AS/ZB
Mounting rail type according to IEC60715/G32	PR/DIN/AC - PR/DIN/AS - PR/DIN/AL
Spare part relay (1)	Cat. No. 8904052
Jumper	red white blue

# Siemens S7 PLC (300 and 400) interface modules

- Super compact size with CR version
- Fast cabling
- Pluggable relay

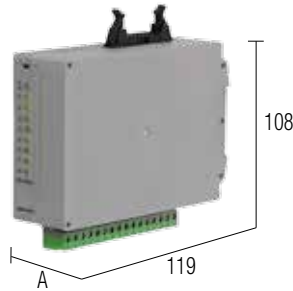

A = 22.5 mm CR version, 35 mm CRE version

## NOTES

- (1) Relay make and model are not final and may be replaced without notice. The technical details shown are to be considered typical.  
(2) Product made to order (not kept in stock).

## BLOCK DIAGRAM

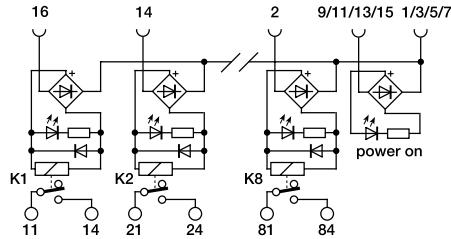

## VERSIONS

- Pluggable relay
- Fixed relay

Cat. No. XCRE83

CRE8-3

Cat. No. XCR83

CR8-3

## INPUT TECHNICAL DATA

Nominal voltage	24 Vac/dc $\pm$ 10%
Power consumption (1 channel)	16 mA $\pm$ 10%
Turn ON time	15 ms
Turn OFF time	5 ms
Protection circuit	damping diode, reverse polarity protection diode jumper

## OUTPUT TECHNICAL DATA

Contact type	1 NA contact for 8 relays
Nominal load (resistive)	10 A / 250 Vac
Max. cut-off capacity	2000 VA
Max. fuse current	—

## GENERAL TECHNICAL DATA

Operating temperature range	-10...+50°C
Coil isolation / contacts	3 kVac / 60 s
Isolation between output terminal blocks	1 kVac / 60 s (between open contact poles)
Protection degree	IP 20 IEC 529, EN60529
Surge category/degree of pollution	III / 2
Reference Standards	IEC 664-1, DIN VDE 0110.1
Power/status indicator	Green LED / Yellow LED
Connection type	male 16 pole flat
Housing material	UL94V-0 plastic
Approximate weight	199 g
Mounting information	on rails, side by side

## MOUNTING ACCESSORIES

Mounting rail compliant with IEC60715/TH35	PR/3/AC, PR/3/AC/ZB, PR/3/AS, PR/3/AS/ZB
Mounting rail type according to IEC60715/G32	—
Spare part relay (1)	Cat. No. 8904042
Jumper	—
red	—
white	—
blue	—



# Opto-isolated relay quick selection table

These tables are used for quickly identifying items and verifying whether all of the product's technical details satisfy the set requirements.

## Input modules

Number of channels	Input voltage	Applicable load		Notes	Type	Cat. No.	Page
		Voltage	Current				
1	5...24 Vdc	5...48 Vdc	3 A	(2)	O332060	XO332060	107
1	5...24 Vdc	5...48 Vdc	500 mA	(2)	CW0T 6-2082	X766082	113
1	12...24 Vdc	5...48 Vdc	500 mA	(2)	CW0T 6-2083	X766083	112
1	12...24 Vdc	5...48 Vdc	5 A	(1)	CM1S024E	XCM1S024E	108
1	24 Vdc	5...48 Vdc	2 A	(1)	CM1S024	XCM1S024	108
1	5...12 Vdc	5...24 Vdc	5 A	(2) (4)	CKS15NA	XCKS15NA	110
1	5...24 Vdc	5...24 Vdc	30 mA	(2)	CKS1S	XCKS1S	113
1	24 Vdc	5...24 Vdc	5 A	(2) (4)	CKS15NB	XCKS15NB	110
1	5...24 Vdc	5...24 Vdc	5 A	(2) (5)	CKS15E	XCKS15E	111
1	12...24 Vdc	12...240 Vac	3 A	(1)	CM1T024E	XCM1T024E	109
1	5...24 Vdc	24...240 Vac	4 A	(2)	O332240	XO332240	107
1	24 Vdc	48...240 Vac	2 A	(1)	CM1T024	XCM1T024	109
2	12...24 Vdc	12...24 Vdc	2 x 2.5 A	(2)	CKS22	XCKS22	109
4	24 Vdc	5...48 Vdc	2 A	(1) (3) (4)	R41S24F	XR041S24F	116
4	24 Vdc	5...48 Vdc	2 A	(1) (3)	R42S24	XR042S24	114
4	24 Vdc	48...240 Vac	2 A	(1) (3)	R42T24	XR042T24	115
8	24 Vdc	5...48 Vdc	2 A	(1) (3) (4)	R81S24F	XR081S24F	116
8	24 Vdc	5...48 Vdc	2 A	(1) (3)	R82S24	XR082S24	114
8	24 Vdc	48...240 Vac	2 A	(1) (3)	R82T24	XR082T24	115
8	5...24 Vdc	12...24 Vdc	8 x 2.5 A	(2) (5)	COP082	XCOP082	117
16	24 Vdc	5...48 Vdc	2 A	(1) (3) (4)	R161S24F	XR161S24F	116
16	24 Vdc	5...48 Vdc	2 A	(1) (3)	R162S24	XR162S24	114
16	24 Vdc	48...240 Vac	2 A	(1) (3)	R162T24	XR162T24	115

### Notes

(1) pluggable relay version

(2) fixed relay version

(3) universal common, negative DC control, positive DC

(4) safety fuse on output

(5) electronic protection on output

on rail, space 4 mm from adjacent components

# Single solid state relay

- Fixed relay
- Reduced overall dimensions

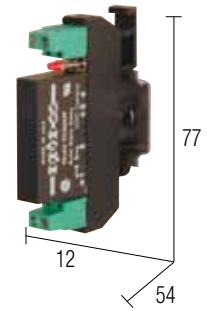

## NOTES

(1) Relay make and model are not final and may be replaced without notice. The technical details shown are to be considered typical.

## BLOCK DIAGRAM

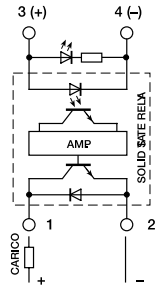

## BLOCK DIAGRAM

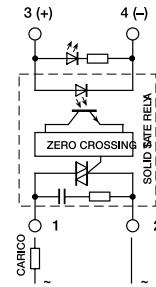

## VERSIONS

	Cat. No. XO332060	Cat. No. XO332240
Pluggable relay	—	—
Fixed relay	<b>O332060</b>	<b>O332240</b>

## INPUT TECHNICAL DATA

Input voltage	4...30 Vdc	4...30 Vdc
Signal 1 input level	> 3 Vdc	> 3 Vdc
Signal 0 input level	< 1 Vdc	< 1 Vdc
Power consumption	< 35 mA	< 35 mA
Commutation frequency	100 Hz max	100 Hz max
Connection type	2.5 mm <sup>2</sup> fixed screw terminal blocks	2.5 mm <sup>2</sup> fixed screw terminal blocks

## OUTPUT TECHNICAL DATA

Output voltage	5...60 Vdc	24...240 Vac (zero crossing)
Permanent load current	3 A at 20°C (see graph)	4 A at 20°C (see graph)
Max current	4 A to 20°C (5 A / 5 s - 25 A / 10 ms)	5 A to 20°C (6 A / 5 s - 25 A / 10 ms)
Leakage current with signal 0	1 mA	5 mA
OFF/ON switching time	—	10 ms max
Protection circuit	diode	RC filters
Connection type	2.5 mm <sup>2</sup> fixed screw terminal blocks	2.5 mm <sup>2</sup> fixed screw terminal blocks

## GENERAL TECHNICAL DATA

Operating temperature range	-20...+60°C (see graph)	-20...+60°C (see graph)
Coil isolation/contacts	4 kVac / 60 s	4 kVac / 60 s
Protection degree	IP 00 IEC529, EN60529	IP 00 IEC529, EN60529
Reference Standards	IEC 664-1, DIN VDE 0110.1	IEC 664-1, DIN VDE 0110.1
Degree of pollution	2	2
Surge category	III	III
Power/status indicator	LED	LED
Housing material	UL94V-0 polyamide	UL94V-0 polyamide
Approximate weight	36 g	36 g
Mounting information	on rail, space 4 mm from adjacent components	on rail, space 4 mm from adjacent components

## MOUNTING ACCESSORIES

Mounting rail compliant with IEC60715/TH35	<b>PR/3/AC, PR/3/AS</b>	<b>PR/3/AC, PR/3/AS</b>
Mounting rail type according to IEC60715/G32	<b>PR/DIN/AC - PR/DIN/AS - PR/DIN/AL</b>	<b>PR/DIN/AC - PR/DIN/AS - PR/DIN/AL</b>
Spare part relay (1)	—	—
Jumper	red white blue	— — —

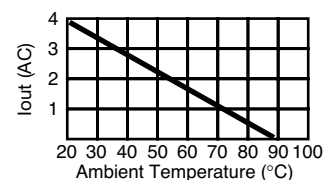
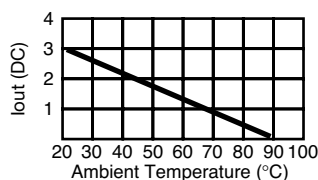

# Single solid state relay CM series

- Low cost
- For switching loads in DC (version S)
- Pluggable relay

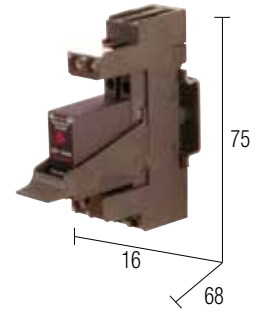
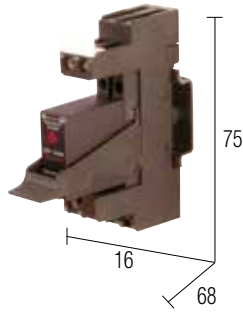

## NOTES

- (1) Relay make and model are not final and may be replaced without notice. The technical details shown are to be considered typical
- (2) Version made to order (not kept in stock); contact our sales office for availability.

This series can be mounted side-by-side without the need for spacing to allow the relay to cool.

## BLOCK DIAGRAM

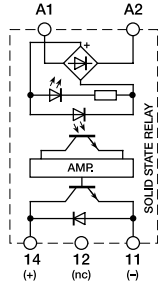

## BLOCK DIAGRAM

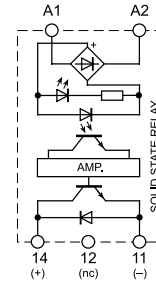

## VERSIONS

Pluggable relay  
Fixed relay

Cat. No. XCM1S024

CM1S024 (2)

—

Cat. No. XCM1S024E

CM1S024E (2)

—

## INPUT TECHNICAL DATA

Input voltage	24 Vdc (19.2... 28.8 Vdc)
Signal 1 input level	> 19.2 Vdc
Signal 0 input level	< 1 Vdc
Power consumption (1 channel)	< 20 mA
Commutation frequency	100 Hz max
Connection type	2.5 mm <sup>2</sup> fixed screw terminal blocks

Input voltage	12-24 Vdc (10... 32 Vdc)
Signal 1 input level	> 10 Vdc
Signal 0 input level	< 10 Vdc
Power consumption (1 channel)	< 16 mA
Commutation frequency	100 Hz max
Connection type	2.5 mm <sup>2</sup> fixed screw terminal blocks

## OUTPUT TECHNICAL DATA

Output voltage	3...50 Vdc
Permanent load current	2 A to 40°C
Max current	8 A / 10 ms
Leakage current with signal 0	0.1 mA
OFF/ON switching time	100 μs / 1 ms
Protection circuit	diode
Connection type	2.5 mm <sup>2</sup> fixed screw terminal blocks

Output voltage	0...35 Vdc
Permanent load current	5 A at 60°C
Max current	120 A (peak)
Leakage current with signal 0	10 μA
OFF/ON switching time	50 μs / 250 μs
Protection circuit	diode
Connection type	2.5 mm <sup>2</sup> fixed screw terminal blocks

## GENERAL TECHNICAL DATA

Operating temperature range	-20...+80°C over 40°C apply a derating of 0.04A/°C
Coil isolation/contacts	2.5 kVac / 60 s
Protection degree	IP 00 IEC529, EN60529
Reference Standards	IEC 664-1, DIN VDE 0110.1
Degree of pollution	3
Surge category	III
Power/status indicator	LED
Housing material	UL94V-0 polyamide
Approximate weight	—
Mounting information	vertical on rails, side by side

Operating temperature range	-20...+80°C over 60°C apply a derating of 0.05A/°C
Coil isolation/contacts	2.5 kVac / 60 s
Protection degree	IP 00 IEC529, EN60529
Reference Standards	IEC 664-1, DIN VDE 0110.1
Degree of pollution	3
Surge category	III
Power/status indicator	LED
Housing material	UL94V-0 polyamide
Approximate weight	—
Mounting information	vertical on rails, side by side

## MOUNTING ACCESSORIES

Mounting rail compliant with IEC60715/TH35	PR/3/AC, PR/3/AS
Mounting rail type according to IEC60715/G32	—
Spare part relay (1)	Cat. No. 8904404
Jumper	Cat. No. XCMB16B
	—
	—

Mounting rail compliant with IEC60715/TH35	PR/3/AC, PR/3/AS
Mounting rail type according to IEC60715/G32	—
Spare part relay (1)	Cat. No. 8904402
Jumper	Cat. No. XCMB16B
	—
	—



Jumper

# Single solid state relay CM series

- Low cost
- For switching loads in DC (version S)
- Pluggable relay

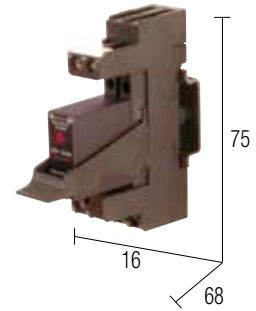
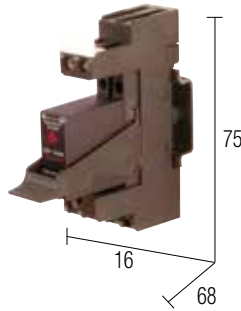

## NOTES

- (1) Relay make and model are not final and may be replaced without notice. The technical details shown are to be considered typical
- (2) Version made to order (not kept in stock); contact our sales office for availability.

This series can be mounted side-by-side without the need for spacing to allow the relay to cool.

## BLOCK DIAGRAM

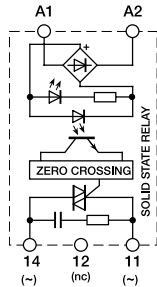

## BLOCK DIAGRAM

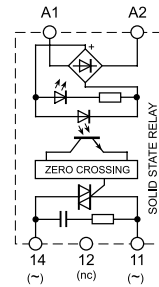

## VERSIONS

Pluggable relay  
Fixed relay

Cat. No. XCM1T024

CM1T024 (2)

Cat. No. XCM1T024E

CM1T024E (2)

## INPUT TECHNICAL DATA

Input voltage	24 Vdc (19.2... 28.8 Vdc)
Signal 1 input level	> 19.2 Vdc
Signal 0 input level	< 1 Vdc
Power consumption (1 channel)	< 20 mA
Commutation frequency	100 Hz max
Connection type	2.5 mm <sup>2</sup> fixed screw terminal blocks

Input voltage	12-24 Vdc (10... 32 Vdc)
Signal 1 input level	> 10 Vdc
Signal 0 input level	< 10 Vdc
Power consumption (1 channel)	< 16 mA
Commutation frequency	100 Hz max
Connection type	2.5 mm <sup>2</sup> fixed screw terminal blocks

## OUTPUT TECHNICAL DATA

Output voltage	48...280 Vac (zero crossing)
Permanent load current	3 A to 40°C
Max current	120 A / 10 ms
Leakage current with signal 0	5 mA
OFF/ON switching time	1/2 cycle + 1 ms
Protection circuit	—
Connection type	2.5 mm <sup>2</sup> fixed screw terminal blocks

Output voltage	12...275 Vac (zero crossing)
Permanent load current	3 A at 60°C
Max current	120 A (peak)
Leakage current with signal 0	1 mA
OFF/ON switching time	50 μs / 250 μs
Protection circuit	—
Connection type	2.5 mm <sup>2</sup> fixed screw terminal blocks

## GENERAL TECHNICAL DATA

Operating temperature range	-20...+80°C over 40°C apply a derating of 0.05A/°C
Coil isolation/contacts	2.5 kVac / 60 s
Protection degree	IP 00 IEC529, EN60529
Reference Standards	IEC 664-1, DIN VDE 0110.1
Degree of pollution	3
Surge category	III
Power/status indicator	LED
Housing material	UL94V-0 polyamide
Approximate weight	—
Mounting information	vertical on rails, side by side

Operating temperature range	-20...+80°C over 40°C apply a derating of 0.025A/°C
Coil isolation/contacts	2.5 kVac / 60 s
Protection degree	IP 00 IEC529, EN60529
Reference Standards	IEC 664-1, DIN VDE 0110.1
Degree of pollution	3
Surge category	III
Power/status indicator	LED
Housing material	UL94V-0 polyamide
Approximate weight	—
Mounting information	vertical on rails, side by side

## MOUNTING ACCESSORIES

Mounting rail compliant with IEC60715/TH35	PR/3/AC, PR/3/AS
Mounting rail type according to IEC60715/G32	—
Spare part relay (1)	Cat. No. 8904405
Jumper	Cat. No. XCMB16B
	—
	—

Mounting rail compliant with IEC60715/TH35	PR/3/AC, PR/3/AS
Mounting rail type according to IEC60715/G32	—
Spare part relay (1)	Cat. No. 8904403
Jumper	Cat. No. XCMB16B
	—
	—



Jumper

# Solid State Relay with output protection

- Protection against short circuit, overload, overtemperature
- Input and output status LED
- Output extravoltage suppressor diode
- Extralow current absorbing
- Compact dimension

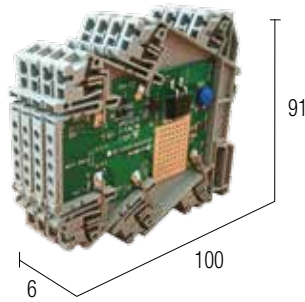

## NOTES

(1) La corrente massima dipende dal numero di uscite che sono contemporaneamente attive e dalla temperatura ambiente.  
 (2) The protection cuts off the output current, the yellow LED turns off or reduces its light, the output turns on automatically when the overload is removed. The current limiting depending also by the operating temperature, for more accuracy or to protect cables with small section or rated current lower than the maximum current, an external fuse must be provided.

## BLOCK DIAGRAM

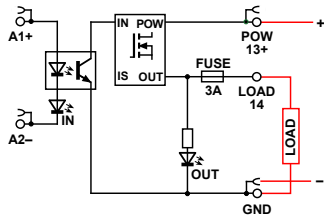

## BLOCK DIAGRAM

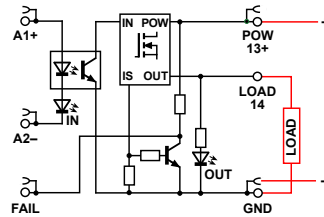

## BLOCK DIAGRAM

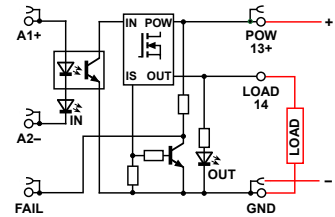

## ORDER CODE

Model	XCKS024DC024DC03 CKS-024DC/024DC/03	XCKS024DC024DC05 CKS-024DC/024DC/05	XCKS024DC024DC10 CKS-024DC/024DC/10
<b>INPUT TECHNICAL DATA</b>			
Input voltage	5...24 Vdc (4.7...32 Vdc)	5...24 Vdc (4.7...32 Vdc)	5...24 Vdc (4.7...32 Vdc)
Level 1 (high) input signal	> 4.5 Vdc	> 4.5 Vdc	> 4.5 Vdc
Level 0 (low) input signal	< 4.2 Vdc	< 4.2 Vdc	< 4.2 Vdc
Rated current	≤ 10 mA at 24 Vdc	≤ 10 mA at 24 Vdc	≤ 10 mA at 24 Vdc
Input channels	1	1	1
<b>OUTPUT TECHNICAL DATA</b>			
Output voltage	5...24 Vdc (5...32 Vdc)	5...24 Vdc (5...32 Vdc)	5...24 Vdc (5...32 Vdc)
Continuous current	3 A / 24 Vdc at 45°C (1) 5 A / 24 Vdc at 20°C (1)	8 A / 24 Vdc at 45°C (1) 5 A / 24 Vdc at 55°C (1)	10 A / 24 Vdc at 45°C (1) 15 A / 24 Vdc at 20°C (1)
Maximum current	5 A / 2 s +/- 10% at 25°C (1)	21 A / 100 ms at 25°C (1)	21 A / 100 ms at 25°C (1)
Min. applicable load	5 V / 10 mA	5 V / 10 mA	5 V / 10 mA
Leakage current 0 signal	< 25 µA at 24 Vdc	< 25 µA at 24 Vdc	< 25 µA at 24 Vdc
Isolation between open contacts	—	—	—
Internal protection	auto resettable fuse / suppressor diode	electronic against short circuit, overload, overtemperature (2) / suppressor diode	—
External protection	fuse 3 A max.	fuse 5 A max.	fuse 10 A max.
<b>GENERAL TECHNICAL DATA</b>			
Operating temperature	-20...+60°C	-20...+60°C with thermal protection (2)	-20...+60°C with thermal protection (2)
I/O isolation	3 kVac / 60 s	3 kVac / 60 s	3 kVac / 60 s
Max. switching frequency	200 Hz max.	200 Hz max.	200 Hz max.
Status display	LED green IN / LED yellow OUT	LED green IN / LED yellow OUT / Fail	LED green IN / LED yellow OUT / Fail
Protection degree	—	IP20 IEC529 EN60529 (with end plate on the last module)	—
Reference Standard	—	—	—
Pollution degree	2	2	2
Overvoltage category	II	II	II
Connection terminals	2.5 mm <sup>2</sup> (AWG26-14) fixed spring type	2.5 mm <sup>2</sup> (AWG26-14) fixed spring type	2.5 mm <sup>2</sup> (AWG26-14) fixed spring type
Housing material	Polyamide UL94V-0	Polyamide UL94V-0	Polyamide UL94V-0
Approx. weight	30 g (1.06 oz)	30 g (1.06 oz)	30 g (1.06 oz)
Mounting information	Vertical on rail adjacent without gap	Vertical on rail adjacent without gap	Vertical on rail adjacent without gap
<b>MOUNTING ACCESSORIES</b>			
Mounting rail type IEC60715/TH35-7,5	PR/3/AC, PR/3/AC/ZB, PR/3/AS, PR/3/AS/ZB	PR/3/AC, PR/3/AC/ZB, PR/3/AS, PR/3/AS/ZB	PR/3/AC, PR/3/AC/ZB, PR/3/AS, PR/3/AS/ZB
Mounting rail type IEC60715/G32	—	—	—
Replacement relay	—	—	—
Plug-in jumper	2 poles 3 poles 5 poles 10 poles 42 poles	PTC/4/02 Cod. PTC0402 PTC/4/03 Cod. PTC0403 PTC/4/05 Cod. PTC0405 PTC/4/10 Cod. PTC0410 PTC/4/00 Cod. PTC0400	PTC/4/02 Cod. PTC0402 PTC/4/03 Cod. PTC0403 PTC/4/05 Cod. PTC0405 PTC/4/10 Cod. PTC0410 PTC/4/00 Cod. PTC0400
Marking tags	CNU/8/51 Cat. No. NU0851	CNU/8/51 Cat. No. NU0851	CNU/8/51 Cat. No. NU0851
End plate	CK/PT Cat. No. XCKPT	CK/PT Cat. No. XCKPT	CK/PT Cat. No. XCKPT

# Solid State Relay with output for AC loads

- Output extravoltage varistor
- Extralow current absorbing
- Compact dimension

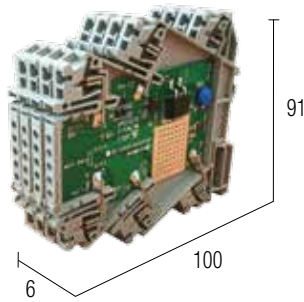

## NOTES

(1) Maximum output current of each channel depends on surrounding air temperature, on the number of output contemporarily active and on the current flowing through them.

(2) An external fuse must be provided to prevent damage to the circuit and to the cables. The non-resettable internal fuse (calibrated track) has the only purpose to avoid damages in the even of failure of the external protection.

## BLOCK DIAGRAM

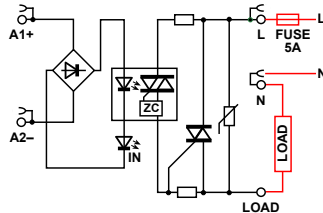

## ORDER CODE

**XCKS024DC230AC05**

Model

**CKS-024DC/230AC/05**

## INPUT TECHNICAL DATA

Input voltage	12...24 Vdc (9...30 Vdc / 9...30Vac)
Level 1 (high) input signal	> 8.5 Vdc
Level 0 (low) input signal	< 8 Vdc
Rated current	≤ 10 mA at 24 Vdc
Input channels	1

## OUTPUT TECHNICAL DATA

Output voltage	230 Vac (20...265 Vac)
Continuous current	5 A / 230 Vac at 45°C (1)
Maximum current	6 A
Min. applicable load	24 Vac / 10 mA
Leakage current 0 signal	< 25 µA at 24 Vdc
Isolation between open contacts	—
Internal protection	not replaceable fuse 10 A / varistor (2)
External protection	fuse 5 A max.

## GENERAL TECHNICAL DATA

Operating temperature	-20 ... +45°C
I/O isolation	3 kVac / 60 s
Max. switching frequency	—
Status display	LED green IN
Protection degree	IP20 IEC529 EN60529 (with end plate on the last module)
Reference Standard	—
Pollution degree	2
Overvoltage category	II
Connection terminals	2.5 mm <sup>2</sup> (AWG26-14) fixed spring type
Housing material	Polyamide UL94V-0
Approx. weight	30 g (1.06 oz)
Mounting information	vertical on rail adjacent without gap

## MOUNTING ACCESSORIES

Mounting rail type IEC60715/TH35-7,5	<b>PR/3/AC, PR/3/AC/ZB, PR/3/AS, PR/3/AS/ZB</b>	
Mounting rail type IEC60715/G32	—	
Replacement relay	—	
Plug-in jumper	2 poles	PTC/4/02 Cod. PTC0402
	3 poles	PTC/4/03 Cod. PTC0403
	5 poles	PTC/4/00 Cod. PTC0400
	10 poles	PTC/4/10 Cod. PTC0410
	42 poles	PTC/4/00 Cod. PTC0400
Marking tags	CNU/8/51	Cat. No. NU0851
End plate	CK/PT	Cat. No. XCKPT



# Solid state single relay with SPDT output

- 10...40 Vdc operating voltage
- Output with exchange contact simulation
- 5...48 Vdc 500 mA output voltage
- Commutation frequency up to 1 KHz
- 3.75 kV Input/Output isolation

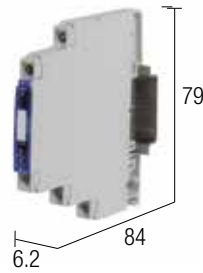

## NOTES

Opto-isolators offer many advantages over electromechanical relays, such as increased electrical duration, super-high commutation frequency, insensitivity to vibrations, broad operating range and low power consumption.

Unfortunately, solid state relays are only able to switch a signal by simulating the NA contact of a relay, whereas this product, thanks to its integrated technology, offers all the benefits of solid state relays and eliminates the need for an NC contact.

## BLOCK DIAGRAM

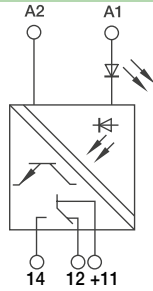

## VERSIONS

Cat. No. X766083

Pluggable relay

Fixed relay

CWOT 6-2083

## INPUT TECHNICAL DATA

Input signal	24 Vdc (range 10...40 Vdc)
Signal 1 input level (ON)	>5 Vdc
Signal 0 input level (OFF)	<5 Vdc
Power consumption	6 mA
Protection device	suppression diode

## OUTPUT TECHNICAL DATA

Output signal	5...48 Vdc
Load current	10...500 mA
Switching delay	12 μs ON / 12 μs OFF
Protection device	suppression diode
Output type	NPN/PNP transistor with exchange contact simulation

## GENERAL TECHNICAL DATA

Operating temperature range	-25 ...+60°C
Input/output isolation	3.75 kVac / 60 s
Max commutation frequency	<1 KHz
Protection degree	IP 20 IEC529 EN60529
Reference Standards	IEC 664-1, DIN VDE
Degree of pollution	2
Surge category	III
Connection type	2.5 mm <sup>2</sup> fixed screw terminal blocks
Case material	PPE
Approximate weight	29 g
Mounting information	vertical on rails, side by side

## MOUNTING ACCESSORIES

Mounting rail compliant with IEC60715/TH35-7.5	<b>PR/3/AC, PR/3/AC/ZB, PR/3/AS, PR/3/AS/ZB</b>
Mounting rail type according to IEC60715/G32	—
Spare part relay (1)	—
Jumper	—
Marking tag	neutral
	marked
	marked
End section	—

# Signal optoisolators

- Suitable for the isolation and transmission of high-frequency digital signals
- Status LED
- 5, 12 and 24 Vdc operating voltages
- Input/Output isolation

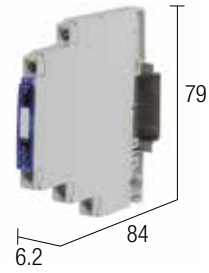
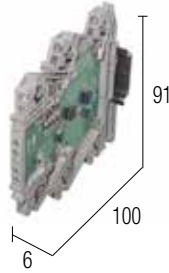

## NOTES

(1) Product made to order (not kept in stock).  
Used in high-frequency digital signal transmission circuits such as counters, encoders, etc., it eliminates the influence of different reference potentials (mass or ground) on the signal and attenuates the influence of EMI interference, particularly with low-level signals (e.g. 5 Vdc), as well as allowing for secure and clean transmission to greater distances; the use of balanced shielded conductors (two signal conductors plus shield) is however recommended; for frequencies above 25 Hz, the input status LED will be constantly lit, indicating that a transmission is in process.

## BLOCK DIAGRAM

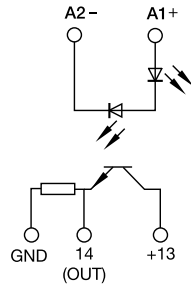

## BLOCK DIAGRAM

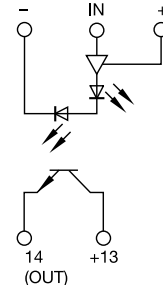

## VERSIONS

Cat. No. XCKS1S

CKS1S (1)

Cat. No. X766082

CWOT 6-6082

## INPUT TECHNICAL DATA

Input signal	3...30 Vdc
Signal 1 input level (ON)	≥ 3 Vdc
Signal 0 input level (OFF)	≤ 3 Vdc
Power consumption	≤ 10 mA at 24 Vdc

Input signal	4.5...28 Vdc
Signal 1 input level (ON)	>4.2 Vdc
Signal 0 input level (OFF)	<2.7 Vdc
Power consumption	0.1 mA

## OUTPUT TECHNICAL DATA

Output signal	3...30 Vdc
Permanent load current	80 mA / 30 Vdc at 25°C
Min. applicable load	10 mV / 2 mA
Switching delay	—

Output signal	5...48 Vdc
Permanent load current	10...500 mA
Min. applicable load	—
Switching delay	12 μs ON / 12 μs OFF

## GENERAL TECHNICAL DATA

Operating temperature range	-20...+60°C
Input/output isolation	3 kVac / 60 s
Max commutation frequency	20 kHz max duty cycle 50/50, 70/30 max
Protection degree	IP 20 IEC529 EN60529
Reference Standards	IEC 664-1, EN50081-1
Degree of pollution	2
Surge category	II
Connection type	2.5 mm <sup>2</sup> , AWG26-14 spring type
Housing material	UL94V-0 polyamide
Approximate weight	32 g
Mounting information	vertical on rails, side by side

Operating temperature range	-25...+60°C
Input/output isolation	3.75 kVac / 60 s
Max commutation frequency	<20 kHz
Protection degree	IP 20 IEC529 EN60529
Reference Standards	IEC 664-1, DIN VDE
Degree of pollution	2
Surge category	III
Connection type	2.5 mm <sup>2</sup> , AWG26-14 screw type
Housing material	PPE
Approximate weight	29 g
Mounting information	vertical on rails, side by side

## MOUNTING ACCESSORIES

Mounting rail compliant with IEC60715/TH35-7.5	PR/3/AC, PR/3/AC/ZB, PR/3/AS, PR/3/AS/ZB
Mounting rail type according to IEC60715/G32	—
Spare part relay (1)	—
Jumper	Cat. No. PTCK42 (42 poles)
Marking tag	neutral marked marked
End section	Cat. No. XCKPT

PR/3/AC, PR/3/AC/ZB, PR/3/AS, PR/3/AS/ZB

Mounting rail compliant with IEC60715/TH35-7.5	—
Mounting rail type according to IEC60715/G32	—
Spare part relay (1)	—
Jumper	—
Marking tag	—
End section	—

# Multi-solid state relay modules

- For switching loads in DC
- Pluggable relay

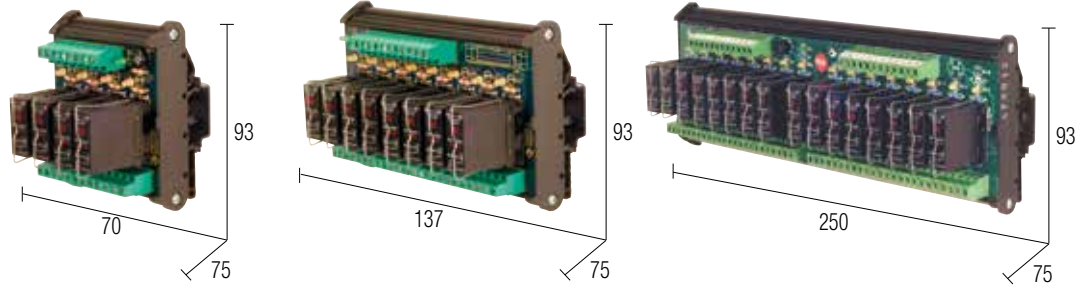

## NOTES

- (1) Relay make and model are not final and may be replaced without notice. The technical details shown are to be considered typical.  
 (2) Version made to order (not kept in stock); contact our sales office for availability.

### POWER SUPPLY COMPATIBILITY

A1 = +	A2 = -	negative common
A1 = -	A2 = +	positive common

## BLOCK DIAGRAM

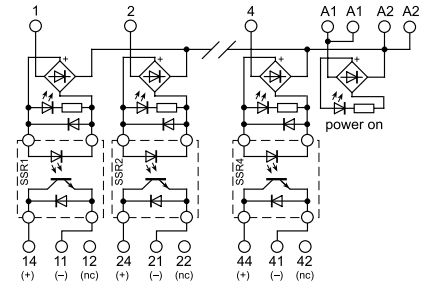

4 relay module

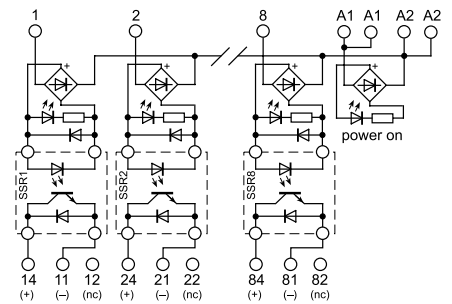

8 relay module

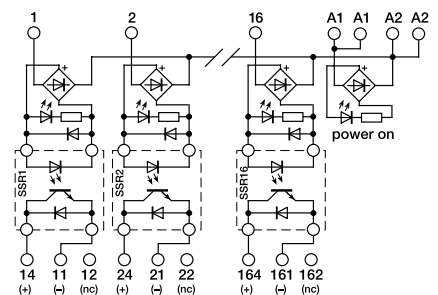

16 relay module

## VERSIONS

4 relay module

8 relay module

16 relay module

Cat. No. XR042S24	Cat. No. XR082S24	Cat. No. XR162S24
R42S24 (2)	R82S24 (2)	R162S24 (2)

## INPUT TECHNICAL DATA

Input voltage	24 Vdc (19.2...28.8 Vdc)
Signal 1 input level	> 19.2 Vdc
Signal 0 input level	< 1 Vdc
Power consumption (1 channel)	< 20 mA
Commutation frequency	100 Hz max

## OUTPUT TECHNICAL DATA

Output voltage	3...50 Vdc
Permanent load current	2 A to 40°C
Max current	8 A / 10 ms
Leakage current with signal 0	0.1 mA
OFF/ON switching time	100 µs / 1 ms
Protection circuit	diode
Max. fuse current	—

## GENERAL TECHNICAL DATA

Operating temperature range	-20...+80°C over 40°C apply a derating of 0.04A/°C
Input/Output isolation	2.5 kVdc / 60 s
Isolation between output terminal blocks	1 kVdc / 60 s (between open contact poles)
Protection degree	IP 00 IEC 529, EN60529
Surge category/degree of pollution	III / 2
Reference Standards	IEC 664-1, DIN VDE 0110.1
Power/status indicator	Green LED / Yellow LED
Connection type	2.5 mm <sup>2</sup> fixed screw terminal blocks and FLAT connector
Housing material	UL94V-0 plastic
Approximate weight	207 g   379 g   756 g
Mounting information	on rails, side by side

## MOUNTING ACCESSORIES

Mounting rail compliant with IEC60715/TH35	PR/3/AC, PR/3/AC/ZB, PR/3/AS, PR/3/AS/ZB
Mounting rail type according to IEC60715/G32	PR/DIN/AC - PR/DIN/AS - PR/DIN/AL
Spare part relay (1)	Cat. No. 8904404
Jumper	—

# Multi-solid state relay modules

- For switching loads in DC
- Pluggable relay

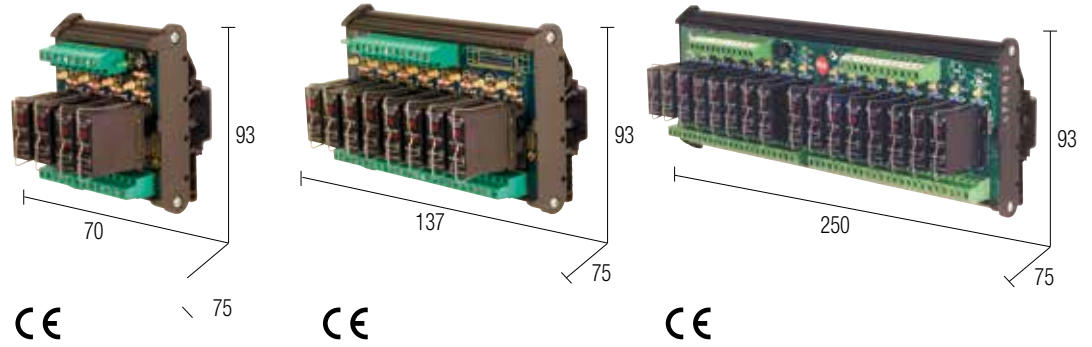

## NOTES

- (1) Relay make and model are not final and may be replaced without notice. The technical details shown are to be considered typical.  
 (2) Version made to order (not kept in stock); contact our sales office for availability.

### POWER SUPPLY COMPATIBILITY

A1 = +	A2 = -	negative common
A1 = -	A2 = +	positive common

## BLOCK DIAGRAM

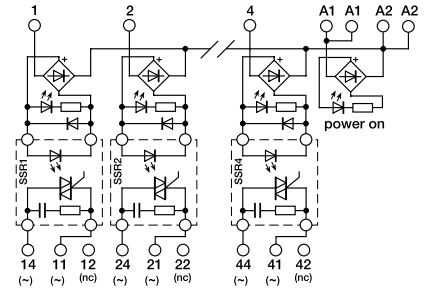

4 relay module

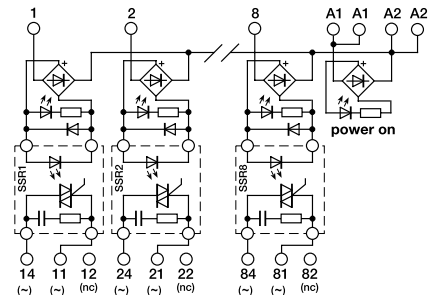

8 relay module

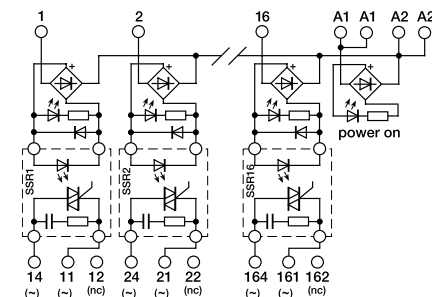

16 relay module

## VERSIONS

	Cat. No. XR042T24	Cat. No. XR082T24	Cat. No. XR162T24
4 relay module	R42T24 (2)		
8 relay module		R82T24 (2)	
16 relay module			R162T24 (2)

## INPUT TECHNICAL DATA

Input voltage	24 Vdc (19.2...28.8 Vdc)
Signal 1 input level	> 19.2 Vdc
Signal 0 input level	< 1 Vdc
Power consumption (1 channel)	< 20 mA
Commutation frequency	100 Hz max

## OUTPUT TECHNICAL DATA

Output voltage	48...240 Vac (zero crossing)
Permanent load current	3 A to 40°C
Max current	120 A / 10 ms
Leakage current with signal 0	5 mA
OFF/ON switching time	1/2 cycle + 1 ms
Protection circuit	—
Max. fuse current	—

## GENERAL TECHNICAL DATA

Operating temperature range	-20...+80°C over 40°C apply a derating of 0.05A/°C
Coil isolation/contacts	2.5 kVac / 60 s
Protection degree	1 kVac / 60 s (between open contact poles)
Reference Standards	IP 00 IEC 529, EN60529
Degree of pollution	III / 2
Surge category	IEC 664-1, DIN VDE 0110.1
Relay model (1)	Green LED / Yellow LED
Power/status indicator	2.5 mm <sup>2</sup> fixed screw terminal blocks and FLAT connector
Housing material	UL94V-0 plastic
Approximate weight (4/8/16 relay)	207 g   379 g   756 g
Mounting information	on rails, side by side

## MOUNTING ACCESSORIES

Mounting rail compliant with IEC60715/TH35	PR/3/AC, PR/3/AC/ZB, PR/3/AS, PR/3/AS/ZB
Mounting rail type according to IEC60715/G32	PR/DIN/AC - PR/DIN/AS - PR/DIN/AL
Spare part relay (1)	Cat. No. 8904405
Jumper	—

# Multi-solid state relay modules with fuse

- For switching loads in DC
- Safety fuse on output
- Pluggable relay

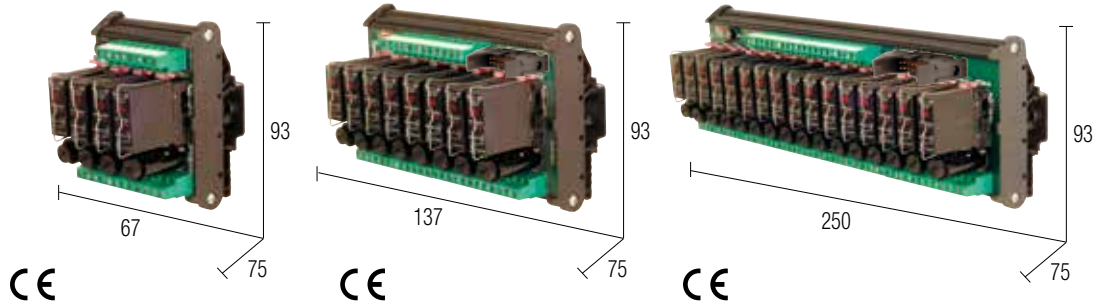

## NOTES

- (1) Relay make and model are not final and may be replaced without notice. The technical details shown are to be considered typical.
- (2) The fuse must be of a suitable size for the load. The max. value of 6.3 A refers to fuses compliant with EN60127 and at the nominal approved current of the fuse holder. Larger fuses can cause damage to the fuse holder and to the module.
- (3) Version made to order (not kept in stock); contact our sales office for availability.

### POWER SUPPLY COMPATIBILITY

A1 = +	A2 = -	negative common
A1 = -	A2 = +	positive common

## BLOCK DIAGRAM

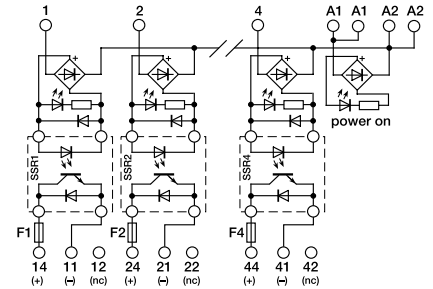

4 relay module

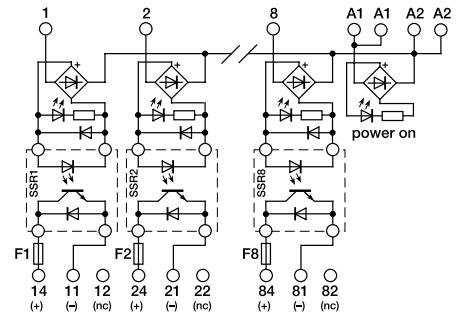

8 relay module

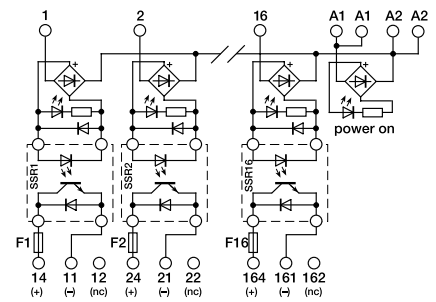

16 relay module

## VERSIONS

4 relay module

8 relay module

16 relay module

Cat. No. XR041S24F	Cat. No. XR081S24F	Cat. No. XR161S24F
R41S24F (3)	R81S24F (3)	R161S24F (3)

## INPUT TECHNICAL DATA

Input voltage	24 Vdc (19.2...28.8 Vdc)
Signal 1 input level	> 19.2 Vdc
Signal 0 input level	< 1 Vdc
Power consumption (1 channel)	< 20 mA
Commutation frequency	100 Hz max

## OUTPUT TECHNICAL DATA

Output voltage	3...50 Vdc
Permanent load current	2 A to 40°C
Max current	8 A / 10 ms
Leakage current with signal 0	0.1 mA
OFF/ON switching time	100 µs / 1 ms
Protection circuit	diode
Max. fuse current	—

## GENERAL TECHNICAL DATA

Operating temperature range	-20...+80°C over 40°C apply a derating of 0.04A/°C
Input/Output isolation	2.5 kVac / 60 s
Isolation between output terminal blocks	1 kVac / 60 s (between open contact poles)
Protection degree	IP 00 IEC 529, EN60529
Surge category/degree of pollution	III / 2
Reference Standards	IEC 664-1, DIN VDE 0110.1
Power/status indicator	Green LED / Yellow LED
Connection type	2.5 mm <sup>2</sup> fixed screw terminal blocks and FLAT connector
Housing material	UL94V-0 plastic
Approximate weight	207 g   379 g   756 g
Mounting information	on rails, side by side

## MOUNTING ACCESSORIES

Mounting rail compliant with IEC60715/TH35	PR/3/AC, PR/3/AC/ZB, PR/3/AS, PR/3/AS/ZB
Mounting rail type according to IEC60715/G32	PR/DIN/AC - PR/DIN/AS - PR/DIN/AL
Spare part relay (1)	Cat. No. 8904404
Jumper	—

# Solid state 24 Vdc relay modules with electronic protection

- Nominal output current 8 x 2.5 A / 5 - 33 Vdc
- outputs protected against short-circuit, overload, over temperature and surge;
- Negative common 12-24 Vdc input, 8 status LEDs K1 and K8
- 8 "output OK" LED indicators, reverse polarity protection diode on input and output
- Width 70 mm

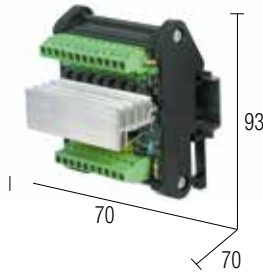

Item available until supplies last

## NOTES

- (1) Maximum current depends on the number of simultaneously active outputs and the ambient temperature; the value shown was measured with 4 active and 4 non-active outputs.
- (2) Outputs are protected against short-circuit/overload and overtemperature; safety activation is indicated by a dimly lit or off output side status LED; once the short-circuit/overload is eliminated, the output is restored automatically.

## BLOCK DIAGRAM

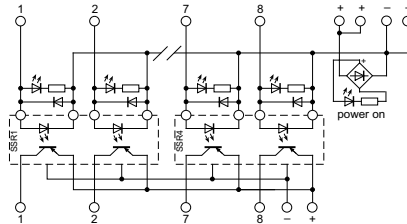

## VERSIONS

- 4 relay module
- 8 relay module
- 16 relay module

Cat. No. XCOP082

COP082

## INPUT TECHNICAL DATA

Input voltage	<b>5-24 Vdc</b> (range 4.2...32 Vdc) negative common
Signal 1 input level	> 3.5 Vdc
Signal 0 input level	< 3.5 Vdc
Power consumption (1 channel)	5 mA ±10%.
Commutation frequency	500 Hz

## OUTPUT TECHNICAL DATA

Output voltage	12-24 Vdc, (range 5...32 Vdc) negative common
Permanent load current	8 x 2.5 A at 25°C (1)
Max current	4.4 A
Leakage current with signal 0	25 µA max at 24Vdc
OFF/ON switching time	200 Hz (T on < 500 µs / T off < 500 µs)
Protection circuit	electronic short-circuit/overload/thermal (2)
Min. applicable load	5.2 Vdc/ 100 mA

## GENERAL TECHNICAL DATA

Operating temperature range	-20...-60°C (with thermal protection) (2)
Input/Output isolation	2.5 kVac / 60 s
Isolation between output terminal blocks	1 kVac / 60 s (between open contact poles)
Protection degree	IP 00 IEC 529, EN60529
Surge category/degree of pollution	III / 2
Reference Standards	IEC 664-1, DIN VDE 0110.1
Power/status indicator	Green LED (DC OK) / Yellow LED (output OK)
Connection type	2.5 mm <sup>2</sup> fixed screw terminal blocks
Housing material	UL94V-0 plastic
Approximate weight	
Mounting information	on rails, side by side

## MOUNTING ACCESSORIES

Mounting rail compliant with IEC60715/TH35	PR/3/AC, PR/3/AC/ZB, PR/3/AS, PR/3/AS/ZB
Mounting rail type according to IEC60715/G32	PR/DIN/AC - PR/DIN/AS - PR/DIN/AL
Spare part relay (1)	—
Jumper	—



# Quick passive interface selection table

These tables are used for quickly identifying items and verifying whether all of the product's technical details satisfy the set requirements.

## D-Sub / Terminal blocks

Versions	Dimensions AxBxC	Type	Type	Cat. No.	Page
9 poles	37x66x93	(6)	ISD09FM	XISD09FM	119
		(5)	ISD09PF	XISD09PF	119
		(8)	ISD09PM	XISD09PM	119
15 poles	47x66x93	(6)	ISD15FM	XISD15FM	119
		(5)	ISD15PF	XISD15PF	119
		(8)	ISD15PM	XISD15PM	119
25 poles	70x66x93	(6)	ISD25FM	XISD25FM	119
		(5)	ISD25PF	XISD25PF	119
		(8)	ISD25PM	XISD25PM	119
		(5) (11)	CPD25F	XCPD25F	119
		(8) (11)	CPD25M	XCPD25M	119
37 poles	107x66x93	(6)	ISD37FM	XISD37FM	119
		(5)	ISD37PF	XISD37PF	119
		(8)	ISD37PM	XISD37PM	119
		(5) (11)	CPD37F	XCPD37F	120
		(8) (11)	CPD37M	XCPD37M	120
50 poles	92x80x93	(5) (11)	CPD50F	XCPD50F	120
		(8) (11)	CPD50M	XCPD50M	120

## Diode-holders

Versions	Dimensions AxBxC	Type	Type	Cat. No.	Page
8 diodes	25x60x76	(4)	CDM08CS	XCDM08CS	124
		(1)	CDM08AC	XCDM08AC	125
		(2)	CDM08CC	XCDM08CC	125
16 diodes	50x65x93	(4)	CDM16CS	XCDM16CS	124
		(1)	CDM16AC	XCDM16AC	125
		(2)	CDM16CC	XCDM16CC	125
24 diodes	71x65x93	(4)	CDM24CS	XCDM24CS	124
		(1)	CDM24AC	XCDM24AC	125
		(2)	CDM24CC	XCDM24CC	125
		(2)	CDM24CC	XCDM24CC	125

## Lamp tester and LED tester

Versions	Dimensions AxBxC	Type	Type	Cat. No.	Page
8 diodes	45x65x93	(1)	CLT08AC	XCLT08AC	126
		(2)	CLT08CC	XCLT08CC	126
		(2)	CLP08CC	XCLP08CC	127
16 diodes	92x65x93	(1)	CLT16AC	XCLT16AC	126
		(2)	CLT16CC	XCLT16CC	126
		(2)	CLP16CC	XCLP16CC	127

## Flat / Terminal blocks

Versions	Dimensions AxBxC	Type	Type	Cat. No.	Page
10 poles	42x66x93	(8) (7)	IF10PML	XIF10PML	120
14 poles	48x66x93	(8) (7)	IF14PML	XIF14PML	121
16 poles	58x66x93	(8) (7)	IF16PML	XIF16PML	121
20 poles	70x66x93	(8) (7)	IF20PML	XIF20PML	121
		(8) (11)	CPC20M	XCPC20M	122
26 poles	86x66x93	(8) (7)	IF26PML	XIF26PML	121
		(8) (11)	CPC26M	XCPC26M	122
34 poles	107x66x93	(8) (7)	IF34PML	XIF34PML	121
		(8) (11)	CPC34M	XCPC34M	122
40 poles	122x66x93	(8) (7)	IF40PML	XIF40PML	121
		(8) (11)	CPC40M	XCPC40M	122
50 poles	92x80x93	(8) (11)	CPC50M	XCPC50M	122
60 poles	107x80x93	(8) (11)	CPC60M	XCPC60M	122
64 poles	117x80x93	(8) (11)	CPC64M	XCPC64M	122

## Component holders

Versions	Dimensions AxBxC	Type	Type	Cat. No.	Page
8 components	25x66x93	(10)	CCM08SV	XCCM08SV	123
8 components	25x66x93	(3)	CCM08CV	XCCM08CV	123
16 components	47x66x93	(10)	CCM16SV	XCCM16SV	123
16 components	47x66x93	(3)	CCM16CV	XCCM16CV	123
24 components	70x66x93	(10)	CCM24SV	XCCM24SV	123

### Key

- (1) common anode
- (2) common cathode
- (3) with common
- (4) feed-through
- (5) female connector

- (6) female + male connector
- (7) with LED
- (8) male connector
- (9) feed-throughs with Faston
- (10) feed-throughs with terminal blocks
- (11) small size

# Passive interfaces (D-Sub/terminal blocks) ISD Series

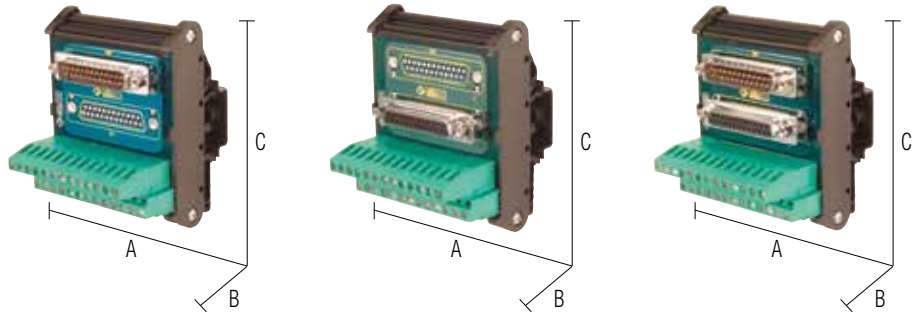

## NOTES

The modules allow signals originating on a wire with a d-sub connector to be transferred to terminal blocks.

Numbering is "pin-to-pin".

(1) Version made to order (not kept in stock); contact our sales office for availability.

## BLOCK DIAGRAM

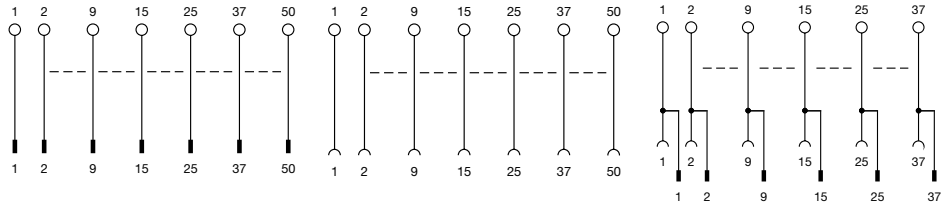

VERSIONS	DIMENSIONS (A x B x C)	male		female		male + female	
		Type	Cat. No.	Type	Cat. No.	Type	Cat. No.
9 poles	37x66x93	ISD09PM (1)	XISD09PM	ISD09PF (1)	XISD09PF	ISD09FM	XISD09FM
15 poles	47x66x93	ISD15PM (1)	XISD15PM	ISD15PF (1)	XISD15PF	ISD15FM	XISD15FM
25 poles	70x66x93	ISD25PM (1)	XISD25PM	ISD25PF (1)	XISD25PF	ISD25FM	XISD25FM
37 poles	107x66x93	ISD37PM (1)	XISD37PM	ISD37PF (1)	XISD37PF	ISD37FM	XISD37FM
GENERAL TECHNICAL DATA							
Applicable voltage		0...50 Vac / 0...75 Vdc		0...50 Vac / 0...75 Vdc		0...50 Vac / 0...75 Vdc	
Applicable current		2 A max		2 A max		2 A max	
Operating temperature range		-20...+60°C		-20...+60°C		-20...+60°C	
Protection degree		IP00 IEC529; EN60529		IP00 IEC529; EN60529		IP00 IEC529; EN60529	
Reference Standards		IEC 664-1; DIN VDE 0110.1		IEC 664-1; DIN VDE 0110.1		IEC 664-1; DIN VDE 0110.1	
Degree of pollution		2		2		2	
Surge category		II		II		II	
Housing material		UL94V-0 polyamide		UL94V-0 polyamide		UL94V-0 polyamide	
Connection type		2.5 mm <sup>2</sup> fixed screw terminal blocks		2.5 mm <sup>2</sup> fixed screw terminal blocks		2.5 mm <sup>2</sup> fixed screw terminal blocks	
Mounting information		vertical on rails, side by side		vertical on rails, side by side		vertical on rails, side by side	
MOUNTING ACCESSORIES							
Mounting rail compliant with IEC60715/TH35		PR/3/AC - PR/3/AS					
Mounting rail type according to IEC60715/G32		PR/DIN/AC - PR/DIN/AS - PR/DIN/AL					
Jumper	black	—					

# Passive interfaces (D-Sub/terminal blocks) CPD Series

- Small size

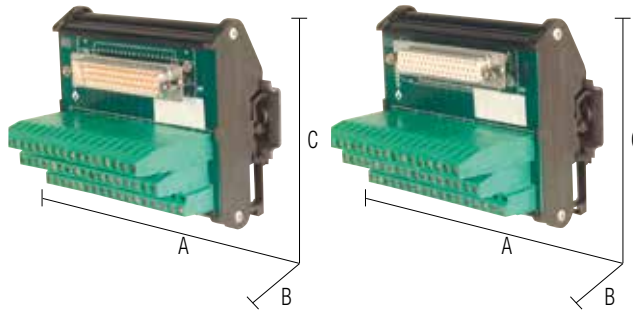

## NOTES

The modules allow signals originating on a wire with a d-sub connector to be transferred to terminal blocks.

Numbering is "pin-to-pin".

(1) Version made to order (not kept in stock); contact our sales office for availability.

## BLOCK DIAGRAM

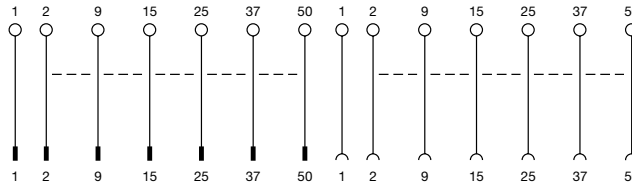

VERSIONS	DIMENSIONS (A x B x C)	male		female	
		Type	Cat. No.	Type	Cat. No.
25 poles	57x80x93	CPD25M	XCPD25M	CPD25F	XCPD25F
37 poles	77x80x93	CPD37M	XCPD37M	CPD37F	XCPD37F
50 poles	92x80x93	CPD50M (1)	XCPD50M	CPD50F (1)	XCPD50F

## GENERAL TECHNICAL DATA

Applicable voltage	0...50 Vac / 0...75 Vdc
Applicable current	2 A max
Operating temperature range	-20...+60°C
Protection degree	IP00 IEC529; EN60529
Reference Standards	IEC 664-1; DIN VDE 0110.1
Degree of pollution	2
Surge category	II
Housing material	UL94V-0 polyamide
Connection type	2.5 mm <sup>2</sup> fixed screw terminal blocks
Mounting information	vertical on rails, side by side

## MOUNTING ACCESSORIES

Mounting rail compliant with IEC60715/TH35	PR/3/AC - PR/3/AS
Mounting rail type according to IEC60715/G32	PR/DIN/AC - PR/DIN/AS - PR/DIN/AL
Jumper	black

# Passive interfaces (Flat-cable/terminal blocks) IF Series

- With warning light

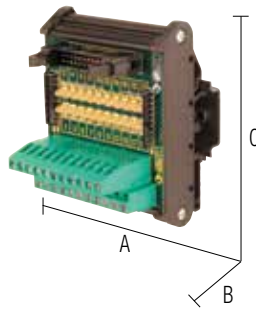

## NOTES

The modules allow signals originating on a flat cable to be transferred to terminal blocks using IDC connectors (with isolation perforation).

Numbering is "pin-to-pin".

(1) Version made to order (not kept in stock); contact our sales office for availability.

(2) Warning LEDs are configured for a nominal voltage of 24 Vdc and negative common

## BLOCK DIAGRAM

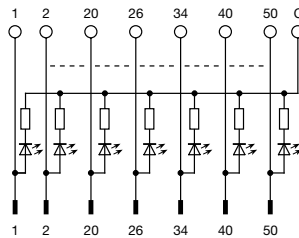

VERSIONS	DIMENSIONS (A x B x C)	with LED	
		Type	Cat. No.
10 poles	42x66x93	IF10PML (1)	XIF10PML
14 poles	48x66x93	IF14PML (1)	XIF14PML
16 poles	58x66x93	IF16PML (1)	XIF16PML
20 poles	70x66x93	IF20PML (1)	XIF20PML
26 poles	86x66x93	IF26PML (1)	XIF26PML
34 poles	107x66x93	IF34PML (1)	XIF34PML
40 poles	122x66x93	IF40PML (1)	XIF40PML

## GENERAL TECHNICAL DATA

Applicable voltage	12...24 Vdc ±10% (2)
Applicable current	750 mA max
Operating temperature range	-20...+60°C
Protection degree	IP00 IEC529; EN60529
Reference Standards	IEC 664-1; DIN VDE 0110.1
Degree of pollution	2
Surge category	II
Housing material	UL94V-0 polyamide
Connection type	2.5 mm <sup>2</sup> fixed screw terminal blocks
Mounting information	vertical on rails, side by side

## MOUNTING ACCESSORIES

Mounting rail compliant with IEC60715/TH35	PR/3/AC - PR/3/AS
Mounting rail type according to IEC60715/G32	PR/DIN/AC - PR/DIN/AS - PR/DIN/AL
Jumper	black —

# Passive interfaces (Flat-cable/terminal blocks) CPC Series

- Small size

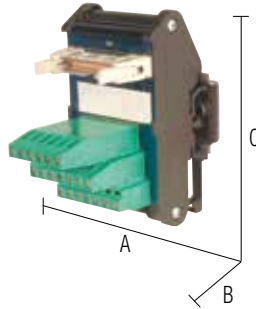

## NOTES

The modules allow signals originating on a flat cable to be transferred to terminal blocks using IDC connectors (with isolation perforation). Numbering is "pin-to-pin".

(1) Version made to order (not kept in stock); contact our sales office for availability.

## BLOCK DIAGRAM

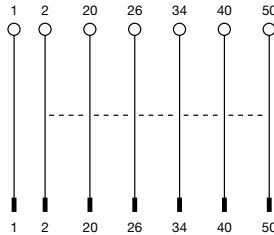

VERSIONS	DIMENSIONS (A x B x C)	Without LED	
		Type	Cat. No.
20 poles	47x80x93	CPC20M	XCPC20M
26 poles	57x80x93	CPC26M	XCPC26M
34 poles	70x80x93	CPC34M (1)	XCPC34M
40 poles	77x80x93	CPC40M	XCPC40M
50 poles	92x80x93	CPC50M (1)	XCPC50M
60 poles	107x80x93	CPC60M (1)	XCPC60M
64 poles	117x80x93	CPC64M (1)	XCPC64M

## GENERAL TECHNICAL DATA

Applicable voltage	0...50 Vac / 0...75 Vdc
Applicable current	750 mA max
Operating temperature range	-20...+60°C
Protection degree	IP00 IEC529; EN60529
Reference Standards	IEC 664-1; DIN VDE 0110.1
Degree of pollution	2
Surge category	II
Housing material	UL94V-0 polyamide
Connection type	2.5 mm <sup>2</sup> fixed screw terminal blocks
Mounting information	vertical on rails, side by side

## MOUNTING ACCESSORIES

Mounting rail compliant with IEC60715/TH35	PR/3/AC - PR/3/AS
Mounting rail type according to IEC60715/G32	PR/DIN/AC - PR/DIN/AS - PR/DIN/AL
Jumper	black —

# Component-holder modules CCM Series

- Small size

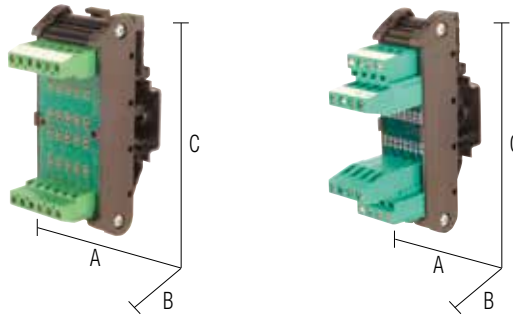

## NOTES

Component-holder modules allow for the mounting of electronic components (diodes, resistors, zener, etc.) by the client. Various configurations are available, with terminal block or flat plug connection and with different sized holes for leading wires of components.

(1) Version made to order (not kept in stock), for information contact our sales office.

## BLOCK DIAGRAM

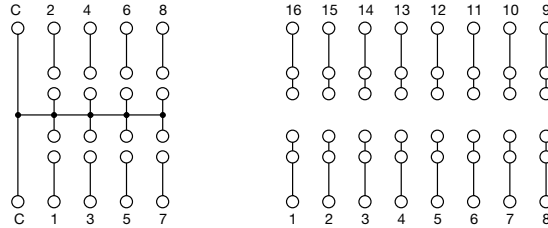

VERSIONS	DIMENSIONS (A x B x C)	with common		single feed-through	
		Type	Cat. No.	Type	Cat. No.
4 components (1)	25x66x93	—	—	—	—
8 components (1)	25x66x93	—	—	CCM08SV	XCCM08SV
8 components (1)	47x66x93	—	—	—	—
8 components (1)	25x55x93	CCM08CV	XCCM08CV	—	—
12 components (1)	70x66x93	—	—	—	—
16 components (1)	47x66x93	CCM16CV	XCCM16CV	CCM16SV	XCCM16SV
24 components (1)	70x66x93	—	—	CCM24SV	XCCM24SV

## GENERAL TECHNICAL DATA

Applicable voltage	0...220 V ±10%	0...100 V ±10%
Applicable current	5 A channel / 15 A on common	4 A max. (on common)
Operating temperature range	-20...+60°C	-20...+60°C
Protection degree	IP00 IEC529; EN60529	IP00 IEC529; EN60529
Reference Standards	IEC 664-1; DIN VDE 0110.1	IEC 664-1; DIN VDE 0110.1
Degree of pollution	2	2
Surge category	II	II
Housing material	UL94V-0 polyamide	UL94V-0 polyamide
Connection type	2.5 mm <sup>2</sup> fixed screw terminal blocks	2.5 mm <sup>2</sup> fixed screw terminal blocks
Mounting information	vertical on rails, side by side	vertical on rails, side by side

## MOUNTING ACCESSORIES

Mounting rail compliant with IEC60715/TH35	PR/3/AC - PR/3/AS
Mounting rail type according to IEC60715/G32	PR/DIN/AC - PR/DIN/AS - PR/DIN/AL
Jumper	black

# Feed-through diode modules CDM Series

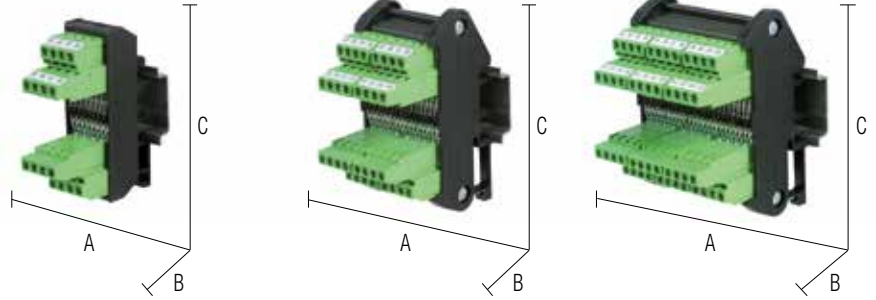

## NOTES

## BLOCK DIAGRAM

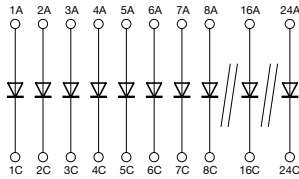

VERSIONS	DIMENSIONS (A x B x C)	feed-through diodes	
		Item	Cat. No.
8 diodes	25x60x76	CDM08CS	XCDM08CS
16 diodes	50x65x93	CDM16CS	XCDM16CS
24 diodes	71x65x93	CDM24CS	XCDM24CS

GENERAL TECHNICAL DATA	
Applicable voltage	0...100 V ±10%
Applicable current	1 A max
Diodes used	1N4007
Max inverse voltage	1000 V
Operating temperature range	-20...+60°C
Protection degree	IP00 IEC529; EN60529
Reference Standards	IEC 664-1; DIN VDE 0110.1
Degree of pollution	2
Surge category	II
Housing material	UL94V-0 polyamide
Connection type	2.5 mm <sup>2</sup> fixed screw terminal blocks
Mounting information	vertical on rails, side by side

MOUNTING ACCESSORIES	
Mounting rail compliant with IEC60715/TH35	PR/3/AC - PR/3/AS
Mounting rail type according to IEC60715/G32	PR/DIN/AC - PR/DIN/AS - PR/DIN/AL
Jumper	—



# Diode modules with common CDM Series

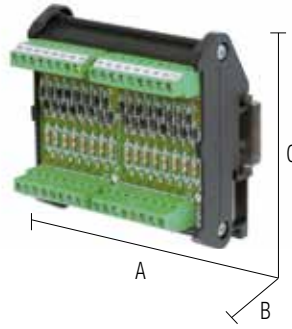

## NOTES

## BLOCK DIAGRAM

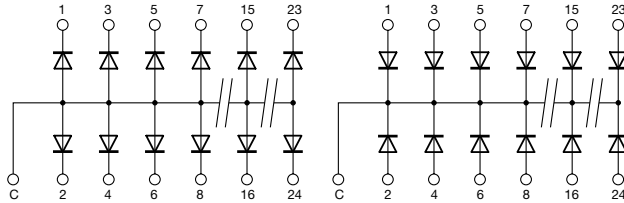

VERSIONS	DIMENSIONS (A x B x C)	common anode		common cathode	
		Type	Cat. No.	Type	Cat. No.
8 diodes	45x65x93	CDM08AC	XCDM08AC	CDM08CC	XCDM08CC
16 diodes	92x65x93	CDM16AC	XCDM16AC	CDM16CC	XCDM16CC
24 diodes	137x65x93	CDM24AC	XCDM24AC	CDM24CC	XCDM24CC

## GENERAL TECHNICAL DATA

Applicable voltage	0...220 V ±10%
Applicable current	1 A channel / 15 A on common
Operating temperature range	1N4007
Diodes used	1000 V
Max inverse voltage	-20...+60°C
Protection degree	IP00 IEC529; EN60529
Reference Standards	IEC 664-1; DIN VDE 0110.1
Degree of pollution	2
Surge category	II
Housing material	UL94V-0 polyamide
Connection type	2.5 mm <sup>2</sup> fixed screw terminal blocks
Mounting information	vertical on rails, side by side

## MOUNTING ACCESSORIES

Mounting rail compliant with IEC60715/TH35	PR/3/AC - PR/3/AS
Mounting rail type according to IEC60715/G32	PR/DIN/AC - PR/DIN/AS - PR/DIN/AL
Jumper	black

# LED testing modules CLT Series

- Compact dimensions
- Integrated limitation resistance
- Suitable only for LEDs without limitation resistance
- Not suitable for LED lamps fitted with an integrated limitation circuit

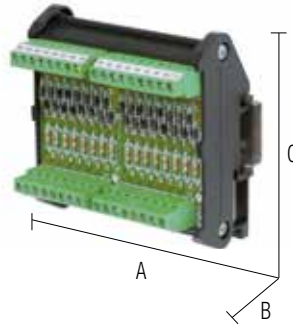

## NOTES

- (1) LED test is conducted on a negative signal on the common
- (2) LED test is conducted on a positive signal on the common
- (3) Version made to order (not kept in stock); contact our sales office for availability.

Some LED lamps are equipped with an internal electronic circuit to adjust the rated voltage. In some cases this circuit will not work correctly if connected in series to a diode, therefore these lamps are not suitable for use with LED test modules or LED test.

## BLOCK DIAGRAM

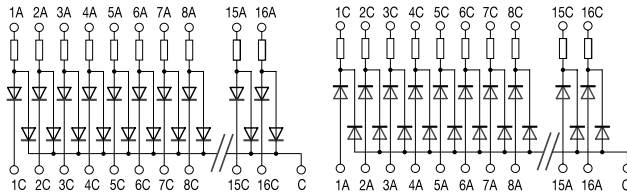

VERSIONS	DIMENSIONS (A x B x C)	common negative(1)		common positive(2)	
		Type	Cat. No.	Type	Cat. No.
8 channels	45x65x93	CLT08AC (3)	XCLT08AC	CLT08CC (3)	XCLT08CC
16 channels	92x65x93	CLT16AC (3)	XCLT16AC	CLT16CC (3)	XCLT16CC

## GENERAL TECHNICAL DATA

Applicable voltage	24 Vdc max 30 Vdc
Single channel current	5 mA at 24 Vdc
Diodes used	1N4007
Limitation resistance	4.7 kΩ 1/4 W ±5%
Max inverse voltage	1000 V
Operating temperature range	-20...+45°C
Housing material	UL94V-0 polyamide
Protection degree	IP 00 IEC529, EN60529
Connection type	2.5 mm <sup>2</sup> fixed screw
Mounting information	vertical on rails, side by side

## MOUNTING ACCESSORIES

Mounting rail compliant with IEC60715/TH35	PR/3/AC – PR/3/AC/ZB – PR/3/AS – PR/3/AS/ZB
Mounting rail type according to IEC60715/G32	PR/DIN/AC – PR/DIN/AS – PR/DIN/AL
Jumper	black

# Lamp testing modules CLP Series

- Compact dimensions
- Suitable for LED lamps with limitation resistance

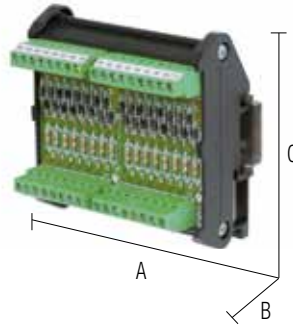

## NOTES

If using modules in alternating current, power is halved due to the presence of rectifier diodes.

- (1) Lamp test is conducted on a negative signal on the common
- (2) Lamp test is conducted on a positive signal on the common

## BLOCK DIAGRAM

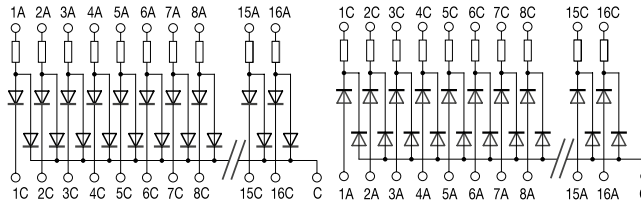

VERSIONS	DIMENSIONS (A x B x C)	common negative(1)		common positive(2)	
		Type	Cat. No.	Type	Cat. No.
8 channels	45x65x93			CLP08CC	XCLP08CC
16 channels	92x65x93			CLP16CC	XCLP16CC

## GENERAL TECHNICAL DATA

Applicable voltage	230 Vac/dc
Single channel current	100 mA at 120 Vac/dc; 50 mA at 230 Vac/dc
Diodes used	1N4007
Limitation resistance	0
Max inverse voltage	1000 V
Operating temperature range	-20...+45°C
Housing material	UL94V-0 polyamide
Protection degree	IP 00 IEC529, EN60529
Connection type	2.5 mm <sup>2</sup> fixed screw
Mounting information	vertical on rails, side by side

## MOUNTING ACCESSORIES

Mounting rail compliant with IEC60715/TH35	PR/3/AC – PR/3/AC/ZB – PR/3/AS – PR/3/AS/ZB
Mounting rail type according to IEC60715/G32	PR/DIN/AC - PR/DIN/AS - PR/DIN/AL
Jumper	black

# Electronic circuit housing CH Series

- Modular in 3 sizes

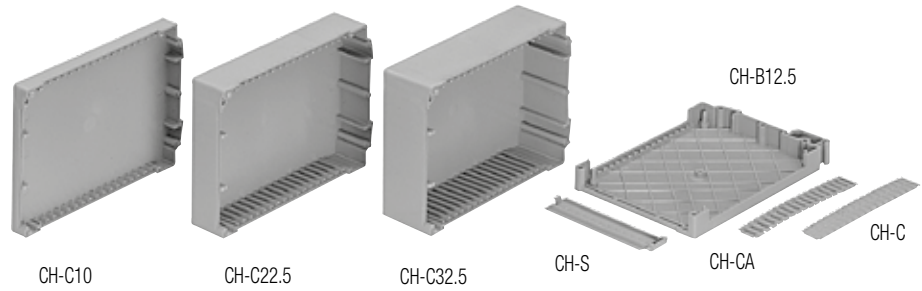

## NOTES

(1) Maximum height of components measured between circuit and cover

## BLOCK DIAGRAM

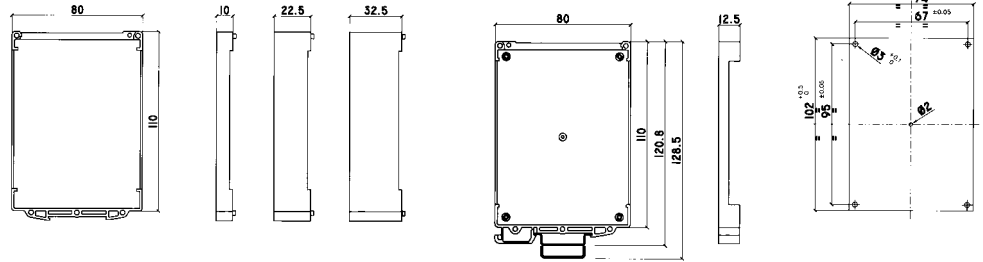

## VERSIONS

12.5 mm DIN-rail mounting base
10 mm cover
22.5 mm cover
32.5 mm cover
openable front closure
aerated closure
non-aerated closure

## Type

CH-B12.5
CH-C10
CH-C22.5
CH-C32.5
CH-S
CH-CA
CH-C

## Cat. No.

XBB125
XBC010
XBC225
XBC325
XBS000
XBCA00
XBC000

## APPLICATIONS

### Electronic circuit for housing CH Series

With its CH (Cabur Housing) series containers, Cabur offers a modular system for creating three different sized boxes (22.5 mm, 35 mm and 45 mm) made up of eight easily assemble parts.

The circuit can measure up to 102 x 74 mm and can be inserted onto four columns in the base which hold it in place.

The circuit can be additionally secured with a 2.2 x 4.5 mm self-tapping screw, to be screwed into the central column, which also enables the circuit to be smaller in size.

Conductor connections are applied using 2.5 mm removable terminal blocks, which are easily available.

16 connection poles are used, with a clearance of 5.08 mm on each side and 10 mm on the front.

The CH-S front closure has an openable inspection window for access to inside the circuit for procedures on potentiometers, jumpers and microswitches.

The side closures have a number of incisions which enable them to be cut off with scissors, at a clearance of 5.08 mm, avoiding the expensive grinding typical of other models on the market.

Housing requires the following components:

- 1 CH-B12.5 base width 12.5 mm
- 1 cover (3 available sizes)
 

CH-C10	width 10 mm
CH-C22.5	width 22.5 mm
CH-C32.5	width 32.5 mm

(the total housing width is obtained by adding the width of the base (12.5 mm) to the width of the cover selected from the 4 available sizes)

- 1 front closure, available in two versions:
 

CH-S	openable window
CH-CF	fixed
- 2 side closures, available in two versions:
 

CH-C	without aeration holes
CH-CA	with aeration holes

## GENERAL TECHNICAL DATA

Material	UL94V-0 polyamide
Colour	RAL 5014
Temperature	max 80 °C
Dissipated power	max 7 W
Protection degree	up to IP30
Number of poles per side	16 +16 (5.08)
Number of front poles	10 (5.08)
Mounting information	

## MOUNTING ACCESSORIES

Mounting rail compliant with IEC60715/TH35-7.5

Mounting rail compliant with IEC60715/G32

Jumper	red	—
	white	—
	blue	—

## PR/3/AC, PR/3/AS

Max internal height (1)	CH-B12.5	CH-C10	CH-C22.5	CH-C32.5	CH-S	CH-CA CH-C
19.1 mm	1	1			1	2
31.6 mm	1		1		1	2
41.6 mm	1			1	1	2

# Electronic circuit housing CK Series

- Expandable cards with 6 mm clearance
- 6 x 2.5 mm<sup>2</sup> spring terminal blocks on both the base and the expansions
- Jumper can be connected on all 4 levels
- Openable front inspection window

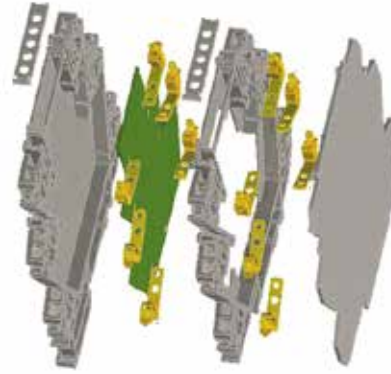

## NOTES

- (1) Includes 6 spring terminal blocks with weldable contact
- (2) The final module must always be protected with the CK/PT terminal wall to ensure protection degree IP20.

## BLOCK DIAGRAM

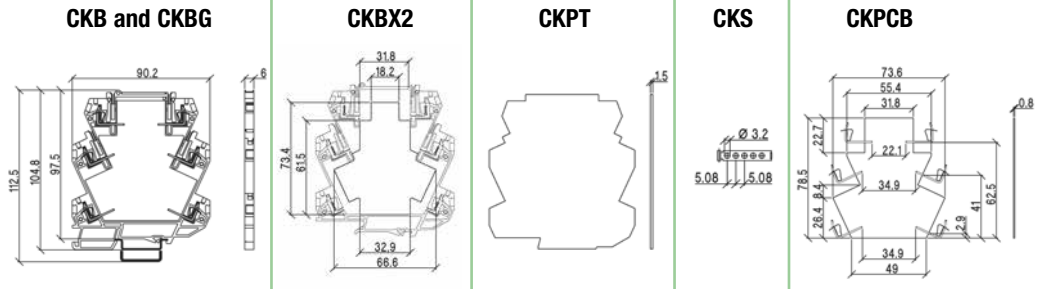

## VERSIONS

- base housing
- base housing with ground contact
- expansion module
- end section
- openable inspection window
- printed circuit board

## Type

Type	Cat. No.
<b>CKB (1)</b>	<b>XCKB</b>
<b>CKBG (1)</b>	<b>XCKBG</b>
<b>CKBX2 (1)</b>	<b>XCKX2</b>
<b>CK/PT</b>	<b>XCKPT</b>
<b>CK/S</b>	<b>XCKS</b>
<b>CK/PCB</b>	<b>8901028</b>

## APPLICATIONS

With its CK series housing, Cabur offers a modular system for creating terminal blocks of gradually increasing widths for housing simple components such as diodes and resistors or more complex circuits with or without the support of a printed circuit board.

Housing requires the following components:

- one base housing available in two versions: CKB and CKBG, the latter supplied with an electrical contact to the metal rail for connecting the internal circuit to ground. The rail ground contact can carry an impulse current of 5 KA (impulse 8/20). Both models have an external width of 6 mm and an internal width of 5 mm and have 6 spring connections, 4 of which are connectable to a jumper.
- one or more CKBX2 expansion cards similar to the standard model, i.e. with an external width of 6 mm and a central cavity that allows bulky components to overlap the base outline, can also be supplied with a 6-connection expansion, 4 of which connectable to a jumper;
- available with the CK/S openable inspection window for frontal closure; the opening is in any case sized to ensure protection degree IP20 even without using the inspection window;
- the final module must be provided with the CK/PT end section, which ensures protection degree IP20;
- also available with the CK/PCB printed strip board, useful for custom applications in which low volumes make it infeasible to produce a dedicated printed circuit board or for creating affordable prototypes.

## GENERAL TECHNICAL DATA

- Voltage distributable to the jumper
- Current distributable to the jumper
- Operating temperature range
- Protection degree (2)
- Connection terminal blocks
- Housing material
- Approximate weight
- Jumper
- Marking tag

Voltage distributable to the jumper	230 Vac/dc ± 10%
Current distributable to the jumper	≤ 24 A
Operating temperature range	-40...+ 100°C
Protection degree (2)	IP20 IEC529 EN60529
Connection terminal blocks	2.5 mm <sup>2</sup> , AWG26-14 spring
Housing material	UL94V-0 polyamide
Approximate weight	20 g (CKB, CKBG), 15 g (CKX2, CK/PT) 20 g (CK/PT), 1 g (CK/S), 5 g (CK/PCB)
Jumper	PTC/CK/42 cat. no. PTCCK42 (42 poles)
Marking tag	CNU/8/030 cat. no. NU0851

## Mounting information

- Mounting rail compliant with IEC60715/TH35-7.5
- Mounting rail compliant with IEC60715/G32

Mounting information	on rails
Mounting rail compliant with IEC60715/TH35-7.5	<b>PR/3/AC, PR/3/AC/ZB, PR/3/AS, PR/3/AS/ZB</b>
Mounting rail compliant with IEC60715/G32	—

## MOUNTING ACCESSORIES

- Jumper

Jumper	red white blue
--------	----------------------

Ground contact on CKBG



CKBX2



CKB

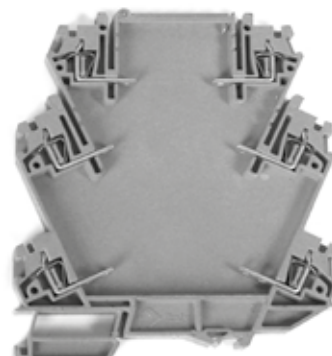

CK/PCB

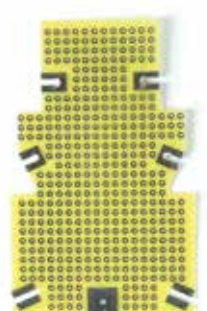

## “CK” Series accessories PTC/CK/42 jumper

### Notes:

- (1) Example of a bridge cut into nine poles
- (2) Protection degree refers to the bridge installed following the applicable instructions
- (3) Capacity allows for a maximum current of 32 A, limited to the capacity of the 24 A terminal block, therefore in a plug-in jumper of e.g. 11 poles (1 common and 10 distribution) 2.4 A can be distributed per pole.



VERSIONS		Type	Cat. No.
		PTC/CK/42	PTCCK42
GENERAL TECHNICAL DATA			
Protection degree (2)	IP20 IEC529; EN60529		
Number of poles	42		
Pitch	6 mm		
Bridge current capacity (3)	32 A		
Isolation colour	—		
Material	copper-tin alloy		
Approximate weight	27 g (42 poles)		

## “CW..7” Series accessories CWBK Series jumpers



VERSIONS	Type	Cat. No.	Type	Cat. No.	Type	Cat. No.
	CWBK 7-0802	X766802	CWBK 7-0803	X766803	CWBK 7-0804	X766804
GENERAL TECHNICAL DATA						
Protection degree	IP20 IEC529; EN60529		IP20 IEC529; EN60529		IP20 IEC529; EN60529	
Number of poles	16		16		16	
Pitch	6.2 mm		6.2 mm		6.2 mm	
Jumper current capacity	16 A		16 A		16 A	
Isolation colour	red		white		blue	
Material	—		—		—	
Approximate weight	4 g		4 g		4 g	

## “CWRE” Series accessories Jumpers CWBK Series



VERSIONS	Type	Cat. No.
	CWBK 7-0813	X766813
GENERAL TECHNICAL DATA		
Protection degree	IP20 IEC529; EN60529	
Number of poles	20	
Pitch	6.2 mm	
Jumper current capacity	16 A	
Isolation colour	blue	
Material	—	
Approximate weight	6 g	

## “CM” Series accessories CMB Series jumpers



VERSIONS	Type	Cat. No.	Type	Cat. No.
	CMB16B	XCMB16B	CMB27B	XCMB27B

GENERAL TECHNICAL DATA				
Protection degree	IP20 IEC529; EN60529		IP20 IEC529; EN60529	
Number of poles	8		8	
Pitch	16 mm		27 mm	
Jumper current capacity	16 A		16 A	
Isolation colour	black		black	
Material	—		—	
Approximate weight	3 g		3 g	

## Marking systems

### Notes:

White polyamide marking tags to number the terminal blocks of the CK Series cards and CWRE Series converters. To be directly inserted in dedicated holders before or after rail mounting preparation.

They come in packages of 15 cards of 100 marking tags each, for a total of 1,500 marking tags.

The table shows only blank marking tags, available in packages of 1,500 pieces each, which can be written on manually using special pens or printed using an industrial marking system. In particular, the marking tags shown here can be **printed using the innovative CaburJet system and with the CaburPlot plotter.**

In addition to blank marking tags, CNU/8/51 preprinted marking tags are also available with alpha-numeric characters and with the most common electrical symbols.

For more information, please consult the Industrial Marking Systems catalogue.

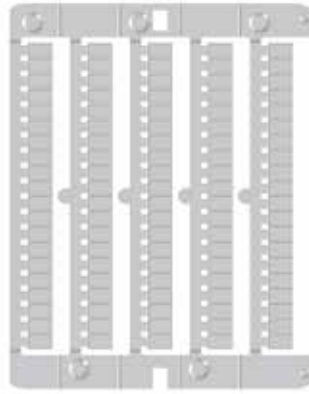

Type **CNU/8/51** Cat. No. NU0851

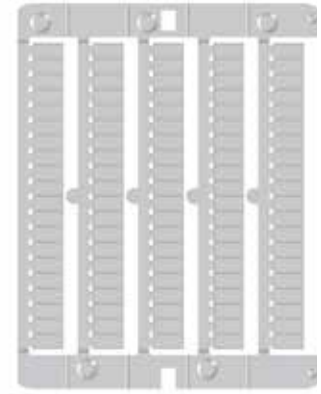

Type **NUPUTUK50** Cat. No. NUPUTUK50

Description	Type	Cat. no.
Marking tags for marking CK Series cards	<b>CNU/8/51</b>	NU0851
Marking tags for marking CWRE Series converters	<b>NUPUTUK50</b>	NUPUTUK50

## Power supply mounting bracket

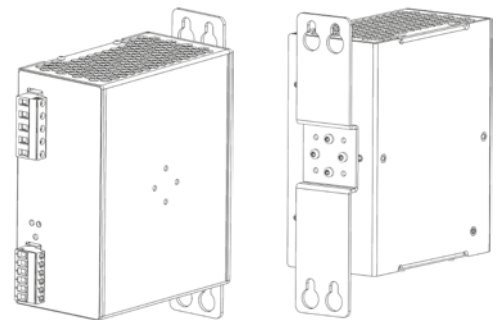

VERSIONS	Type	Cat. No.	DIMENSIONS
	CDIWMP	XCDIWMP	

GENERAL TECHNICAL DATA			
Type of material	P13-FE00 aluminium		
Treatment	Sendzimir zinc coating		
Mounting information	screws or rivets		

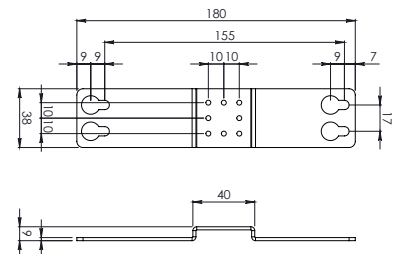



# DIN rail clamp



## DIMENSIONS

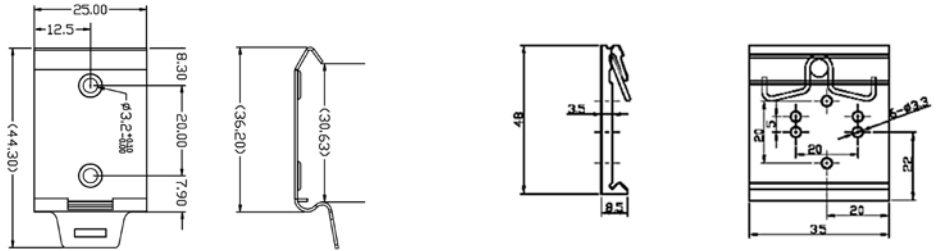

VERSIONS	Type	Cat. No.	Type	Cat. No.
	CDIN-2	XCDIN2	CDIN-4	XCDIN4

## GENERAL TECHNICAL DATA

Type of material	P13-FE00	aluminium
Treatment	black zinc coating	—
Mounting information	screws or rivets	screws or rivets
Mounting rail compliant with IEC60715/TH35-7.5	<b>PR/3/AC, PR/3/AC/ZB, PR/3/AS, PR/3/AS/ZB</b>	<b>PR/3/AC, PR/3/AC/ZB, PR/3/AS, PR/3/AS/ZB</b>
Mounting rail compliant with IEC60715/G32	—	—



## DIMENSIONS

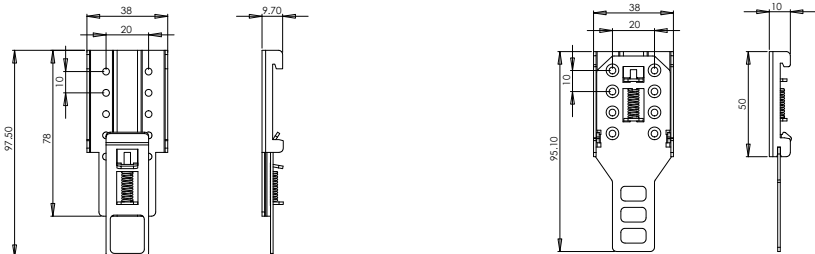

VERSIONS	Type	Cat. No.	Type	Cat. No.
	CDIN-6	XCDIN6	CDINM4	XCDINM4

## GENERAL TECHNICAL DATA

Type of material	P13-FE00	P13-FE00
Treatment	white zinc coating	zinc coating
Mounting information	screws or rivets	screws
Mounting rail compliant with IEC60715/TH35-7.5	<b>PR/3/AC, PR/3/AC/ZB, PR/3/AS, PR/3/AS/ZB</b>	<b>PR/3/AC, PR/3/AC/ZB, PR/3/AS, PR/3/AS/ZB</b>
Mounting rail compliant with IEC60715/G32	—	—

## Mounting rails

- conforming to IEC 60715/TH35 - 7.5
- conforming to IEC 60715/TH35 - 15
- supports for TH/35 rail



DESCRIPTION	TYPE/CAT. NO.	DIAGRAMS
<b>Rail compliant with IEC 60715/TH35 - 7.5</b> in passivated steel	<b>PR/3/AC</b> Cat. No. PR003	
<b>Rail compliant with IEC 60715/TH35 - 7.5</b> in white zinc-plated steel "SENDZMIR" system	<b>PR/3/AC/ZB</b> Cat. No. PR903	
<b>Rail compliant with IEC 60715/TH35 - 7.5</b> in passivated steel with slots	<b>PR/3/AS</b> Cat. No. PR005	
<b>Rail compliant with IEC 60715/TH35 - 7.5</b> in white zinc-plated steel "SENDZMIR" system with slots	<b>PR/3/AS/ZB</b> Cat. No. PR905	
<b>Rail compliant with IEC 60715/TH35 - 15</b> in passivated steel	<b>PR/3/PP</b> Cat. No. PR007	
<b>Rail compliant with IEC 60715/TH35 - 15</b> in white zinc-plated steel "SENDZMIR" system	<b>PR/3/PP/ZB</b> Cat. No. PR907	
<b>Rail compliant with IEC 60715/TH35 - 15</b> in passivated steel with slots	<b>PR/3/PA</b> Cat. No. PR006	
<b>Rail compliant with IEC 60715/TH35 - 15</b> in white zinc-plated steel "SENDZMIR" system with slots	<b>PR/3/PA/ZB</b> Cat. No. PR906	
<b>Support for rails IEC 60715/TH35</b> in nickel plated steel with rapid mounting system 4 MA	<b>ACI121017</b> Cat. No. Z121017	
<b>Support for rails IEC 60715/TH35</b> in nickel plated steel with rapid mounting system 5 MA	<b>ACI121019</b> Cat. No. Z121019	

## Mounting rails

- conforming to IEC 60715/TH35 - 7.5 "G32" type
- conforming to IEC 60715/TH15 - 5.5



DESCRIPTION	TYPE/CAT. NO.	DIAGRAMS
<b>Rail compliant with IEC 60715 "G32" type</b> in passivated steel	<b>PR/DIN/AC</b> Cat. No. PR001	
<b>Rail compliant with IEC 60715 "G32" type</b> in white zinc-plated steel "SENDZMIR" system	<b>PR/DIN/AC/ZB</b> Cat. No. PR901	
<b>Rail compliant with IEC 60715 "G32" type</b> in passivated steel with slots	<b>PR/DIN/AS</b> Cat. No. PR004	
<b>Rail compliant with IEC 60715 "G32" type</b> in white zinc-plated steel "SENDZMIR" system with slots	<b>PR/DIN/AS/ZB</b> Cat. No. PR904	
<b>Rail compliant with IEC 60715 "G32" type</b> in aluminium	<b>PR/DIN/AL</b> Cat. No. PR002	
<b>Rail compliant with IEC 60715/TH15 - 5.5</b> in passivated steel	<b>PR/2/AC</b> Cat. No. PR009	
<b>Rail compliant with IEC 60715/TH15 - 5.5</b> in white zinc-plated steel "SENDZMIR" system	<b>PR/2/AC/ZB</b> Cat. No. PR909	
<b>Rail compliant with IEC 60715/TH15 - 5.5</b> in passivated steel with slots	<b>PR/2/AS</b> Cat. No. PR010	
<b>Rail compliant with IEC 60715/TH15 - 5.5</b> in white zinc-plated steel "SENDZMIR" system with slots	<b>PR/2/AS/ZB</b> Cat. No. PR910	

# Type index

ID NUMBER	PAGE	ID NUMBER	PAGE	ID NUMBER	PAGE	ID NUMBER	PAGE	ID NUMBER	PAGE
AR6	42	CM1A012	91	CSD30E	12	CWBK7-0802	130	ISD09FM	119
CAPIPO3	67	CM1A024	91	CSD30F	12	CWBK7-0803	130	ISD09PF	119
CCIS2	79	CM1A120	91	CSD50B	13	CWBK7-0804	130	ISD09PM	119
CCM08CV	123	CM1A230	91	CSD70C	14	CWBK7-0813	130	ISD15FM	119
CCM08SV	123	CM1C012	88	CSF120C	18	CWCV7-6184	83	ISD15PF	119
CCM16CV	123	CM1C024	88	CSF120CP	18	CWNAA7-0539	69	ISD15PM	119
CCM16SV	123	CM1C048	88	CSF120DP	18	CWNFA6-0524	82	ISD25FM	119
CCM24SV	123	CM1C110	88	CSF240C	19	CWOT6-2082	113	ISD25PF	119
CDIN-2	132	CM1S024	108	CSF240CP	19	CWOT6-2083	112	ISD25PM	119
CDIN-4	132	CM1S024E	108	CSF240DP	19	CWPAA7-0526	73	ISD37FM	119
CDIN-5	132	CM1T024	109	CSF30C	16	CWPAA7-0527	73	ISD37PF	119
CDINM45	132	CM1T024E	109	CSF500C	20	CWPT6-0816	77	ISD37PM	119
CDM08AC	125	CM2A012	92	CSF500D	20	CWRE7-0842	95	LCONALSFDT	74
CDM08CC	125	CM2A024	92	CSF5-65	21	CWRE7-0845	95	LCONTADFDT	75
CDM08CS	124	CM2A120	92	CSF85B	17	CWRE7-0846	95	LCONTLSFDT	76
CDM16AC	125	CM2A230	92	CSF85C	17	CWRE7-0847	95	LCONZBUSB	74
CDM16CC	125	CM2C012	89	CSF85CP	17	CWRE7-0848	95	MBC2K	51
CDM16CS	124	CM2C024	89	CSG2401C	37	CWTH6-0844	78	NUPUTUK50	131
CDM24AC	125	CM2C048	89	CSG2401D	37	CWUAA6-0516	68	O332060	107
CDM24CC	125	CM2C110	89	CSG2401G	38	F03DKBG5B	61	O332240	107
CDM24CS	124	CM4C024	90	CSG2401R	38	F03DPCG5C	62	PTC/CK/42	130
CEP-BCB	53	CMB27B	131	CSG481C	33	F06DKBG5B	61	R161E24	97
CEP-BCR	53	CNU/8/51	131	CSG500C	34	F06DPCG5C	62	R161EAD	98
CEP-D1	53	COP082	117	CSG500G	34	F07TDVST2	55	R161S24F	116
CEP-D2	53	CPC20M	122	CSG720C	35	F100TDVST2	55	R161U24F	99
CEP-MTW	53	CPC26M	122	CSG720D	35	F100TYT8	59	R162E24	100
CEP-RCC	53	CPC34M	122	CSG960C	36	F10TYG9	60	R162EAD	101
CEP-RCP	53	CPC40M	122	CSG960D	36	F12DKBG5B	61	R162S24	114
CEP-SS	53	CPC50M	122	CSG960G	36	F12DPCG5C	62	R162T24	115
CH-B12.5	128	CPC60M	122	CSL120C	24	F150TDS84C	56	R41E24	97
CH-C	128	CPC64M	122	CSL240C	25	F16DKCG5B	61	R41EAD	98
CH-C10	128	CPD25F	120	CSL481C	26	F16DPCG5C	62	R41S24F	116
CH-C22.5	128	CPD25M	120	CSL85C	23	F16TDVST2	55	R41U24F	99
CH-C32.5	128	CPD37F	120	CSR50U	49	F16TYT8	59	R42E24	100
CH-CA	128	CPD37M	120	CSU0120S	45	F180TDS84C	56	R42EAD	101
CH-S	128	CPD50F	120	CSU240S	46	F200TDDS84C	57	R42S24	114
CI-NPN/PNP	84	CPD50M	120	CS-UPS1	44	F20DKCG5B	61	R42T24	115
CK/S	129	CR4-1	103	CS-UPS2	44	F20DPCG5C	62	R81E24	97
CKB	129	CR4-2SC	104	CSW121B	28	F20TYS9	60	R81EAD	98
CKBG	129	CR8-1	103	CSW121C	28	F25TYT8	59	R81S24F	116
CKBX2	129	CR8-3	105	CSW241B	29	F300TDDS84C	58	R81U24F	99
CK-PCB	129	CRE4-1	103	CSW241C	29	F30DKCS5B	61	R82E24	100
CKR16	94	CRE4-2SC	104	CSW241DP	29	F30DPCS5C	62	R82EAD	101
CKR25	94	CRE8-1	103	CSW241G	29	F30TDVST2	55	R82S24	114
CKS024DC024DC03	110	CRE8-3	105	CSW481C	30	F36TYT8	59	R82T24	115
CKS024DC024DC05	110	CSA120BC	39	CSW481D	30	F400TDDS84C	58	RE1024D	86
CKS024DC024DC10	110	CSA120CB	39	CSW481G	30	F42TDVST2	55	RE1824D	86
CKS024DC230AC05	111	CSA120CC	39	CSW960CP	31	F50TYT8	59	RE2024D	87
CKS1S	113	CSA120DC	39	CWAA7-0530	70	F55TDVST2	55	RF1024D	86
CL1R	41	CSA240FC	40	CWAA7-0531	70	F75TDVST2	55	RF1824D	86
CL5R	41	CSBC	43	CWAA7-0532	70	IF10PML	120	RFA024D	86
CLP08CC	127	CSBD	48	CWAA7-0533	71	IF14PML	121	RMP081CM	102
CLP16CC	127	CSC120B	47	CWAA7-0534	71	IF16PML	121	SW50VA	81
CLT08AC	126	CSC120C	47	CWAA7-0535	71	IF20PML	121	WAA7-0540	80
CLT08CC	126	CSD15B	11	CWAA7-0536	72	IF26PML	121	WAA7-0541	80
CLT16AC	126	CSD15C	11	CWAA7-0537	72	IF34PML	121	WAA7-0542	80
CLT16CC	126	CSD30C	12	CWAA7-0538	72	IF40PML	121		

# Index by Catalogue number

CODE	PAGE	CODE	PAGE	CODE	PAGE	CODE	PAGE	CODE	PAGE
PTCCK42	130	XCDM08CC	125	XCMB16B	131	XCSG481C	33	XF75TDVST2	55
X756340	75	XCDM08CS	124	XCMB27B	131	XCSG500C	34	XIF10PML	120
X756360	74	XCDM16AC	125	XCOP082	117	XCSG500G	34	XIF14PML	121
X756370	76	XCDM16CC	125	XCPC20M	122	XCSG720C	35	XIF16PML	121
X756516	68	XCDM16CS	124	XCPC26M	122	XCSG720D	35	XIF20PML	121
X756524	82	XCDM24AC	125	XCPC34M	122	XCSG960C	36	XIF26PML	121
X756526	73	XCDM24CC	125	XCPC40M	122	XCSG960D	36	XIF34PML	121
X756527	73	XCDM24CS	124	XCPC50M	122	XCSG960G	36	XIF40PML	121
X756530	70	XCEPBCB	53	XCPC60M	122	XCSL120C	24	XISD09FM	119
X756531	70	XCEPBCR	53	XCPC64M	122	XCSL240C	25	XISD09PF	119
X756532	70	XCEPD1	53	XCPD25F	120	XCSL481C	26	XISD09PM	119
X756533	71	XCEPD2	53	XCPD25M	120	XCSL85C	23	XISD15FM	119
X756534	71	XCEPMTW	53	XCPD37F	120	XCSR50U	49	XISD15PF	119
X756535	71	XCEPRCC	53	XCPD37M	120	XCSU0120S	45	XISD15PM	119
X756536	72	XCEPRCP	53	XCPD50F	120	XCSU240S	46	XISD25FM	119
X756537	72	XCEPSS	53	XCPD50M	120	XCSUPS1	44	XISD25PF	119
X756538	72	XCKB	129	XCR41	103	XCSUPS2	44	XISD25PM	119
X756539	69	XCKBG	129	XCR42SC	104	XCSW121B	28	XISD37FM	119
X756540	80	XCKPT	129	XCR81	103	XCSW121C	28	XISD37PF	119
X756541	80	XCKR16	94	XCR83	105	XCSW241B	29	XISD37PM	119
X756542	80	XCKR25	94	XCRE41	103	XCSW241C	29	XMBC2K	51
X756816	77	XCKS	129	XCRE42SC	104	XCSW241DP	29	XNPNP	84
X756844	78	XCKS024DC024DC03	110	XCRE81	103	XCSW241G	29	X0332060	107
X756894	74	XCKS024DC024DC05	110	XCRE83	105	XCSW481C	30	X0332240	107
X766082	113	XCKS024DC024DC10	110	XCSA120BC	39	XCSW481D	30	XR041E24	97
X766083	112	XCKS024DC230AC05	111	XCSA120CB	39	XCSW481G	30	XR041EAD	98
X766184	83	XCKS1S	113	XCSA120CC	39	XCSW960CP	31	XR041S24F	116
X766802	130	XCKX2	129	XCSA120DC	39	XF03DKBG5B	61	XR041U24F	99
X766803	130	XCL1R	41	XCSA240FC	40	XF03DPCG5C	62	XR042E24	100
X766804	130	XCL5R	41	XCSBC	43	XF06DKBG5B	61	XR042EAD	101
X766813	130	XCLP08CC	127	XCSBD	48	XF06DPCG5C	62	XR042S24	114
X766842	95	XCLP16CC	127	XCSC120B	47	XF07TDVST2	55	XR042T24	115
X766845	95	XCLT08AC	126	XCSC120C	47	XF100TDVST2	55	XR081E24	97
X766846	95	XCLT08CC	126	XCSD15B	11	XF100TYT8	59	XR081EAD	98
X766847	95	XCLT16AC	126	XCSD15C	11	XF10TYG9	60	XR081S24F	116
X766848	95	XCLT16CC	126	XCSD30C	12	XF12DKBG5B	61	XR081U24F	99
XAR6	42	XCM1A012	91	XCSD30E	12	XF12DPCG5C	62	XR082E24	100
XBB125	128	XCM1A024	91	XCSD30F	12	XF150TDS84C	56	XR082EAD	101
XBC000	128	XCM1A120	91	XCSD50B	13	XF16DKCG5B	61	XR082S24	114
XBC010	128	XCM1A230	91	XCSD70C	14	XF16DPCG5C	62	XR082T24	115
XBC225	128	XCM1C012	88	XCSF120C	18	XF16TDVST2	55	XR161E24	97
XBC325	128	XCM1C024	88	XCSF120CP	18	XF16TYT8	59	XR161EAD	98
XBCA00	128	XCM1C048	88	XCSF120DP	18	XF180TDS84C	56	XR161S24F	116
XBS000	128	XCM1C110	88	XCSF240C	19	XF200TDDS84C	57	XR161U24F	99
XCAPIPO3	67	XCM1S024	108	XCSF240CP	19	XF20DKCG5B	61	XR162E24	100
XCCIS2	79	XCM1S024E	108	XCSF240DP	19	XF20DPCG5C	62	XR162EAD	101
XCCM08CV	123	XCM1T024	109	XCSF30C	16	XF20TYS9	60	XR162S24	114
XCCM08SV	123	XCM1T024E	109	XCSF500C	20	XF25TYT8	59	XR162T24	115
XCCM16CV	123	XCM2A012	92	XCSF500D	20	XF300TDS84C	58	XRE1024D	86
XCCM16SV	123	XCM2A024	92	XCSF565	21	XF30DKCS5B	61	XRE1824D	86
XCCM24SV	123	XCM2A120	92	XCSF85B	17	XF30DPCG5C	62	XRE2024D	87
XCDIN2	132	XCM2A230	92	XCSF85C	17	XF30TDVST2	55	XRF1024D	86
XCDIN4	132	XCM2C012	89	XCSF85CP	17	XF36TYT8	59	XRF1824D	86
XCDIN5	132	XCM2C024	89	XCSG2401C	37	XF400TDS84C	58	XRFA024D	86
XCDINM45	132	XCM2C048	89	XCSG2401D	37	XF42TDVST2	55	XRMP081CM	102
XCDIWMP2	131	XCM2C110	89	XCSG2401G	38	XF50TYT8	59	XW000932	81
XCDM08AC	125	XCM4C024	90	XCSG2401R	38	XF55TDVST2	55		



8 017963 163170



ELECTRONIC PRODUCTS  
FOR ELECTRICAL PANELS



PRODUCTS AND SYSTEMS  
FOR THE CONNECTION  
OF ELECTRICAL PANELS



PHOTOVOLTAIC SYSTEMS  
CONNECTION AND  
PROTECTION



INDUSTRIAL MARKING  
SYSTEMS

D021G17A - 0717 - 2017/2018 EDITION

#### **Cabur Srl**

17041 - Altare (SV)

Località Isola Grande, 45 - Italy

T. +39 019 58999.1

F. +39 019 58999280

[www.cabur.it](http://www.cabur.it)

[info@cabur.it](mailto:info@cabur.it)

#### **Romanian Branch**

Cabur Romania Srl

Strada Calea Plevnei nr. 139

Corp B camera 25,26 sector 6

Bucuresti

T. +40 (21)31.17.140

F. +40 (21)31.17.140

[www.cabur.eu](http://www.cabur.eu)

[alexandru.cazacu@cabur.eu](mailto:alexandru.cazacu@cabur.eu)